

# A11XPY-9

Cooker size	90x60 cm
N. of cavities with energy label	1
Cavity heat source	ELECTRICITY
Hob type	Gas
Type of main oven	Thermo-ventilated
Cleaning system main oven	Pyrolitic
EAN code	8017709272470



## Aesthetics



<b>Aesthetic</b>	Classica	<b>Controls colour</b>	Stainless steel
<b>Series</b>	Opera	<b>Display</b>	CompactScreen
<b>Colour</b>	Stainless steel	<b>Display languages</b>	DA, DE, EN, ES, FR, IT, NL, PL, PT, RU, SV
<b>Finishing</b>	Fingerproof	<b>No. of controls</b>	8
<b>Design</b>	Professional	<b>Serigraphy colour</b>	Black
<b>Door</b>	With 2 horizontal strips	<b>Handle</b>	Smeg Classic
<b>Upstand</b>	Yes	<b>Handle Colour</b>	Brushed stainless steel
<b>Type of pan stands</b>	Cast Iron	<b>Glass type</b>	Eclipse
<b>Hob colour</b>	Stainless steel	<b>Storage compartment</b>	Drawer
<b>Command panel finish</b>	Finger friendly stainless steel	<b>Logo</b>	Assembled st/steel
<b>Control knobs</b>	Smeg Classic	<b>Logo position</b>	Facia below the oven

## Programme / Functions

No. of cooking functions	10
--------------------------	----

### Traditional cooking functions

Static	Fan assisted	Circulaire
Eco	Small grill	Large grill
Fan grill (large)	Base	Fan assisted base
Circulaire + base		

### Cleaning functions

Vapor clean

**Customizable recipes** 10

**Automatic programs** 50

### Other functions

Defrost by time	Defrost by weight	Plate rack/warmer
Proving	Sabbath	

## Hob technical features

<b>Total no. of cook zones</b>	6		
Front left - Gas - 2UR (dual) - 4.20 kW			
Rear left - Gas - Rapid - 3.00 kW			
Front centre - Gas - AUX - 1.00 kW			
Rear centre - Gas - Semi Rapid - 1.80 kW			
Front right - Gas - Semi Rapid - 1.80 kW			
Rear right - Gas - Rapid - 3.00 kW			
<b>Type of gas burners</b>	Standard	<b>Gas safety valves</b>	Yes
<b>Automatic electronic ignition</b>	Yes	<b>Burner caps</b>	Matt black enamelled

## Main Oven Technical Features

<b>No. of lights</b>	2	<b>Net volume of the cavity</b>	115 l	<b>Cavity material</b>	Ever Clean enamel	<b>No. of shelves</b>	5	<b>Total no. of door glasses</b>	3	<b>Safety Thermostat</b>	Yes	<b>Cooling system</b>	Tangential
<b>Fan number</b>	3	<b>Gross volume, 1st cavity</b>	126 l	<b>No. of shelves</b>	5	<b>Type of shelves</b>	Metal racks	<b>No. of thermo-reflective door glasses</b>	2	<b>Heating suspended when door is opened</b>	Yes		
<b>Light type</b>	Halogen												

<b>Light Power</b>	40 W	<b>Usable cavity space dimensions (HxWxD)</b>	371x724x418 mm
<b>Cooking time setting</b>	Start and Stop	<b>Temperature control</b>	Electronic
<b>Light when oven door is open</b>	Yes	<b>Lower heating element power</b>	1700 W
<b>Door opening</b>	Flap down	<b>Upper heating element - Power</b>	1200 W
<b>Removable door</b>	Yes	<b>Grill element</b>	1700 W
<b>Full glass inner door</b>	Yes	<b>Large grill - Power</b>	2900 W
<b>Removable inner door</b>	Yes	<b>Circular heating element - Power</b>	1500 W
		<b>Grill type</b>	Electric
		<b>Tilting grill</b>	Yes
		<b>Soft Close system</b>	Yes

## Options Main Oven

<b>Timer</b>	Yes	<b>Minimum Temperature</b>	50 °C
<b>End of cooking acoustic alarm</b>	Yes	<b>Maximum temperature</b>	250 °C

## Accessories included for Main Oven & Hob



<b>Cast iron wok support</b>	1	<b>40mm deep tray</b>	1
<b>Rack with back and side stop</b>	1	<b>Grill mesh</b>	1
<b>20mm deep tray</b>	1	<b>Telescopic Guide rails, partial Extraction</b>	1

## Electrical Connection

<b>Plug</b>	(I) Australia	<b>Installed electric cable</b>	Yes, Single phase
<b>Electrical connection rating</b>	4000 W	<b>Power supply cable length</b>	120 cm
<b>Current</b>	18 A	<b>Additional connection modalities</b>	Yes, Double and Three Phase
<b>Voltage</b>	220-240 V	<b>Frequency</b>	50/60 Hz
<b>Voltage 2 (V)</b>	380-415 V	<b>Terminal block</b>	3 poles

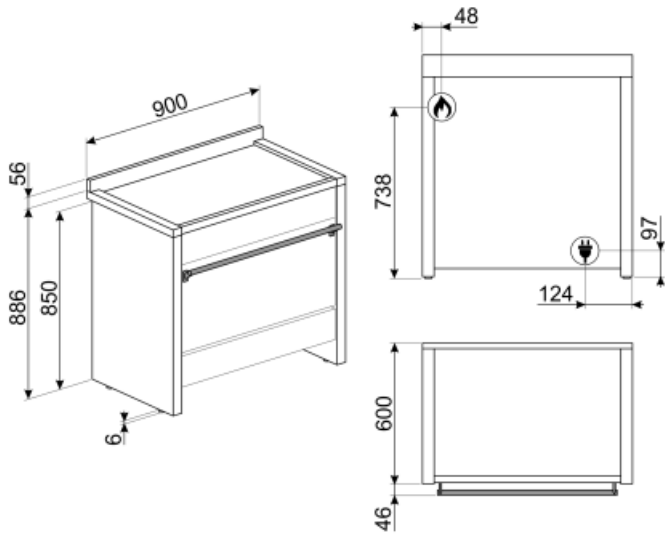

## Not included accessories

### AIRFRY9

Air fryer rack AIRFRY . Ideal for recreating traditional frying in the oven, but with fewer calories and less fat. It allows you to cook quickly and simply dishes such as French fries, fried vegetables and fish, ensuring perfect browning and crispiness.



### KITH95A1X

Height extension kit (950 mm), stainless steel, suitable for Opera A1 cookers



### PRTX

Refractory pizza stone with handles. D=35cm Not suitable for microwave ovens. Suitable for gas ovens, to be put on the griddle.



### PPR9

Refractory pizza stone without handles. Squared shaped stone: L64xH2,3xP37,5 cm Suitable also for gas ovens, to be put on the griddle.



### GRM

Coffee machine support



### TPKX

Stainless steel teppanyaki plate, suitable for A1-9 Opera cooker



### GTT

Totally extractable telescopic guides (1 level), suitable for traditional ovens. Made in stainless steel, they guarantee stability and facilitate the smooth extraction of the trays.



### SFLK1

Child lock



### GTP

Partially extractable telescopic guides (1 level), suitable for traditional ovens. Made in stainless steel, they guarantee stability and facilitate the smooth extraction of the trays.



### KIT1A1PY-9

Splashback, stainless steel, 90cm, suitable for pyrolytic Opera A1-9 cookers



### KIT2A1-9

Plinth, 90 cm, only frontal, stainless steel suitable for A1-9 Opera cooker



### BBQ9



### PALPZ

Pizza shovel with folding handle. Dimensions L31.5 x H32.5 cm. Easy and convenient to use and store. Perfect for serving pizza, bread and savory pastries in a safe and professional way.







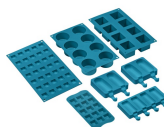























### SMOLD

Set of 7 silicone moulds for ice creams, ice lollies, pralines, ice cubes or to portion food. Usable from -60°C to +230°C



## Symbols glossary (TT)

-  Triple Fan Technology: The oven is equipped with an exclusive three fan system, which, combined with the increased power of the motors, enables excellent cooking performance. The two large side fans distribute the air around the outer perimeter of the cavity while the smaller central fan increases ventilation by creating a vertical vortex of heat. Accordingly, the temperature within the cavity is uniform, allowing food to be cooked evenly on all five levels, like in professional kitchens.
-  Air cooling system: to ensure a safe surface temperatures.
-  Defrost by weight: Automatic defrost function. You choose the type of food to defrost from the available categories (MEAT - FISH - BREAD - DESSERTS) After entering the weight of the food, the oven automatically defines the time required for proper defrosting.
-  Ever Clean Enamel: Ever Clean enamel is applied electrostatically, corner to corner and edge to edge to prevent cracking or cracks over time. It is a particular pyrolytic enamel, resistant to acids which, in addition to being pleasantly bright, promotes greater cleaning of the oven walls, thanks to its lower porosity. It is baked at over 850 ° C and slowly polymerized at a scientifically determined rate to ensure uniform depth and strength Ever Clean enamel creates an impeccable finish both on the inside of the oven and on the trays, making the surfaces of the oven incredibly easy to maintain over time as it reduces the adhesion of fat during cooking
-  Fan assisted base: the mix of fan and lower heating element alone allows to finish cooking foods already cooked on the surface but not internally more quickly. This system is recommended to finish cooking foods that are already well cooked on the surface, but not internally, which therefore require a moderate higher heat. Ideal for any type of food.
-  Static: Traditional cooking suitable for the preparation of one dish at a time. The fan is not active and the heat comes from below and from above at the same time. Static cooking is slower and more delicate, ideal in order to get well cooked and dry dishes even inside. Ideal for cooking all types of roasts, fatty meats, bread, filled cakes.
-  Heavy duty cast iron pan stands: for maximum stability and strength.
-  Defrost by time: Manual defrost function. At the end of the set duration, the function stops.
-  Triple glazed doors: Number of glazed doors.
-  Fingerprint proof stainless steel: Fingerprint proof stainless steel keeps stainless steel looking as good as new.
-  Fan assisted: Intense and homogeneous traditional cooking, also suitable for complex recipes. The fan is active and the heat comes from below and from above at the same time. Ventilated cooking ensures a faster and more homogeneous result, leaving fragrant foods outside and moister inside. Ideal for baked pasta, biscuits, roasts and cobblers.
-  Base: the heat comes only from the bottom of the cavity. The fan is not active. Ideal for sweet and savory pies, cobblers and pizzas. Designed to complete cooking and make food more crunchy This symbol in gas ovens indicates the gas burner.

-  **Circulaire with lower element:** The addition of the lower element adds extra heat at the base for food which requires extra cooking.
-  **Circulaire:** it is the perfect function for cooking all types of dishes in a more delicate way. The heat comes from the back of the oven and is distributed quickly and evenly. The fan is active. It is also ideal for cooking on multiple levels without mixing smells and flavors.
-  **ECO:** low energy consumption cooking: this function is particularly suitable for cooking on a single shelf with low energy consumption. It is recommended for all types of food except those that can generate a lot of moisture (for example vegetables). To achieve maximum energy savings and reduce time, it is recommended to put the food in the oven without preheating the cooking compartment.
-  **Grill:** Very intense heat coming only from above from a double heating element. The fan is not active. Provides excellent grilling and gratinating results. Used at the end of cooking, it gives a uniform browning to dishes.
-  **Half grill:** For rapid cooking and browning of foods. Best results can be obtained by using the top shelf for small items, the lower shelves for larger ones, such as chops or sausages. For half grill heat is generated only at the centre of the element, so is ideal for smaller quantities.
-  **Fan grill:** very intense heat coming only from above from a double heating element. The fan is active. It allows the optimal grilling of thickest meats. Ideal for large cuts of meat.
-  **All glass inner door:** All glass inner door, a single flat surface which is simple to keep clean.
-  **The inner door glass:** can be removed with a few quick movements for cleaning.
-  **Side lights:** Two opposing side lights increase visibility inside the oven.
-  **Automatic opening:** some models have Automatic opening door when the cycle is finished which is a perfect solution for handle-less kitchen units as no handle is needed. For safety reasons, the door locks automatically when the machine is in use to avoid it being opened inadvertently.
-  **PYROLYSIS - AUTOMATIC CLEANING FUNCTION:** the oven heats up to a temperature approaching 500 ° C and chars grease and food residues into a fine ash that can be easily wiped off with a damp cloth. At such a high temperature, the door locks automatically for safety, while the temperature of the door remains controlled so it is safe to touch. User adjustable function based on the level of dirt present in the oven.
-  **Plate rack warming:** function for heating or keeping dishes warm. Place the baking tray on the lowest shelf and stack the dishes to be heated.
-  **Air at 40°C** provides the perfect environment for proving yeast type dough mixes. Simply select the function and place dough in the cavity for allotted.
-  **SABBATH:** function that allows to cook food respecting Judaism's day of rest provisions.
-  **The oven cavity has 5 different cooking levels.**
-  **Soft close:** all models are equipped with advanced function of smooth closing of the door, which allows the device to close smoothly and quietly.



Telescopic rails: allow you to pull out the dish and check it without having to remove it from the oven entirely.



Electronic control: Allows you to maintain temperature inside the oven with the precision 2-3 ° C. This enables to cook meals that are very sensitive to temperature changes, such as cakes, souffles, puddings.



Tilting grill: the tilting grill can be easily unhooked to move the heating element and clean the roof of the appliance in one simple step.



Ultra rapid burners: Powerful ultra rapid burners offer up to 5kw of power.



Vapor Clean: a simple cleaning function using steam to loosen deposits in the oven cavity.



The capacity indicates the amount of usable space in the oven cavity in litres.



With a simple and intuitive interface, the COMPACTscreen provides a pleasant user experience, thanks to the interaction with the knobs.



## Benefit (TT)

---

### **True-convection**

The best cooking performances guaranteed by ventilated circular flow

Multiple fans and heating elements guarantee the perfect aerodynamic heat flow, allowing homogeneous and quicker cooking inside the cavity.

### **Gas hob**

Induction offers fast cooking and precise temperature control

Equipped with a thermocouple, the gas supply is cut off if the flame is extinguished for greater safety.

### **Isothermic Cavity**

The best cooking performance at the highest energy efficiency

### **Triple Turbine**

The oven has three fans and two circular heating elements, allowing cooking with rotating heat

### **Tangential cooling**

New cooling system with tangential fan and airflow from the door to the splashback

### **Soft close**

The door is equipped with a specific system for silent closing

### **Pyrolysis**

Easy oven cleaning thanks to special pyrolytic function

### **LCD display**

Easy and intuitive user-experience and cook with a simple touch

### **Multilevel halogen light**

Internal halogen lighting on different levels guarantees excellent visibility

### **Electronic control**

Electronic control for timely temperature management and heat uniformity

### **Telescopic guides**

Easy extraction and safe insertion of trays into the oven thanks to telescopic guides

### **Adjustable height**

Cooker top flushed with the working area thanks to adjustable feet

### **Sabbath mode**

Possibility of cooking food in compliance with the provisions of the Jewish religious holiday of rest, thanks to Sabbath mode

### **Removable inner glass**

Internal door glasses are easily removable for complete cleaning

### **Multilevel cooking**

Several cooking levels allow maximum flexibility of use

### **Cold door**

During any function, the external door glass is cold, avoiding any risk of burns

### **AirFry (AIRFRY optional accessory)**

Lighter and tastier food thanks to airfry basket (optional accessory)

### **Drawer storage compartment**

More space thanks to the lower drawer compartment, ideal for storing accessories or cooking utensils

### **BBQ (optional accessory)**

Barbeque cooking directly in the oven with the double-sided grill (BBQ optional accessory)

### **Pizza stone (optional accessory)**

Baking with refractory stone for soft and crispy pizza and yeast products (STONE optional accessory)