

A2-81

Cooker size	100x60 cm
N. of cavities with energy label	2
Cavity heat source	ELECTRICITY
Hob type	Gas
Type of main oven	Thermo-ventilated
Type of second oven	Static
Cleaning system main oven	Catalytic
EAN code	8017709256746
Energy efficiency class	A
Energy efficiency class, second cavity	B



Aesthetics



Design	Professional	Type of control setting hob	Control knobs
Command panel finish	Finger friendly stainless steel	Type of control knobs	Smeg Classic
Aesthetic	Classica	Controls colour	Stainless steel
Logo	Assembled st/steel	No. of controls	10
Colour	Stainless steel	Serigraphy colour	Black
Logo position	Facia below the oven	Display name	DigiScreen
Finishing	Satin	Door	With 2 horizontal strips
Upstand	Yes	Glass type	Eclipse
Series	Opera	Handle	Smeg Classic
Hob colour	Stainless steel	Handle Colour	Brushed stainless steel
Type of pan stands	Cast Iron	Storage compartment	Drawer

Programs / Functions main oven

No. of cooking functions 8
 Traditional cooking functions

Static	Fan assisted	Circulaire
Eco	Small grill	Large grill
Fan grill (small)	Fan assisted base	

Cleaning functions

Catalytic



Vapor clean

Programs / Functions auxiliary oven

Cooking functions cavity 2

4

Traditional cooking functions, cavity 2



Static



Small grill



Large grill



Bottom

Hob technical features



Total no. of cook zones 6

Front left - Gas - Semi Rapid - 1.80 kW

Rear left - Gas - 2UR (dual) - 4.20 kW

Front centre - Gas - AUX - 1.00 kW

Rear centre - Gas - Semi Rapid - 1.80 kW

Front right - Gas - 2UR (dual) - 4.20 kW

Rear right - Gas - Rapid - 3.00 kW

Type of gas burners Standard

Gas safety valves Yes

Automatic electronic ignition Yes

Burner caps

Matt black enamelled

Main Oven Technical Features



No. of lights 1

Fan number 1

Net volume of the cavity 61 l

Gross volume, 1st cavity 70 l

Cavity material Ever Clean enamel

No. of shelves 4

Type of shelves Metal racks

Light type Halogen

Light Power 40 W

Cooking time setting Start and Stop

Light when oven door is open Yes

Door opening Flap down

Removable door Yes

Total no. of door glasses 3

No. of thermo-reflective door glasses 2

Safety Thermostat Yes

Cooling system Tangential

Usable cavity space dimensions (HxWxD) 316x460x412 mm

Temperature control Electro-mechanical

Lower heating element power 1200 W

Upper heating element - Power 1000 W

Grill element 1700 W

Large grill - Power 2700 W

Circular heating element - Power 2000 W

Grill type Electric

Tilting grill Yes

Options Main Oven

Timer	Yes	Minimum Temperature	50 °C
End of cooking acoustic alarm	Yes	Maximum temperature	250 °C

Second Oven Technical Features



Net volume of the second cavity	35 l	No. total door glasses	3
Gross volume, 2nd cavity	36 l	No. thermo-reflective door glasses	2
Cavity material	Ever Clean enamel	Safety Thermostat	Yes
No. of shelves	4	Cooling system	Tangential
Type of shelves	Metal racks	Usable cavity space dimensions (HxWxD)	310x255x417 mm
Roof Liner	Yes	Temperature control	Electro-mechanical
No. of lights	1	Lower heating element - power	700 W
Light type	Incandescent	Upper heating element - Power	600 W
Light Power	25 W	Grill element - power	1300 W
Light when oven door is open	Yes	Large grill - Power	2050 W
Door opening	Flap down	Grill type	Electric
Removable door	Yes		

Options Auxiliary Oven

Minimum Temperature	50 °C	Maximum temperature	250 °C
---------------------	-------	---------------------	--------

Accessories included for Main Oven & Hob

Rack with back and side stop	1	Grill mesh	1
20mm deep tray	1	Catalityc panels	3
40mm deep tray	1		

Accessories included for Secondary Oven

Rack with back and side stop	1	Grill mesh	1
Wide baking tray	1		

Electrical Connection

Electrical connection rating	5300 W	Additional connection modalities	Double and Three Phase
Current	23 A	Frequency	50/60 Hz
Voltage	220-240 V	Terminal block	3 poles
Electric cable	Installed, Single phase	Plug	Not present
Power supply cable length	200 cm		

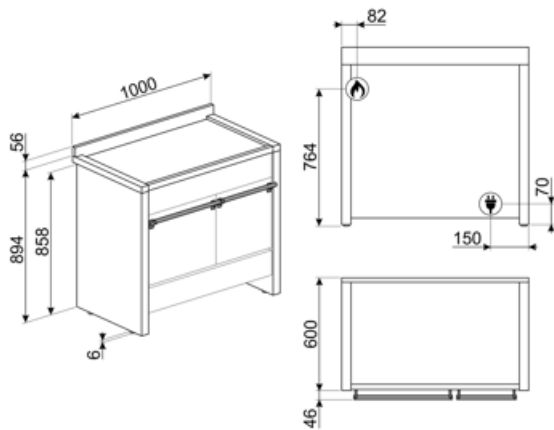

Compatible Accessories

AIRFRY

Air fryer rack AIRFRY. Ideal for recreating traditional frying in the oven, but with fewer calories and less fat. It allows you to cook quickly and simply dishes such as French fries, fried vegetables and fish, ensuring perfect browning and crispiness.



BBQ

Double sided plate BBQ. Suitable for recreating succulent and crispy dishes in the oven with the typical taste of grilled cooking. The ribbed side is particularly suitable for meats and cheeses. The smooth side for fish, seafood and vegetables.



BN640

Enamelled tray suitable for 45cm and 60cm ovens. Depth 540 mm. Perfect for cooking and roasting meat and fish in sauces. Also ideal for experimenting with lighter and crunchy side dishes



GRM

Coffee machine support



GTT

Totally extractable telescopic guides (1 level), suitable for traditional ovens. Made in stainless steel, they guarantee stability and facilitate the smooth extraction of the trays.



KIT2A2-8

Plinth, 100 cm, only frontal, stainless steel, suitable for A2 Opera cookers



PALPZ

Pizza shovel with folding handle. Dimensions L31.5 x H32.5 cm. Easy and convenient to use and store. Perfect for serving pizza, bread and savory pastries in a safe and professional way.



SMOLD

Set of 7 silicone moulds for ice creams, ice lollies, pralines, ice cubes or to portion food. Usable from -60°C to +230°C

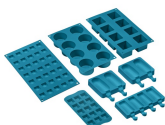

AIRFRY2

Air fryer tray. Ideal for recreating traditional frying in the oven, but with fewer calories and less fat. It allows you to cook quickly and simply dishes such as French fries, fried vegetables and fish, ensuring perfect browning and crispiness.



BN620-1

Enamelled tray suitable for 45 cm and 60 cm ovens. Depth 20 mm. Perfect for a wide range of savoury and sweet baking.



BNP608T

Teflon-coated tray, 8 mm depth, to be placed on the grid



GTP

Partially extractable telescopic guides (1 level), suitable for traditional ovens. Made in stainless steel, they guarantee stability and facilitate the smooth extraction of the trays.



KIT1A2PY-81

Splashback stainless steel, 100cm, suitable for Opera A2 cookers with MF and pyro oven



KIT3-6

Height extension kit 2 lateral sides (950mm), stainless steel, for Opera cookers A2,A3,A4 (945-965mm)

















SFLK1



Child lock







Symbols glossary



 <p>Heavy duty cast iron pan stands: for maximum stability and strength.</p>	 <p>Catalytic cleaning: the system ensures perfect hygiene inside the oven thanks to the three self-cleaning panels coated with a special enamel that promotes the progressive elimination of traces of grease and odors caused by cooking.</p>
 <p>Energy efficiency class A</p>	 <p>Installation in column: Installation in column.</p>
 <p>B: Product energy rating, measured from A+++ to D / G depending on the product family.</p>	 <p>Air cooling system: to ensure a safe surface temperatures.</p>
 <p>Triple glazed doors: Number of glazed doors.</p>	 <p>Ever Clean Enamel: Ever Clean enamel is applied electrostatically, corner to corner and edge to edge to prevent cracking or cracks over time. It is a particular pyrolytic enamel, resistant to acids which, in addition to being pleasantly bright, promotes greater cleaning of the oven walls, thanks to its lower porosity. It is baked at over 850 °C and slowly polymerized at a scientifically determined rate to ensure uniform depth and strength. Ever Clean enamel creates an impeccable finish both on the inside of the oven and on the trays, making the surfaces of the oven incredibly easy to maintain over time as it reduces the adhesion of fat during cooking.</p>
 <p>Fingerprint proof stainless steel: Fingerprint proof stainless steel keeps stainless steel looking as good as new.</p>	 <p>Fan assisted base: the mix of fan and lower heating element alone allows to finish cooking foods already cooked on the surface but not internally more quickly. This system is recommended to finish cooking foods that are already well cooked on the surface, but not internally, which therefore require a moderate higher heat. Ideal for any type of food.</p>
 <p>Fan assisted: Intense and homogeneous traditional cooking, also suitable for complex recipes. The fan is active and the heat comes from below and from above at the same time. Ventilated cooking ensures a faster and more homogeneous result, leaving fragrant foods outside and moister inside. Ideal for baked pasta, biscuits, roasts and cobbles.</p>	 <p>Static: Traditional cooking suitable for the preparation of one dish at a time. The fan is not active and the heat comes from below and from above at the same time. Static cooking is slower and more delicate, ideal in order to get well cooked and dry dishes even inside. Ideal for cooking all types of roasts, fatty meats, bread, filled cakes.</p>
 <p>Base: the heat comes only from the bottom of the cavity. The fan is not active. Ideal for sweet and savory pies, cobbles and pizzas. Designed to complete cooking and make food more crunchy. This symbol in gas ovens indicates the gas burner.</p>	 <p>Circulaire: it is the perfect function for cooking all types of dishes in a more delicate way. The heat comes from the back of the oven and is distributed quickly and evenly. The fan is active. It is also ideal for cooking on multiple levels without mixing smells and flavors.</p>



-  **ECO:** low energy consumption cooking: this function is particularly suitable for cooking on a single shelf with low energy consumption. It is recommended for all types of food except those that can generate a lot of moisture (for example vegetables). To achieve maximum energy savings and reduce time, it is recommended to put the food in the oven without preheating the cooking compartment.



 **Fan with grill element:** The fan reduces the fierce heat from the grill, providing an excellent method of grilling various foods, chops, steaks, sausages etc. giving even browning and heat distribution, without drying out the food. The top two levels recommended for use, and the lower part of the oven can be used to keep items warm at the same time, an excellent facility when cooking a grilled breakfast. Half grill (centre portion only) is ideal for small quantities of food.
-  **Grill:** Very intense heat coming only from above from a double heating element. The fan is not active. Provides excellent grilling and gratinating results. Used at the end of cooking, it gives a uniform browning to dishes.



 **Half grill:** For rapid cooking and browning of foods. Best results can be obtained by using the top shelf for small items, the lower shelves for larger ones, such as chops or sausages. For half grill heat is generated only at the centre of the element, so is ideal for smaller quantities.
-  **Side lights:** Two opposing side lights increase visibility inside the oven.

 **Automatic opening:** some models have Automatic opening door when the cycle is finished which is a perfect solution for handle-less kitchen units as no handle is needed. For safety reasons, the door locks automatically when the machine is in use to avoid it being opened inadvertently.
-  **Removable roof liner:** This is a perfect solution that protects the upper part of the cavity of the oven from pollution. Easy to remove for cleaning, it can be washed in the dishwasher.

 **The oven cavity has 4 different cooking levels.**
-  **Electronic control:** Allows you to maintain temperature inside the oven with the precision 2-3 ° C. This enables to cook meals that are very sensitive to temperature changes, such as cakes, souffles, puddings.

 **Tilting grill:** the tilting grill can be easily unhooked to move the heating element and clean the roof of the appliance in one simple step.
-  **Ultra rapid burners:** Powerful ultra rapid burners offer up to 5kw of power.

 **Vapor Clean:** a simple cleaning function using steam to loosen deposits in the oven cavity.
-  **The capacity indicates the amount of usable space in the oven cavity in litres.**

 **The capacity indicates the amount of usable space in the oven cavity in litres.**
-  **4.3 inch display with LED technology, usability with knobs + 3 touch keys**

 **Knobs control**

Benefit (TT)

Gas hob

Gas provides permanent control of the heat source and the temperature change is immediate

Equipped with a thermocouple, the gas supply is cut off if the flame is extinguished for greater safety.

Catalysis

Easy oven cleaning through the use of catalytic panels in the cavity

This permanent process allows continuous cleaning and degreasing of the three cavity walls, starting its grease oxidation phase when the oven reaches 200 °C.

Touch control

Easy and intuitive timer setting with a single touch

Drawer storage compartment

More space thanks to the lower drawer compartment, ideal for storing accessories or cooking utensils

True-convection

The best cooking performances guaranteed by ventilated circular flow

Multiple fans and heating elements guarantee the perfect aerodynamic heat flow, allowing homogeneous and quicker cooking inside the cavity.

Multilevel cooking

Several cooking levels allow maximum flexibility of use

Multilevel halogen light

Internal halogen lighting on different levels guarantees excellent visibility

Tangential cooling

New cooling system with tangential fan and airflow from the door to the splashback

Adjustable height

Cooker top flushed with the working area thanks to adjustable feet

Isothermic Cavity

The best cooking performance at the highest energy efficiency

AirFry (AIRFRY optional accessory)

Lighter and tastier food thanks to airfry basket (optional accessory)

Cold door

During any function, the external door glass is cold, avoiding any risk of burns

Pizza stone (optional accessory)

Baking with refractory stone for soft and crispy pizza and yeast products (STONE optional accessory)

BBQ (optional accessory)

Barbecue cooking directly in the oven with the double-sided grill (BBQ optional accessory)

Single turbine

The oven has a fan equipped with a circular heating element allowing cooking with rotating heat