

A2PYID-81

Cooker size	100x60 cm
N. of cavities with energy label	2
Cavity heat source	Electric
Hob type	Induction
Type of main oven	Thermo-ventilated
Type of second oven	Static
Cleaning system main oven	Pyrolytic
EAN code	8017709256777
Energy efficiency class	A
Energy efficiency class, second cavity	A



Aesthetics











Design	Professional	Control knobs	Smeg Classic
Command panel finish	Stainless steel	Controls colour	Stainless steel
Aesthetics	Classic	No. of controls	9
Logo	Assembled st/steel	Serigraphy colour	Black
Colour	Stainless steel	Display	Touch
Logo position	Facia below the oven	Door	With 2 horizontal strips
Finishing	Brushed	Glass type	dark grey
Upstand	Yes	Handle	Smeg Classic
Series	Opera	Handle Colour	Brushed stainless steel
Hob colour	Stainless steel	Storage compartment	Drawer
Type of control setting	Control knobs		

Programs / Functions

No. of cooking functions	9
--------------------------	---

Traditional cooking functions

-  Static
-  Fan assisted
-  Circulaire
-  Turbo (circulaire + bottom + upper + fan)
-  ECO
-  Large grill
-  Fan grill (small)
-  Fan assisted base

Cleaning functions

-  Pyrolytic

Programs / Functions Auxiliary Oven

Cooking functions cavity 2 6

Traditional cooking functions, cavity 2

-  Static
-  Small grill
-  Large grill
-  Bottom
-  Rotisserie + grill
-  Roof

Hob technical features



Total no. of cook zones 5

- Front left - Induction - single - 1.40 kW - Booster 2.20 kW - Ø 14.5 cm
- Rear left - Induction - single - 1.85 kW - Booster 3.00 kW - Ø 18.0 cm
- Central - Induction - single - 2.60 kW - Booster 3.70 kW - Ø 27.0 cm
- Rear right - Induction - single - 2.30 kW - Booster 3.70 kW - Ø 21.0 cm
- Front right - Induction - single - 1.40 kW - Booster 2.20 kW - Ø 14.5 cm

No. of cooking zones with Booster	5	Minimum pan diameter indication	Yes
Automatic switch off when overheat	Yes	Selected zone indicator	Yes
Automatic pan detection	Yes	Residual heat indicator	Yes

Main Oven Technical Features



No. of lights 1 No. of thermo-reflective door glasses 3

Fan number	1	Safety Thermostat	Yes
Net volume of the cavity	61 litres	Cooling system	Tangential
Gross volume, 1st cavity	68 l	Door Lock During Pyrolysis	Yes
Cavity material	Easy clean enamel	Usable cavity space dimensions (HxWxD)	316x460x412 mm
Shelf positions	4	Temperature control	Electro-mechanical
Type of shelves	Metal racks	Lower heating element power	1200 W
Light type	Halogen	Upper heating element - Power	1000 W
Light power	40 W	Grill element	1700 W
Cooking time setting	Start and Stop	Large grill - Power	2700 W
Light when oven door is open	Yes	Circular heating element - Power	2000 W
Door opening	Flap down	Grill type	Electric
Removable door	Yes	Tilting grill	Yes
Total no. of door glasses	4		

Options Main Oven

Timer	Yes	Minimum Temperature	50 °C
End of cooking acoustic alarm	Yes	Maximum temperature	280 °C

Second Oven Technical Features



Net volume of the second cavity	35 litres	No. total door glasses	3
Gross volume, 2nd cavity	39 l	No. thermo-reflective door glasses	2
Cavity material	Easy clean enamel	Safety Thermostat	Yes
Shelf positions	4	Cooling system	Tangential
Type of shelves	Metal racks	Usable cavity space dimensions (HxWxD)	310x255x417 mm
Roof Liner	Yes	Temperature control	Electro-mechanical
No. of lights	1	Lower heating element - power	750 W
Light type	Incandescent	Upper heating element - Power	600 W
Light power	25 W	Grill element - power	1300 W
Light when oven door is open	Yes	Large grill - Power	2050 W
Door opening	Flap down	Grill type	Electric
Removable door	Yes		

Options Auxiliary Oven

Minimum Temperature	50 °C	Maximum temperature	250 °C
----------------------------	-------	----------------------------	--------

Accessories included for Main Oven & Hob

Chrome shelf with back and side stop	1	40mm deep tray	1
20mm deep tray	1	Grill mesh	1

Accessories included for Secondary Oven

Chrome shelf with back and side stop	1	Grill mesh	1
Wide baking tray	1		

Electrical Connection

Max Power Draw	12500 W	Power supply cable length	200 cm
Current	37 A	Frequency	50/60 Hz
Voltage	220-240 V	Terminal block	3 poles
Voltage 2 (V)	380-415 V	Plug	No

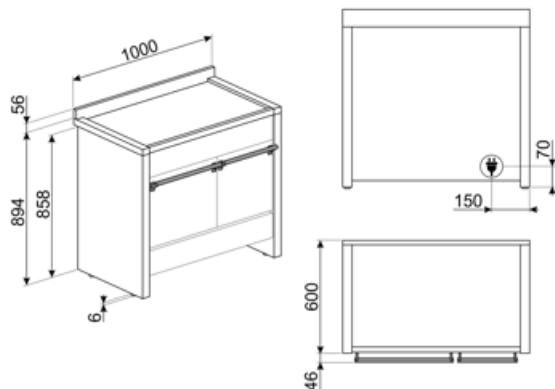

Compatible Accessories

AIRFRY

Air fryer rack AIRFRY. Ideal for recreating traditional frying in the oven, but with fewer calories and less fat. It allows you to cook quickly and simply dishes such as French fries, fried vegetables and fish, ensuring perfect browning and crispiness.



BBQ

Double sided plate BBQ. Suitable for recreating succulent and crispy dishes in the oven with the typical taste of grilled cooking. The ribbed side is particularly suitable for meats and cheeses. The smooth side for fish, seafood and vegetables.



BN640

Enamelled tray, 40mm deep



GRILLPLATE

Universal griddle for induction, gas, ceramic and electric hobs. Non-stick surface ideal for cooking meat, cheese and vegetables. Dimensions: 410 x 240 mm.



GTT

Totally extractable telescopic guides (1 level) Extraction: 433 mm Material: Stainless steel AISI 430 polished



KIT3-6

Height extension kit (950 mm), stainless steel, for Opera cookers



SCRP

Induction and ceramic hobs and teppanyaki scraper



SMOLD

Set of 7 silicone moulds for ice creams, ice lollies, pralines, ice cubes or to portion food. Usable from -60°C to +230°C

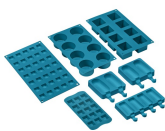

AIRFRY2

Air fryer tray. Ideal for recreating traditional frying in the oven, but with fewer calories and less fat. It allows you to cook quickly and simply dishes such as French fries, fried vegetables and fish, ensuring perfect browning and crispiness.



BN620-1

Enamelled tray, 20mm deep



BNP608T

Teflon-coated tray, 8mm depth, to be placed on the grid



GTP

Partially extractable telescopic guides (1 level) Extraction: 300 mm Material: Stainless steel AISI 430 polished



KIT2A2-8

Plinth, 100 cm, stainless steel suitable for A2-8 Opera cookers



PALPZ

Pizza shovel with fold away handle width: 315mm length : 325mm



SFLK1

Child lock



































TPKPLATE

Universal plate for induction, gas, ceramic and electric hobs. Non-stick surface ideal for cooking fish, eggs and vegetables. Dimensions: 410 X 240 mm.



Symbols glossary

 <p>A: Product drying performance, measured from A+++ to D / G depending on the product family</p>	 <p>Power booster: option allows the zone to work at full power when very intense cooking is necessary.</p>
 <p>Installation in column: Installation in column</p>	 <p>Air cooling system: to ensure a safe surface temperatures.</p>
 <p>Triple glazed doors: Number of glazed doors.</p>	 <p>Quadruple glazed: Number of glazed doors.</p>
 <p>Enamel interior: The enamel interior of all Smeg ovens have a special antacid lining which helps keep the interior clean by reducing the amount of cooking grease adhering to it.</p>	 <p>Fan assisted base: the mix of fan and lower heating element alone allows to finish cooking foods already cooked on the surface but not internally more quickly. This system is recommended to finish cooking foods that are already well cooked on the surface, but not internally, which therefore require a moderate higher heat. Ideal for any type of food.</p>
 <p>Fan with upper and lower elements: The elements combined with the fan aim to provide more uniform heat, a similar method to conventional cooking, so pre-heat is required. Most suitable for items requiring slow cooking methods.</p>	 <p>Upper and lower element only: a traditional cooking method best suited for single items located in the centre of the oven. the top pf the oven will always be hottest. Ideal for roast, fruit cakes, bread etc.</p>
 <p>Lower heating element only: This function is ideal for foods that require extra base temperature without browning, e.g. pastry dishes, pizza. Also suitable for slow cooking of stews and casseroles.</p>	 <p>Circulaire: The combination of the fan and circular element around it gives a hot air cooking method. This provides many benefits including no preheat if cook time is more than 20 minutes, no flavour transfer when cooking different foods at the same time, less energy, and shorter cook times. Good for all types of food.</p>
 <p>ECO: The combination of the grill, fan and lower element is particularly suitable for cooking small quantities of food.</p>	 <p>Fan with grill element: The fan reduces the fierce heat from the grill, providing an excellent method of grilling various foods, chops, steaks, sausages etc. giving even browning and heat distribution, without drying out the food. The top two levels recommended for use, and the lower part of the oven can be used to keep items warm at the same time, an excellent facility when cooking a grilled breakfast. Half grill (centre portion only) is ideal for small quantities of food.</p>
 <p>Grill element: Using of grill gives excellent results when cooking meat of medium and small portions, especially when combined with a rotisserie (where possible). Also ideal for cooking sausages and bacon.</p>	 <p>Half grill: For rapid cooking and browning of foods. Best results can be obtained by using the top shelf for small items, the lower shelves for larger ones, such as chops or sausages. For half grill heat is generated only at the centre of the element, so is ideal for smaller quantities.</p>

-  Rotisserie with half grill: These symbols allow use of the rotisserie with half grill.
-  Top element only: This is used from above only, and is ideal for foods that are finished off with golden topping but do not require the full heat from the grill. Dishes such as Lasagne, potato topped foods, and cheese topped recipes benefit from this mode.
-  Induction: The work of these hobs is based on the principle of electromagnetic induction. The heat is generated directly in the bottom of the pan during its contact with the hob.
-  Automatic opening: some models have Automatic opening door when the cycle is finished which is a perfect solution for handle-less kitchen units as no handle is needed. For safety reasons, the door locks automatically when the machine is in use to avoid it being opened inadvertently.
-  Indication of residual heat: After the glass ceramic hob is switched off the residual heat indicator shows which of the heating zones still remains hot. When the temperature drops below 60 ° C, the indicator goes out.
-  The oven cavity has 4 different cooking levels.
-  Tilting grill: the tilting grill can be easily unhooked to move the heating element and clean the roof of the appliance in one simple step.
-  The capacity indicates the amount of usable space in the oven cavity in litres.
-  Knobs control
-  Circulaire with upper and lower elements: The use of the fan with both elements allows food to be cooked quickly and effectively, ideal for large joints that require thorough cooking. It offers a similar result to rotisserie, moving the heat around the food, instead of moving the food itself, enabling any size or shape to be cooked.
-  Overheat protection: The safety system that automatically turns off the hob in case of overheating of the control unit.
-  Side lights: Two opposing side lights increase visibility inside the oven.
-  Pyrolytic: Pyrolytic cleaning cycles can be selected as necessary to automatically clean the oven interior.
-  Removable roof liner: This is a perfect solution that protects the upper part of the cavity of the oven from pollution. Easy to remove for cleaning, it can be washed in the dishwasher.
-  Electronic control: Allows you to maintain temperature inside the oven with the precision 2-3 ° C. This enables to cook meals that are very sensitive to temperature changes, such as cakes, souffles, puddings.
-  The capacity indicates the amount of usable space in the oven cavity in litres.
-  The touch timer display or DigiScreen guarantees simple functionality. They display the time, set programmed cooking and the minute minder timer.

Benefit

Induction hob

Induction offers fast cooking and precise temperature control

Through the use of suitable cookware, induction is easy to use and maintain, safe and responsive

Pyrolysis

Easy oven cleaning thanks to special pyrolytic function

Touch control

Easy and intuitive timer setting with a single touch

Drawer storage compartment

More space thanks to the lower compartment, ideal for storing accessories or cooking utensils

Circulaire

The best cooking performances guaranteed by ventilated circular flow.

Multiple fans and heating elements guarantee the perfect aerodynamic heat flow, allowing homogeneous and quicker cooking inside the cavity.

Multilevel cooking

Several cooking levels allow maximum flexibility of use

Multilevel halogen light

Internal halogen lighting on different levels guarantees excellent visibility

Tangential cooling

New cooling system with tangential fan and airflow from the door to the splashback

Adjustable height

Cooker top flushed with the working area thanks to adjustable feet

Isothermic Cavity

The best cooking performance at the highest energy efficiency

AirFry (AIRFRY optional accessory)

Lighter and tastier food thanks to airfry basket

Cold door

During any function, the external door glass is cold, avoiding any risk of burns

Pizza stone (optional accessory)

Baking with refractory stone for soft and crispy pizza and yeast products (STONE optional accessory)

BBQ (optional accessory)

Barbeque cooking directly in the oven with the double-sided grill

Single turbine

The oven has a fan equipped with a circular heating element allowing cooking with rotating heat