

# A5-81

Cooker size	150x60 cm
N. of cavities with energy label	2
Cavity heat source	ELECTRICITY
Hob type	Gas
Type of main oven	Thermo-ventilated
Type of second oven	Thermo-ventilated
Cleaning system main oven	Ever Clean enamel
EAN code	8017709260774
Energy efficiency class	A
Energy efficiency class, second cavity	A











## Aesthetics



<b>Design</b>	Professional	<b>Type of control setting hob</b>	Control knobs
<b>Command panel finish</b>	Finger friendly stainless steel	<b>Type of control knobs</b>	Smeg Classic
<b>Aesthetic</b>	Classica	<b>Controls colour</b>	Stainless steel
<b>Logo</b>	Assembled st/steel	<b>No. of controls</b>	13
<b>Colour</b>	Stainless steel	<b>Serigraphy colour</b>	Black
<b>Logo position</b>	Facia below the oven	<b>Display name</b>	DigiScreen
<b>Finishing</b>	Satin	<b>Door</b>	With 2 horizontal strips
<b>Upstand</b>	Yes	<b>Glass type</b>	Eclipse
<b>Series</b>	Opera	<b>Handle</b>	Smeg Classic
<b>Hob colour</b>	Stainless steel	<b>Handle Colour</b>	Brushed stainless steel
<b>Type of pan stands</b>	Cast Iron	<b>Storage compartment</b>	Drawer

## Programs / Functions main oven









No. of cooking functions 8  
 Traditional cooking functions

 Static	 Fan assisted	 Circulaire
 Turbo	 Eco	 Large grill
 Fan grill (large)	 Fan assisted base	

## Programs / Functions auxiliary oven

Cooking functions cavity 2 8

Traditional cooking functions, cavity 2

 Static	 Fan assisted	 Circulaire
 Large grill	 Fan grill (large)	 Fan-assisted bottom
 Circulaire + bottom	 Pizza	

Cleaning functions cavity 2

Catalisi

## Hob technical features



Total no. of cook zones 7

Front left - Gas - 2UR (dual) - 4.20 kW

Rear left - Gas - Semi Rapid - 1.80 kW

Front centre - Gas - AUX - 1.00 kW

Rear centre - Gas - Rapid - 3.00 kW

Front right - Gas - AUX - 1.00 kW

Rear right - Gas - Fish burner - 1.90 kW

Right - Gas - 2UR (dual) - 5.00 kW

Central - BBQ - 1.60 (BBQ) kW

Type of gas burners Standard

Burner caps Matt black enamelled

Automatic electronic ignition Yes

Automatic switch off when overflow Yes

Gas safety valves Yes

## Main Oven Technical Features



No. of lights	2	Full glass inner door	Yes
Fan number	1	Removable inner door	Yes
Net volume of the cavity	77 l	Total no. of door glasses	3
Gross volume, 1st cavity	90 l	No. of thermo-reflective door glasses	2
Cavity material	Ever Clean enamel	Safety Thermostat	Yes
No. of shelves	4	Cooling system	Tangential
Type of shelves	Metal racks	Usable cavity space dimensions (HxWxD)	305X613X405 mm
Roof Liner	Yes	Temperature control	Electro-mechanical
Light type	Incandescent	Lower heating element power	1750 W
Light Power	25 W	Upper heating element - Power	1050 W
Cooking time setting	Start and Stop		
Light when oven door is open	Yes		
Door opening	Flap down		

Removable door	Yes	Grill element	2800 W
		Circular heating element - Power	2500 W
		Grill type	Electric

## Options Main Oven

Timer	Yes	Minimum Temperature	50 °C
End of cooking acoustic alarm	Yes	Maximum temperature	250 °C

## Second Oven Technical Features

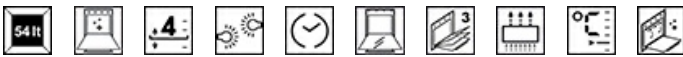

Net volume of the second cavity	54 l	Removable inner door	Yes
Gross volume, 2nd cavity	70 l	No. total door glasses	3
Cavity material	Ever Clean enamel	No. thermo-reflective door glasses	2
No. of shelves	4	Safety Thermostat	Yes
Type of shelves	Metal racks	Cooling system	Tangential
No. of lights	1	Usable cavity space dimensions (HxWxD)	290x444x425 mm
Light type	Halogen	Temperature control	Electro-mechanical
Light Power	40 W	Lower heating element - power	1100 W
Cooking time setting	Stop	Upper heating element - Power	1000 W
Light when oven door is open	Yes	Grill element - power	1700 W
Door opening	Flap down	Circular heating element - Power	2000 W
Removable door	Yes	Grill type	Electric
Full glass inner door	Yes	Tilting grill	Yes

## Options Auxiliary Oven

Timer	Yes	Minimum Temperature	50 °C
End of cooking acoustic alarm	Yes	Maximum temperature	280 °C

## Accessories included for Main Oven & Hob

TOP Oven grid with back stop	2	Wide baking tray	2
------------------------------	---	------------------	---

## Accessories included for Secondary Oven

Rack with back and side stop	1	Catalytic panels	3
------------------------------	---	------------------	---

40mm deep tray	1	<b>Pizza Accessories</b>	Refractory stone + cover + shovel
Grill mesh	1		

## Electrical Connection

Electrical connection rating	7700 W	<b>Power supply cable length</b>	150 cm
Current	34 A	<b>Frequency</b>	50/60 Hz
Voltage	220-240 V	<b>Terminal block</b>	5 poles
Voltage 2 (V)	380-415 V	<b>Plug</b>	Not present
Electric cable	Installed - Double and Three-phase		

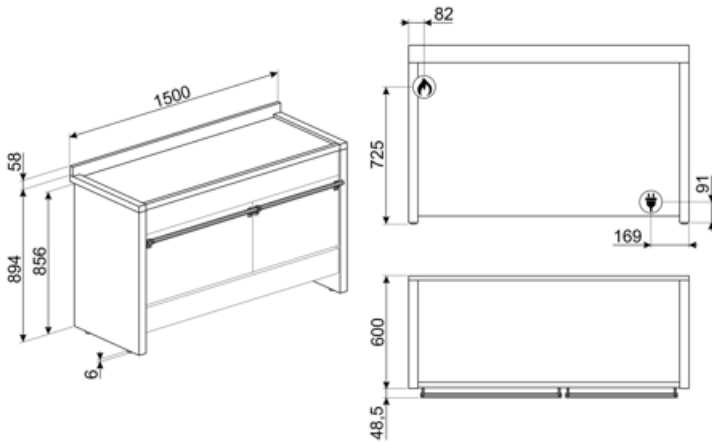

---

## Compatible Accessories

---



### BN620-1

Enamelled tray suitable for 45 cm and 60 cm ovens. Depth 20 mm. Perfect for a wide range of savoury and sweet baking.



### BNP608T

Teflon-coated tray, 8 mm depth, to be placed on the grid



### PALPZ

Pizza shovel with folding handle. Dimensions L31.5 x H32.5 cm. Easy and convenient to use and store. Perfect for serving pizza, bread and savory pastries in a safe and professional way.

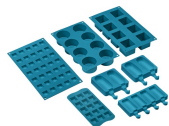

### SMOLD

Set of 7 silicone moulds for ice creams, ice lollies, pralines, ice cubes or to portion food. Usable from -60°C to +230°C



### BN640

Enamelled tray suitable for 45cm and 60cm ovens. Depth 540 mm. Perfect for cooking and roasting meat and fish in sauces. Also ideal for experimenting with lighter and crunchy side dishes



### GRM















Coffee machine support





















### SFLK1

Child lock

## Symbols glossary

 <p>Heavy duty cast iron pan stands: for maximum stability and strength.</p>	 <p>Energy efficiency class A</p>
 <p>Installation in column: Installation in column.</p>	 <p>Air cooling system: to ensure a safe surface temperatures.</p>
 <p>Triple glazed doors: Number of glazed doors.</p>	 <p>Ever Clean Enamel: Ever Clean enamel is applied electrostatically, corner to corner and edge to edge to prevent cracking or cracks over time. It is a particular pyrolytic enamel, resistant to acids which, in addition to being pleasantly bright, promotes greater cleaning of the oven walls, thanks to its lower porosity. It is baked at over 850 °C and slowly polymerized at a scientifically determined rate to ensure uniform depth and strength. Ever Clean enamel creates an impeccable finish both on the inside of the oven and on the trays, making the surfaces of the oven incredibly easy to maintain over time as it reduces the adhesion of fat during cooking.</p>
 <p>Fingerprint proof stainless steel: Fingerprint proof stainless steel keeps stainless steel looking as good as new.</p>	 <p>Fan assisted base: the mix of fan and lower heating element alone allows to finish cooking foods already cooked on the surface but not internally more quickly. This system is recommended to finish cooking foods that are already well cooked on the surface, but not internally, which therefore require a moderate higher heat. Ideal for any type of food.</p>
 <p>Fan assisted: Intense and homogeneous traditional cooking, also suitable for complex recipes. The fan is active and the heat comes from below and from above at the same time. Ventilated cooking ensures a faster and more homogeneous result, leaving fragrant foods outside and moister inside. Ideal for baked pasta, biscuits, roasts and cobblers.</p>	 <p>Static: Traditional cooking suitable for the preparation of one dish at a time. The fan is not active and the heat comes from below and from above at the same time. Static cooking is slower and more delicate, ideal in order to get well cooked and dry dishes even inside. Ideal for cooking all types of roasts, fatty meats, bread, filled cakes.</p>
 <p>Circulaire with lower element: The addition of the lower element adds extra heat at the base for food which requires extra cooking.</p>	 <p>Circulaire: it is the perfect function for cooking all types of dishes in a more delicate way. The heat comes from the back of the oven and is distributed quickly and evenly. The fan is active. It is also ideal for cooking on multiple levels without mixing smells and flavors.</p>
 <p>ECO: low energy consumption cooking: this function is particularly suitable for cooking on a single shelf with low energy consumption. It is recommended for all types of food except those that can generate a lot of moisture (for example vegetables). To achieve maximum energy savings and reduce time, it is recommended to put the food in the oven without preheating the cooking compartment.</p>	 <p>Grill: Very intense heat coming only from above from a double heating element. The fan is not active. Provides excellent grilling and gratinating results. Used at the end of cooking, it gives a uniform browning to dishes.</p>

- |   |   |
|---|---|
|  <p>Fan grill: very intense heat coming only from above from a double heating element. The fan is active. It allows the optimal grilling of thickest meats. Ideal for large cuts of meat.</p>   |  <p>Pizza function: Specific function for cooking pizza in a pan. It allows to obtain a pizza that is soft inside and crispy outside with the topping perfectly cooked, not dry and not burnt.</p> |
|  <p>Turbo: the heat comes from 3 directions: above, below and from the back of the oven. The fan is active. It allows quick cooking, even on several shelves without mixing the aromas. Ideal for large volumes or foods that require intense cooking.</p>  |  <p>All glass inner door: All glass inner door, a single flat surface which is simple to keep clean.</p>   |
|  <p>The inner door glass: can be removed with a few quick movements for cleaning.</p>   |  <p>Side lights: Two opposing side lights increase visibility inside the oven.</p>   |
|  <p>Automatic opening: some models have Automatic opening door when the cycle is finished which is a perfect solution for handle-less kitchen units as no handle is needed. For safety reasons, the door locks automatically when the machine is in use to avoid it being opened inadvertently.</p> |  <p>Overfill protection: The special overfill protection shuts down the stove in the presence of overflow of liquids.</p>  |
|  <p>Removable roof liner: This is a perfect solution that protects the upper part of the cavity of the oven from pollution. Easy to remove for cleaning, it can be washed in the dishwasher.</p>  |  <p>The oven cavity has 4 different cooking levels.</p>  |
|  <p>Electronic control: Allows you to maintain temperature inside the oven with the precision 2-3 ° C. This enables to cook meals that are very sensitive to temperature changes, such as cakes, souffles, puddings.</p>  |  <p>Tilting grill: the tilting grill can be easily unhooked to move the heating element and clean the roof of the appliance in one simple step.</p>  |
|  <p>Timer: All ceramic hobs have a timer which automatically ends cooking after a preset time.</p>  |  <p>Ultra rapid burners: Powerful ultra rapid burners offer up to 5kw of power.</p>  |
|  <p>The capacity indicates the amount of usable space in the oven cavity in litres.</p>   |  <p>The capacity indicates the amount of usable space in the oven cavity in litres.</p>  |
|  <p>4.3 inch display with LED technology, usability with knobs + 3 touch keys</p>   |  <p>Knobs control</p>  |

## Benefit (TT)

---

### **Gas hob**

Gas provides permanent control of the heat source and the temperature change is immediate  
Equipped with a thermocouple, the gas supply is cut off if the flame is extinguished for greater safety.

### **Ever Clean Enamel**

Easy oven cleaning thanks to special pyrolytic enamel

### **Touch control**

Easy and intuitive timer setting with a single touch

### **Drawer storage compartment**

More space thanks to the lower drawer compartment, ideal for storing accessories or cooking utensils

### **True-convection**

The best cooking performances guaranteed by ventilated circular flow  
Multiple fans and heating elements guarantee the perfect aerodynamic heat flow, allowing homogeneous and quicker cooking inside the cavity.

### **Multilevel cooking**

Several cooking levels allow maximum flexibility of use

### **Removable inner glass**

Internal door glasses are easily removable for complete cleaning

### **Tangential cooling**

New cooling system with tangential fan and airflow from the door to the splashback

### **Adjustable height**

Cooker top flushed with the working area thanks to adjustable feet

### **Isothermic Cavity**

The best cooking performance at the highest energy efficiency

### **AirFry (AIRFRY optional accessory)**

Lighter and tastier food thanks to airfry basket (optional accessory)

### **Cold door**

During any function, the external door glass is cold, avoiding any risk of burns

---

**Pizza stone (optional accessory)**

Baking with refractory stone for soft and crispy pizza and yeast products (STONE optional accessory)

**BBQ (optional accessory)**

Barbecue cooking directly in the oven with the double-sided grill (BBQ optional accessory)

**Single turbine**

The oven has a fan equipped with a circular heating element allowing cooking with rotating heat