

## B61GMXI9

Cooker size	60x60 cm
N.º de cavidades com rótulo energético	1
Fonte de calor da cavidade	ELECTRICITY
Hob type	Gas
Tipo de forno principal	Thermo-ventilated
Sistema de limpeza no forno principal	Vapor Clean
EAN code	8017709276362
Energy efficiency class	A



## Aesthetics











<b>Aesthetic</b>	Mista	<b>Control knobs</b>	Smeg USA
<b>Serie</b>	Mestre	<b>Controls colour</b>	Soft touch black
<b>Design</b>	Square design	<b>No. of controls</b>	7
<b>Colour</b>	Stainless steel	<b>Cor da serigrafia</b>	Serigrafia em preto
<b>Acabamento</b>	Satin	<b>Door</b>	With 2 horizontal strips
<b>Command panel finish</b>	Finger friendly stainless steel	<b>Glass type</b>	Black
<b>Logo</b>	Logotipo aplicado	<b>Handle</b>	Smeg Classic
<b>Posição do logotipo</b>	Logotipo no painel abaixo do forno	<b>Handle Colour</b>	Brushed stainless steel
<b>Upstand</b>	Yes	<b>Storage compartment</b>	Door
<b>Cor da placa</b>	Stainless steel	<b>Sliding compartment</b>	No
<b>Type of pan stands</b>	Cast Iron	<b>Feet</b>	Silver
<b>Type of control setting</b>	Control knobs		

## Programs / Functions

No. of cooking functions	9
--------------------------	---

## Traditional cooking functions

 Static	 Circulaire	 Turbo
 Eco	 Small grill	 Large grill
 Fan grill (large)	 Fan assisted bottom	 Pizza

Recipes

No























Cleaning functions

 Vapor clean
--

## Hob technical features

			
<b>Total no. of cook zones</b>	4		
Front left - Gas - UR	4.20 kW		
Rear left - Gas - Semi Rapid	1.80 kW		
Rear right - Gas - Semi Rapid	1.80 kW		
Front right - Gas - AUX	1.00 kW		
<b>Type of gas burners</b>	Standard	<b>Gas safety valves</b>	Yes
<b>Automatic electronic ignition</b>	Yes	<b>Burner caps</b>	Matt black enamelled

## Main Oven Technical Features

																											
<b>Fan number</b>	1	<b>Total no. of door glasses</b>	3																								
<b>Net volume of the cavity</b>	70 l	<b>No. of thermo-reflective door glasses</b>	1																								
<b>Gross volume, 1st cavity</b>	79 l	<b>Safety Thermostat</b>	Yes																								
<b>Cavity material</b>	Ever Clean enamel	<b>Cooling system</b>	Tangential																								
<b>No. of shelves</b>	5	<b>Usable cavity space dimensions (HxWxD)</b>	360X460X425 mm																								
<b>Type of shelves</b>	Metal racks	<b>Temperature control</b>	Electro-mechanical																								
<b>Roof Liner</b>	No	<b>Lower heating element power</b>	1200 W																								
<b>Light type</b>	Halogen	<b>Upper heating element - Power</b>	1000 W																								
<b>Light Power</b>	40 W	<b>Grill element</b>	1700 W																								
<b>Cooking time setting</b>	Conta-minutos + cozimento fino	<b>Large grill - Power</b>	2700 W																								
<b>Light when oven door is open</b>	No	<b>Circular heating element - Power</b>	2000 W																								
<b>Door opening</b>	Flap down	<b>Grill type</b>	Electric																								
<b>Removable door</b>	Yes	<b>Tilting grill</b>	No																								
<b>Full glass inner door</b>	Yes	<b>Soft Close system</b>	No																								
<b>Removable inner door</b>	Yes																										

## Options Main Oven

Timer	No	Minimum Temperature	50 °C
End of cooking acoustic alarm	Yes	Maximum temperature	260 °C

## Accessories included for Main Oven & Hob

Moka stand	1	40mm deep tray	1
Rack com batente traseiro e lateral	1	Grill mesh	1

## Electrical Connection

Plug	No	Electric cable	Installed, Single phase
Electrical connection rating	3000 W	Comprimento do cabo de alimentação	115 cm
Current	13 A	Frequency	50/60 Hz
Voltage	220-240 V	Bloco de terminais	3 polos

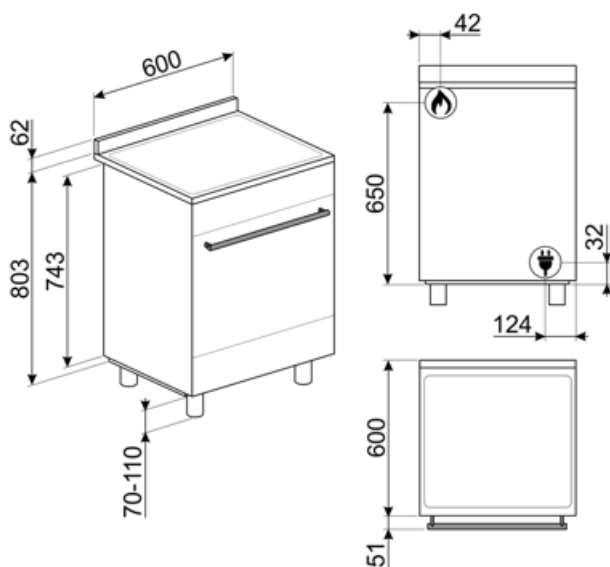

## Compatible Accessories

### AIRFRY

Air fryer rack AIRFRY . Ideal for recreating traditional frying in the oven, but with fewer calories and less fat. It allows you to cook quickly and simply dishes such as French fries, fried vegetables and fish, ensuring perfect browning and crispiness.



### BGTR9

Placa para grelhar de ferro fundido adequada para fogões Victoria 90 cm, Master e Sinfonia de 60 e 90 cm



### BN640

Tabuleiro esmaltado, 40mm de profundidade

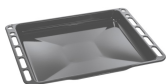

### GTP

\*\* Guias telescópicas parcialmente extraíveis (1 nível)\*\* Extração: 300 mm Material: Aço inoxidável AISI 430 polido



### KITC6X

Painel anti-salpicos, 60x75 cm, aço inoxidável, adequado para fogões Master e Sinfonia

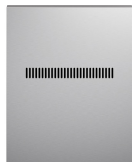

### PALPZ

Pá para pizza com alça dobrável largura: 315mm comprimento : 325mm



### SMOLD

Conjunto de 7 moldes de silicone para sorvetes, gelados, pralinés, cubos de gelo ou para porção de alimentos. Utilizável de -60°C a +230°C

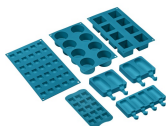

### WOKGHU

Suporte de ferro fundido para WOK



### BBQ

Double sided plate BBQ. Suitable for recreating succulent and crispy dishes in the oven with the typical taste of grilled cooking. The ribbed side is particularly suitable for meats and cheeses. The smooth side for fish, seafood and vegetables.



### BN620-1

Tabuleiro esmaltado, 20mm de profundidade



### BNP608T

Bandeja revestida de teflon, 8mm de profundidade, a ser colocada na grade



### GTT

\*\* Guias telescópicas totalmente extraíveis (1 nível)\*\* Extração: 433 mm Material: Aço inoxidável AISI 430 polido



### KITPBX

Pés de redução de altura (850 mm)



### SFLK1

Bloqueio para crianças

















### STONE

Pedra refratária retangular Ideal para cozinhar pizzas com os mesmos resultados de um forno típico a lenha. Também pode ser usado para assar pães, focaccias e outras receitas como tortas, flans ou biscoitos Dimensões:L42 x H1,8 x P37,5 cm.



## Symbols glossary

	Suportes de ferro fundido para serviço pesado: para máxima estabilidade e resistência.		R: Desempenho de secagem do produto, medido de A++ a D/G, dependendo da família de produtos
	Instalação em coluna: Instalação em coluna		Controle dos botões
	Sistema de arrefecimento a ar: para garantir temperaturas de superfície seguras.		Portas envidraçadas triplas: Número de portas envidraçadas.
	Interior esmaltado: O interior em esmalte de todos os fornos Smeg tem um revestimento antiácido especial que ajuda a manter o interior limpo, reduzindo a quantidade de gordura de cozimento aderente a ele.		Aço inoxidável à prova de dedadas: O aço inoxidável à prova de dedadas mantém o aço inoxidável com um aspeto novo.
	Circogas: Em fornos a gás, o ventilador distribui o calor de forma rápida e uniforme por toda a cavidade do forno, evitando a transferência de sabor ao cozinhar vários pratos diferentes ao mesmo tempo. Em fornos elétricos, esta combinação completa o cozimento mais rapidamente de alimentos que estão prontos na superfície, mas que exigem mais cozimento no interior, sem mais escurecimento.		Somente elementos superior e inferior: um método de cozimento tradicional mais adequado para itens individuais localizados no centro do forno. A parte superior do forno será sempre mais quente. Ideal para assados, bolos de frutas, pão, etc.
	Circulaire: A combinação do ventilador e do elemento circular em torno dele dá um método de cozimento de ar quente. Isso oferece muitos benefícios, incluindo nenhum pré-aquecimento se o tempo de cozimento for superior a 20 minutos, nenhuma transferência de sabor ao cozinhar alimentos diferentes ao mesmo tempo, menos energia e tempos de cozimento mais curtos. Bom para todos os tipos de alimentos.		ECO: A combinação da grelha, ventilador e elemento inferior é particularmente adequada para cozinhar pequenas quantidades de alimentos.
	Elemento de grelha O uso de grelha dá excelentes resultados ao cozinhar carne de porções médias e pequenas, especialmente quando combinada com uma rotisseria (sempre que possível). Também é ideal para cozinhar salsichas e bacon.		Meia grelha: Para cozinhar rapidamente e dourar os alimentos. Os melhores resultados podem ser obtidos usando a prateleira superior para itens pequenos, as prateleiras inferiores para os maiores, como costeletas ou salsichas. Para metade do calor da grelha é gerado apenas no centro do elemento, por isso é ideal para quantidades menores.



Ventilador com elemento de grelha: O ventilador reduz o calor feroz da grelha, proporcionando um excelente método de grelhar vários alimentos, costeletas, bifes, salsichas, etc. dando o mesmo escurecimento e distribuição de calor, sem secar os alimentos. Os dois níveis superiores recomendados para uso e a parte inferior do forno podem ser usados para manter os itens quentes ao mesmo tempo, uma excelente facilidade ao cozinhar um café da manhã grelhado. Meia grelha (apenas porção central) é ideal para pequenas quantidades de alimentos.



Função pizza: A operação simultânea de três elementos garante uma instalação de cozimento ideal quando usado com a pedra para pizza Smeg.



Circulaire com elementos superior e inferior: O uso do ventilador com ambos os elementos permite que os alimentos sejam cozinhados de forma rápida e eficaz, ideal para grandes peças que exigem cozimento completo. Oferece um resultado semelhante ao da rotisseria, movendo o calor em torno do alimento, em vez de mover o próprio alimento, permitindo que qualquer tamanho ou forma seja cozida.



Toda a porta interna de vidro: Toda a porta interna de vidro, uma única superfície plana que é simples de manter limpa.



O vidro interior da porta: pode ser removido com alguns movimentos rápidos para limpeza.



Luzes laterais: Duas luzes laterais opostas aumentam a visibilidade dentro do forno.



Abertura automática: alguns modelos têm porta de abertura automática quando o ciclo é terminado, o que é uma solução perfeita para unidades de cozinha sem alça, pois nenhuma alça é necessária. Por razões de segurança, a porta trava automaticamente quando a máquina está em uso para evitar que seja aberta inadvertidamente.



O compartimento do forno tem 5 níveis de cozimento diferentes.



Queimadores ultrarrápidos: Queimadores ultrarrápidos potentes oferecem até 5kw de potência.



Limpeza a Vapor: uma função de limpeza simples que utiliza vapor para afrouxar os depósitos no compartimento do forno.



A capacidade indica a quantidade de espaço útil no compartimento do forno em litros.

## Benefit (TT)

---

### **Gas hob**

Gas provides permanent control of the heat source and the temperature change is immediate

Equipped with a thermocouple, the gas supply is cut off if the flame is extinguished for greater safety.

### **Vapor Clean**

By inserting water into a recess at the bottom of the cavity, steam is generated, which softens the residue and facilitates its removal

By inserting water into a recess at the bottom of the cavity, steam is generated, which softens the residue and facilitates its removal.

### **Storage compartment**

More space thanks to the lower compartment, ideal for storing accessories or cooking utensils

### **True-convection**

The best cooking performances guaranteed by ventilated circular flow

Multiple fans and heating elements guarantee the perfect aerodynamic heat flow, allowing homogeneous and quicker cooking inside the cavity.

### **Multilevel cooking**

Several cooking levels allow maximum flexibility of use

### **Multilevel halogen light**

Internal halogen lighting on different levels guarantees excellent visibility

### **Removable inner glass**

Internal door glasses are easily removable for complete cleaning

### **Tangential cooling**

New cooling system with tangential fan and airflow from the door to the splashback

### **Isothermic Cavity**

The best cooking performance at the highest energy efficiency

### **Cold door**

During any function, the external door glass is cold, avoiding any risk of burns

### **AirFry (AIRFRY optional accessory)**

Lighter and tastier food thanks to airfry basket (optional accessory)

**BBQ (optional accessory)**

Barbeque cooking directly in the oven with the double-sided grill (BBQ optional accessory)

**Pizza stone (optional accessory)**

Baking with refractory stone for soft and crispy pizza and yeast products (STONE optional accessory)

**Adjustable height**

Cooker top flushed with the working area thanks to adjustable feet

**Single turbine**

The oven has a fan equipped with a circular heating element allowing cooking with rotating heat