

B71GMX2

Cooker size	70x60 cm
N.º de cavidades com rótulo energético	1
Fonte de calor da cavidade	ELECTRICITY
Hob type	Gas
Tipo de forno principal	Thermo-ventilated
Sistema de limpeza no forno principal	Vapor Clean
EAN code	8017709329181
Energy efficiency class	A



Aesthetics











Aesthetic	Classica	Type of control setting	Control knobs
Serie	Mestre	Control knobs	Smeg Master Glass
Design	Square design	Controls colour	Black
Colour	Stainless steel	No. of controls	8
Acabamento	Satin	Cor da serigrafia	Serigrafia em preto
Command panel finish	Finger friendly stainless steel	Display	No
Logo	Logotipo aplicado	Door	With 2 horizontal strips
Posição do logotipo	Logotipo no painel abaixo do forno	Glass type	Black
Upstand	Yes	Handle	Smeg Classic
Cor da placa	Stainless steel	Handle Colour	Brushed stainless steel
Type of pan stands	Cast Iron	Feet	Silver

Programs / Functions

No. of cooking functions 9

Traditional cooking functions

 Static	 Fan assisted	 Turbo
 Eco	 Small grill	 Large grill
 Fan grill (large)	 Fan assisted bottom	 Pizza

Recipes No
 Cleaning functions

 Vapor clean

Hob technical features

 **UR**

Total no. of cook zones 5
 Front left - Gas - AUX - 1.00 kW
 Rear left - Gas - Semi Rapid - 1.80 kW
 Central - Gas - UR - 4.20 kW
 Rear right - Gas - Semi Rapid - 1.80 kW
 Front right - Gas - AUX - 1.00 kW

Type of gas burners	Standard	Gas safety valves	Yes
Automatic electronic ignition	Yes	Burner caps	Matt black enamelled

Main Oven Technical Features



Fan number	1	Removable inner door	Yes
Net volume of the cavity	70 l	Total no. of door glasses	3
Gross volume, 1st cavity	79 l	No. of thermo-reflective door glasses	2
Cavity material	Ever Clean enamel	Safety Thermostat	Yes
No. of shelves	5	Heating suspended when door is opened	No
Type of shelves	Metal racks	Cooling system	Tangential
Roof Liner	No	Usable cavity space dimensions (HxWxD)	360X460X425 mm
Light type	Halogen	Temperature control	Electro-mechanical
Light Power	40 W	Lower heating element power	1200 W
Cooking time setting	Conta-minutos + cozimento fino	Upper heating element - Power	1000 W
Light when oven door is open	Yes	Grill element	1700 W
Door opening	Flap down	Large grill - Power	2700 W
Removable door	Yes	Circular heating element - Power	2000 W
Full glass inner door	Yes	Grill type	Electric

Options Main Oven

Timer	No	Minimum Temperature	50 °C
End of cooking acoustic alarm	Yes	Maximum temperature	260 °C

Accessories included for Main Oven & Hob

Moka stand	1	40mm deep tray	1
Rack com batente traseiro e lateral	1		

Electrical Connection

Plug	No	Electric cable	Installed, Single phase
Electrical connection rating	3000 W	Comprimento do cabo de alimentação	115 cm
Current	13 A	Frequency	50/60 Hz
Voltage	220-240 V	Bloco de terminais	3 polos

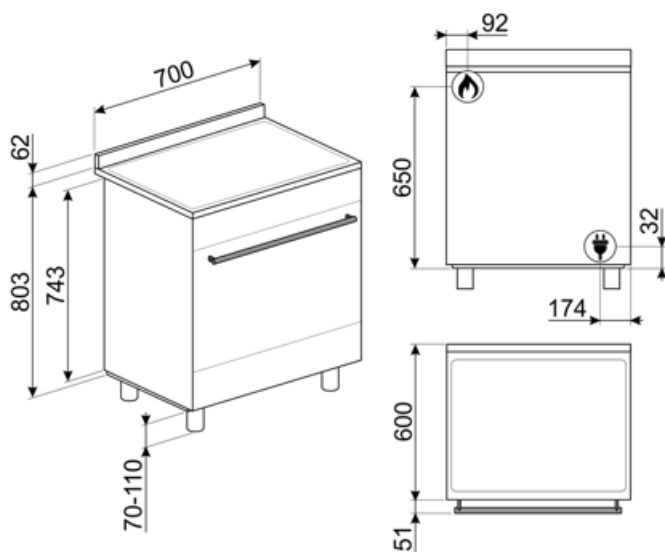

Compatible Accessories

AIRFRY

Air fryer rack AIRFRY . Ideal for recreating traditional frying in the oven, but with fewer calories and less fat. It allows you to cook quickly and simply dishes such as French fries, fried vegetables and fish, ensuring perfect browning and crispiness.



BN620-1

Tabuleiro esmaltado, 20mm de profundidade



BNP608T

Bandeja revestida de teflon, 8mm de profundidade, a ser colocada na grade



GTT

** Guias telescópicas totalmente extraíveis (1 nível)** Extração: 433 mm
Material: Aço inoxidável AISI 430 polido



KITPBX

Pés de redução de altura (850 mm)



SMOLD

Conjunto de 7 moldes de silicone para sorvetes, gelados, pralinés, cubos de gelo ou para porção de alimentos. Utilizável de -60°C a +230°C

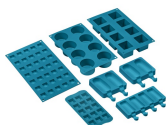

BBQ

Double sided plate BBQ. Suitable for recreating succulent and crispy dishes in the oven with the typical taste of grilled cooking. The ribbed side is particularly suitable for meats and cheeses. The smooth side for fish, seafood and vegetables.



BN640

Tabuleiro esmaltado, 40mm de profundidade

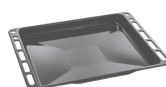

GTP

** Guias telescópicas parcialmente extraíveis (1 nível)** Extração: 300 mm
Material: Aço inoxidável AISI 430 polido



KITC7X

Painel anti-salpicos, 70x75 cm, aço inoxidável, adequado para fogões Master e Sinfonia



SFLK1

Bloqueio para crianças



























WOKGHU

Suporte de ferro fundido para WOK



Symbols glossary

-  R: Desempenho de secagem do produto, medido de A++ a D/G, dependendo da família de produtos
-  Instalação em coluna: Instalação em coluna
-  Portas envidraçadas triplas: Número de portas envidraçadas.
-  Aço inoxidável à prova de dedadas: O aço inoxidável à prova de dedadas mantém o aço inoxidável com um aspeto novo.
-  Ventilador com elementos superiores e inferiores: Os elementos combinados com o ventilador visam fornecer calor mais uniforme, um método semelhante ao cozimento convencional, de modo que o pré-aquecimento é necessário. Mais adequado para itens que exigem métodos de cozimento lento.
-  ECO: A combinação da grelha, ventilador e elemento inferior é particularmente adequada para cozinhar pequenas quantidades de alimentos.
-  Meia grelha: Para cozinhar rapidamente e dourar os alimentos. Os melhores resultados podem ser obtidos usando a prateleira superior para itens pequenos, as prateleiras inferiores para os maiores, como costeletas ou salsichas. Para metade do calor da grelha é gerado apenas no centro do elemento, por isso é ideal para quantidades menores.
-  Suportes de ferro fundido para serviço pesado: para máxima estabilidade e resistência.
-  Sistema de arrefecimento a ar: para garantir temperaturas de superfície seguras.
-  Interior esmaltado: O interior em esmalte de todos os fornos Smeg tem um revestimento antiácido especial que ajuda a manter o interior limpo, reduzindo a quantidade de gordura de cozimento aderente a ele.
-  Circogas: Em fornos a gás, o ventilador distribui o calor de forma rápida e uniforme por toda a cavidade do forno, evitando a transferência de sabor ao cozinhar vários pratos diferentes ao mesmo tempo. Em fornos elétricos, esta combinação completa o cozimento mais rapidamente de alimentos que estão prontos na superfície, mas que exigem mais cozimento no interior, sem mais escurecimento.
-  Somente elementos superior e inferior: um método de cozimento tradicional mais adequado para itens individuais localizados no centro do forno. A parte superior do forno será sempre mais quente. Ideal para assados, bolos de frutas, pão, etc.
-  Elemento de grelha O uso de grelha dá excelentes resultados ao cozinhar carne de porções médias e pequenas, especialmente quando combinada com uma rotisseria (sempre que possível). Também é ideal para cozinhar salsichas e bacon.
-  Ventilador com elemento de grelha: O ventilador reduz o calor feroz da grelha, proporcionando um excelente método de grelhar vários alimentos, costeletas, bifés, salsichas, etc. dando o mesmo escurecimento e distribuição de calor, sem secar os alimentos. Os dois níveis superiores recomendados para uso e a parte inferior do forno podem ser usados para manter os itens quentes ao mesmo tempo, uma excelente facilidade ao cozinhar um café da manhã grelhado. Meia grelha (apenas porção central) é ideal para pequenas quantidades de alimentos.

-  **Função pizza:** A operação simultânea de três elementos garante uma instalação de cozimento ideal quando usado com a pedra para pizza Smeg.
-  **Toda a porta interna de vidro:** Toda a porta interna de vidro, uma única superfície plana que é simples de manter limpa.
-  **Luzes laterais:** Duas luzes laterais opostas aumentam a visibilidade dentro do forno.
-  **O compartimento do forno tem 5 níveis de cozimento diferentes.**
-  **Limpeza a Vapor:** uma função de limpeza simples que utiliza vapor para afrouxar os depósitos no compartimento do forno.
-  **Controle dos botões**
-  **Circulaire com elementos superior e inferior:** O uso do ventilador com ambos os elementos permite que os alimentos sejam cozinhados de forma rápida e eficaz, ideal para grandes peças que exigem cozimento completo. Oferece um resultado semelhante ao da rotisseria, movendo o calor em torno do alimento, em vez de mover o próprio alimento, permitindo que qualquer tamanho ou forma seja cozida.
-  **O vidro interior da porta:** pode ser removido com alguns movimentos rápidos para limpeza.
-  **Abertura automática:** alguns modelos têm porta de abertura automática quando o ciclo é terminado, o que é uma solução perfeita para unidades de cozinha sem alça, pois nenhuma alça é necessária. Por razões de segurança, a porta trava automaticamente quando a máquina está em uso para evitar que seja aberta inadvertidamente.
-  **Queimadores ultrarrápidos:** Queimadores ultrarrápidos potentes oferecem até 5kw de potência.
-  **A capacidade indica a quantidade de espaço útil no compartimento do forno em litros.**

Benefit (TT)

Gas hob

Gas provides permanent control of the heat source and the temperature change is immediate

Equipped with a thermocouple, the gas supply is cut off if the flame is extinguished for greater safety.

Vapor Clean

By inserting water into a recess at the bottom of the cavity, steam is generated, which softens the residue and facilitates its removal

By inserting water into a recess at the bottom of the cavity, steam is generated, which softens the residue and facilitates its removal.

Knobs control

Easy and intuitive timer setting with a elegant knobs

Storage compartment

More space thanks to the lower compartment, ideal for storing accessories or cooking utensils

True-convection

The best cooking performances guaranteed by ventilated circular flow

Multiple fans and heating elements guarantee the perfect aerodynamic heat flow, allowing homogeneous and quicker cooking inside the cavity.

Multilevel cooking

Several cooking levels allow maximum flexibility of use

Multilevel halogen light

Internal halogen lighting on different levels guarantees excellent visibility

Removable inner glass

Internal door glasses are easily removable for complete cleaning

Tangential cooling

New cooling system with tangential fan and airflow from the door to the splashback

Isothermic Cavity

The best cooking performance at the highest energy efficiency

BBQ (optional accessory)

Barbeque cooking directly in the oven with the double-sided grill (BBQ optional accessory)

Pizza stone (optional accessory)

Baking with refractory stone for soft and crispy pizza and yeast products (STONE optional accessory)

Cold door

During any function, the external door glass is cold, avoiding any risk of burns

AirFry (AIRFRY optional accessory)

Lighter and tastier food thanks to airfry basket (optional accessory)

Adjustable height

Cooker top flushed with the working area thanks to adjustable feet

Single turbine

The oven has a fan equipped with a circular heating element allowing cooking with rotating heat