

# BG91CTN9-1

Cooker size	90x60 cm
N.º de cavidades com rótulo energético	1
Fonte de calor da cavidade	ELECTRICITY
Hob type	Gas
Tipo de forno principal	Thermo-ventilated
Sistema de limpeza no forno principal	Catalytic
EAN code	8017709279646
Energy efficiency class	A



## Aesthetics



<b>Aesthetic</b>	Classica	<b>Control knobs</b>	Smeg USA
<b>Serie</b>	Concerto	<b>Controls colour</b>	Soft touch black
<b>Design</b>	Standard	<b>No. of controls</b>	7
<b>Colour</b>	Black	<b>Cor da serigrafia</b>	Serigrafia em prateado
<b>Command panel finish</b>	Enamelled metal	<b>Display</b>	Touch
<b>Logo</b>	Logotipo aplicado	<b>Door</b>	With 2 horizontal strips
<b>Posição do logotipo</b>	Logotipo no painel abaixo do forno	<b>Glass type</b>	Stopsol
<b>Upstand</b>	Yes	<b>Handle</b>	Smeg Classic
<b>Cor da placa</b>	Stainless steel	<b>Handle Colour</b>	Brushed stainless steel
<b>Type of pan stands</b>	Cast Iron	<b>Storage compartment</b>	Door
<b>Type of control setting</b>	Control knobs	<b>Feet</b>	Silver

## Programs / Functions

No. of cooking functions 8

Traditional cooking functions



Static

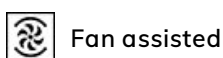

Fan assisted



Circulaire



Eco



Large grill

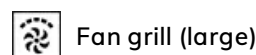

Fan grill (large)



Fan assisted bottom

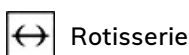

Rotisserie

## Cleaning functions

Catalytic



Vapor clean

## Hob technical features



**Total no. of cook zones** 5

Front left - Gas - Rapid - 2.90 kW

Rear left - Gas - Semi Rapid - 1.80 kW

Central - Gas - UR - 4.00 kW

Rear right - Gas - Semi Rapid - 1.80 kW

Front right - Gas - AUX - 1.00 kW

**Type of gas burners** Standard

**Gas safety valves** Yes

**Automatic electronic ignition** Yes

**Burner caps** Matt black enamelled

## Main Oven Technical Features



**No. of lights** 2

**Fan number** 2

**Net volume of the cavity** 115 l

**Gross volume, 1st cavity** 129 l

**Cavity material** Ever Clean enamel

**No. of shelves** 5

**Type of shelves** Metal racks

**Roof Liner** No

**Light type** Halogen

**Light Power** 40 W

**Cooking time setting** Start and Stop

**Light when oven door is open** Yes

**Door opening** Flap down

**Removable door** Yes

**Full glass inner door** Yes

**Removable inner door** Yes

**Total no. of door glasses** 3

**No. of thermo-reflective door glasses** 2

**Safety Thermostat** Yes

**Cooling system** Tangential

**Usable cavity space dimensions (HxWxD)** 371x724x418 mm

**Temperature control** Electro-mechanical

**Lower heating element power** 1700 W

**Upper heating element - Power** 1200 W

**Grill element** 1700 W

**Large grill - Power** 2900 W

**Circular heating element - Power** 2 x 1550 W

**Grill type** Electric

**Tilting grill** No

**Soft Close system** No

## Options Main Oven

**Timer** Yes

**End of cooking acoustic alarm** Yes

**Minimum Temperature** 50 °C

**Maximum temperature** 260 °C

## Accessories included for Main Oven & Hob

Rack com batente traseiro e lateral	1	Grill mesh	1
40mm deep tray	1	Catalityc panels	3

## Electrical Connection

Plug	No	Voltage	220-240 V
Electrical connection rating	3200 W	Frequency	50/60 Hz
Current	14 A	Bloco de terminais	3 polos

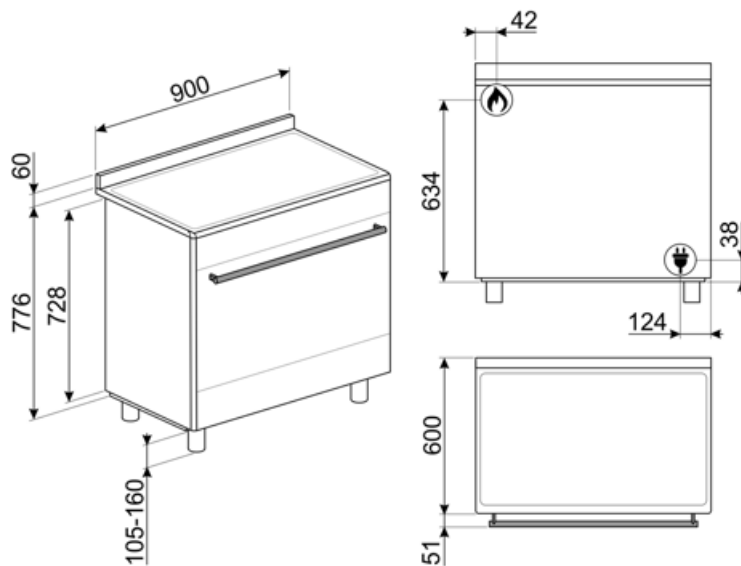

## Compatible Accessories

### AIRFRY9

Air fryer rack AIRFRY . Ideal for recreating traditional frying in the oven, but with fewer calories and less fat. It allows you to cook quickly and simply dishes such as French fries, fried vegetables and fish, ensuring perfect browning and crispiness.



### BBQ9



### BN920

### GTP

\*\* Guias telescópicas parcialmente extraíveis (1 nível)\*\* Extração: 300 mm  
Material: Aço inoxidável AISI 430 polido



### KIT600SNL-9

Faixa de cobertura para placa traseira, adequado para fogões Concerto 90 centímetros



### KIT90X9-1

Painel anti-salpicos, 90x60 cm, aço inoxidável, para fogões Concerto



### KITH95

Kit extensão de altura (950 mm), aço inoxidável

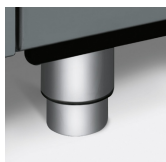

### KITROT9

Kit Rotisseria para fogões 90x60, nova cavidade (115 L)



### PALPZ

Pá para pizza com alça dobrável  
largura: 315mm comprimento : 325mm



### AL90X9

Suporte adequado para fogões Concerto de 90 cm SX91



### BG6090-1

Placa grelhadora de ferro fundido adequada para fogões Concerto



### BN940

### GTT

\*\* Guias telescópicas totalmente extraíveis (1 nível)\*\* Extração: 433 mm  
Material: Aço inoxidável AISI 430 polido



### KIT90N9

Painel anti-salpicos 90 cm, preto, para fogões BU & BM



### KITH900BG91

Rodapé, 90cm, três lados, preto, adequado para fogões BG91



### KITPDQ

Pés de redução de altura (850 mm), de aço inoxidável, para fogões



### KITSB9MB



### PPR9

Pedra para pizza refratária sem pegas. Pedra em forma quadrada: L64xH2,3xP37,5 cm Adequada também para fornos a gás, para ser colocada na grelha.





### SFLK1



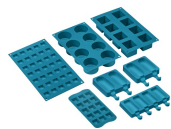











Bloqueio para crianças













### SMOLD

Conjunto de 7 moldes de silicone para sorvetes, gelados, pralinés, cubos de gelo ou para porção de alimentos. Utilizável de -60°C a +230°C

## Symbols glossary

-  Suportes de ferro fundido para serviço pesado: para máxima estabilidade e resistência.
-  R: Desempenho de secagem do produto, medido de A++ a D/G, dependendo da família de produtos
-  Controle dos botões
-  Portas envidraçadas triplas: Número de portas envidraçadas.
-  Circogas: Em fornos a gás, o ventilador distribui o calor de forma rápida e uniforme por toda a cavidade do forno, evitando a transferência de sabor ao cozinhar vários pratos diferentes ao mesmo tempo. Em fornos elétricos, esta combinação completa o cozimento mais rapidamente de alimentos que estão prontos na superfície, mas que exigem mais cozimento no interior, sem mais escurecimento.
-  Somente elementos superior e inferior: um método de cozimento tradicional mais adequado para itens individuais localizados no centro do forno. A parte superior do forno será sempre mais quente. Ideal para assados, bolos de frutas, pão, etc.
-  ECO: A combinação da grelha, ventilador e elemento inferior é particularmente adequada para cozinhar pequenas quantidades de alimentos.
-  Limpeza catalítica: o sistema garante uma higiene perfeita no interior do forno graças aos três painéis de autolimpeza revestidos com um esmalte especial que promove a eliminação progressiva de vestígios de gordura e odores causados pelo cozimento.
-  Instalação em coluna: Instalação em coluna
-  Sistema de arrefecimento a ar: para garantir temperaturas de superfície seguras.
-  Interior esmaltado: O interior em esmalte de todos os fornos Smeg tem um revestimento antiácido especial que ajuda a manter o interior limpo, reduzindo a quantidade de gordura de cozimento aderente a ele.
-  Ventilador com elementos superiores e inferiores: Os elementos combinados com o ventilador visam fornecer calor mais uniforme, um método semelhante ao cozimento convencional, de modo que o pré-aquecimento é necessário. Mais adequado para itens que exigem métodos de cozimento lento.
-  Circulaire: A combinação do ventilador e do elemento circular em torno dele dá um método de cozimento de ar quente. Isso oferece muitos benefícios, incluindo nenhum pré-aquecimento se o tempo de cozimento for superior a 20 minutos, nenhuma transferência de sabor ao cozinhar alimentos diferentes ao mesmo tempo, menos energia e tempos de cozimento mais curtos. Bom para todos os tipos de alimentos.
-  Elemento de grelha O uso de grelha dá excelentes resultados ao cozinhar carne de porções médias e pequenas, especialmente quando combinada com uma rotisseria (sempre que possível). Também é ideal para cozinhar salsichas e bacon.

-  Ventilador com elemento de grelha: O ventilador reduz o calor feroz da grelha, proporcionando um excelente método de grelhar vários alimentos, costeletas, bifés, salsichas, etc. dando o mesmo escurecimento e distribuição de calor, sem secar os alimentos. Os dois níveis superiores recomendados para uso e a parte inferior do forno podem ser usados para manter os itens quentes ao mesmo tempo, uma excelente facilidade ao cozinhar um café da manhã grelhado. Meia grelha (apenas porção central) é ideal para pequenas quantidades de alimentos.
-  Toda a porta interna de vidro: Toda a porta interna de vidro, uma única superfície plana que é simples de manter limpa.
-  Luzes laterais: Duas luzes laterais opostas aumentam a visibilidade dentro do forno.
-  O compartimento do forno tem 5 níveis de cozimento diferentes.
-  Limpeza a Vapor: uma função de limpeza simples que utiliza vapor para afrouxar os depósitos no compartimento do forno.
-  ...
-  Rotisseria: A rotisseria (quando instalada) funciona em combinação com o elemento de grelha para alimentos assados com perfeição.
-  O vidro interior da porta: pode ser removido com alguns movimentos rápidos para limpeza.
-  Abertura automática: alguns modelos têm porta de abertura automática quando o ciclo é terminado, o que é uma solução perfeita para unidades de cozinha sem alça, pois nenhuma alça é necessária. Por razões de segurança, a porta trava automaticamente quando a máquina está em uso para evitar que seja aberta inadvertidamente.
-  Queimadores ultrarrápidos: Queimadores ultrarrápidos potentes oferecem até 5kw de potência.
-  A capacidade indica a quantidade de espaço útil no compartimento do forno em litros.

## Benefit (TT)

---

### **Gas hob**

Gas provides permanent control of the heat source and the temperature change is immediate

Equipped with a thermocouple, the gas supply is cut off if the flame is extinguished for greater safety.

### **Catalysis**

Easy oven cleaning through the use of catalytic panels in the cavity

This permanent process allows continuous cleaning and degreasing of the three cavity walls, starting its grease oxidation phase when the oven reaches 200°C.

### **Touch control**

Easy and intuitive timer setting with a single touch

### **Storage compartment**

More space thanks to the lower compartment, ideal for storing accessories or cooking utensils

### **True-convection**

The best cooking performances guaranteed by ventilated circular flow

Multiple fans and heating elements guarantee the perfect aerodynamic heat flow, allowing homogeneous and quicker cooking inside the cavity.

### **Multilevel cooking**

Several cooking levels allow maximum flexibility of use

### **Multilevel halogen light**

Internal halogen lighting on different levels guarantees excellent visibility

### **Removable inner glass**

Internal door glasses are easily removable for complete cleaning

### **Tangential cooling**

New cooling system with tangential fan and airflow from the door to the splashback

### **Isothermic Cavity**

The best cooking performance at the highest energy efficiency

### **BBQ (optional accessory)**

Barbeque cooking directly in the oven with the double-sided grill (BBQ optional accessory)



---

**Pizza stone (optional accessory)**

Baking with refractory stone for soft and crispy pizza and yeast products (STONE optional accessory)

**Cold door**

During any function, the external door glass is cold, avoiding any risk of burns

**AirFry (AIRFRY optional accessory)**

Lighter and tastier food thanks to airfry basket (optional accessory)

**Adjustable height**

Cooker top flushed with the working area thanks to adjustable feet

**Double Turbine**

The oven has two fans equipped with two circular heating elements allowing cooking with rotating heat