

# BG91PX9-1

Cooker size	90x60 cm
N.º de cavidades com rótulo energético	1
Fonte de calor da cavidade	ELECTRICITY
Hob type	Gas
Tipo de forno principal	Thermo-ventilated
Sistema de limpeza no forno principal	Pyrolitic
EAN code	8017709279615
Energy efficiency class	A+



## Aesthetics











<b>Aesthetic</b>	Classica	<b>Control knobs</b>	Smeg USA
<b>Serie</b>	Concerto	<b>Controls colour</b>	Soft touch black
<b>Design</b>	Standard	<b>No. of controls</b>	7
<b>Colour</b>	Stainless steel	<b>Cor da serigrafia</b>	Serigrafia em preto
<b>Acabamento</b>	Satin	<b>Display</b>	Touch
<b>Command panel finish</b>	Stainless steel	<b>Door</b>	With 2 horizontal strips
<b>Logo</b>	Logotipo embutido	<b>Glass type</b>	Stopsol
<b>Posição do logotipo</b>	Logotipo no painel abaixo do forno	<b>Handle</b>	Smeg Classic
<b>Upstand</b>	Yes	<b>Handle Colour</b>	Brushed stainless steel
<b>Cor da placa</b>	Stainless steel	<b>Storage compartment</b>	Door
<b>Type of pan stands</b>	Cast Iron	<b>Feet</b>	Silver
<b>Type of control setting</b>	Control knobs		

## Programs / Functions

No. of cooking functions	9
--------------------------	---

### Traditional cooking functions

 Static	 Fan assisted	 Circulaire
 Turbo	 Eco	 Large grill
 Fan grill (large)	 Fan assisted bottom	 Rotisserie

### Recipes

No









### Cleaning functions

 Pyrolytic
--

## Hob technical features

			
<b>Total no. of cook zones</b>	5		
Front left - Gas - Rapid	2.90 kW		
Rear left - Gas - Semi Rapid	1.80 kW		
Central - Gas - UR	4.00 kW		
Rear right - Gas - Semi Rapid	1.80 kW		
Front right - Gas - AUX	1.00 kW		
<b>Type of gas burners</b>	Standard	<b>Gas safety valves</b>	Yes
<b>Automatic electronic ignition</b>	Yes	<b>Burner caps</b>	Matt black enamelled

## Main Oven Technical Features

								
<b>No. of lights</b>	2	<b>Total no. of door glasses</b>	4					
<b>Fan number</b>	2	<b>No. of thermo-reflective door glasses</b>	2					
<b>Net volume of the cavity</b>	115 l	<b>Safety Thermostat</b>	Yes					
<b>Gross volume, 1st cavity</b>	129 l	<b>Cooling system</b>	Tangential					
<b>Cavity material</b>	Ever Clean enamel	<b>Door Lock During Pyrolysis</b>	Yes					
<b>No. of shelves</b>	5	<b>Usable cavity space dimensions (HxWxD)</b>	371x724x418 mm					
<b>Type of shelves</b>	Metal racks	<b>Temperature control</b>	Electro-mechanical					
<b>Light type</b>	Halogen	<b>Lower heating element power</b>	1700 W					
<b>Light Power</b>	40 W	<b>Upper heating element - Power</b>	1200 W					
<b>Cooking time setting</b>	Start and Stop	<b>Grill element</b>	1700 W					
<b>Light when oven door is open</b>	Yes	<b>Large grill - Power</b>	2900 W					
<b>Door opening</b>	Flap down							
<b>Removable door</b>	Yes							
<b>Full glass inner door</b>	Yes							
<b>Removable inner door</b>	Yes							

Circular heating element	2 x 2000 W
- Power	
Grill type	Electric
Soft Close system	No

## Options Main Oven

Timer	Yes	Minimum Temperature	50 °C
End of cooking acoustic alarm	Yes	Maximum temperature	260 °C

## Accessories included for Main Oven & Hob

Rack com batente traseiro e lateral	1	Grill mesh	1
40mm deep tray	1		

## Electrical Connection

Plug	No	Voltage 2 (V)	380-415 V
Electrical connection rating	4200 W	Frequency	50/60 Hz
Current	19 A	Bloco de terminais	5 polos
Voltage	220-240 V		

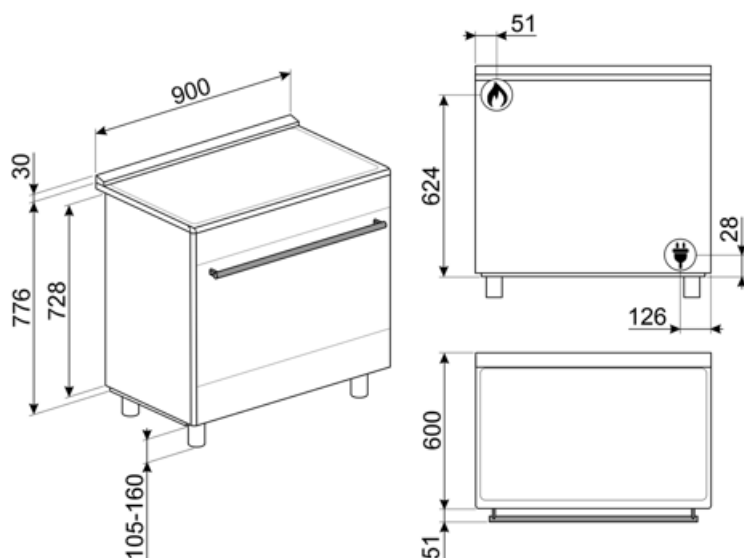

## Compatible Accessories

### AIRFRY9

Air fryer rack AIRFRY . Ideal for recreating traditional frying in the oven, but with fewer calories and less fat. It allows you to cook quickly and simply dishes such as French fries, fried vegetables and fish, ensuring perfect browning and crispiness.



### BG6090-1

Placa grelhadora de ferro fundido adequada para fogões Concerto



### BN940

### GTT

\*\* Guias telescópicas totalmente extraíveis (1 nível)\*\* Extração: 433 mm Material: Aço inoxidável AISI 430 polido



### KITH900BG91

Rodapé, 90cm, três lados, preto, adequado para fogões BG91



### KITP90X9

Painel anti-salpicos, 90 cm, aço inoxidável, adequado para fogões Concerto pirolíticos



### KITROT9

Kit Rotisseria para fogões 90x60, nova cavidade (115 L)



### PPR9

Pedra para pizza refratária sem pegas. Pedra em forma quadrada: L64xH2,3xP37,5 cm Adequada também para fornos a gás, para ser colocada na grelha.



### BBQ9



### BN920

### GTP

\*\* Guias telescópicas parcialmente extraíveis (1 nível)\*\* Extração: 300 mm Material: Aço inoxidável AISI 430 polido



### KIT600SNL-9

Faixa de cobertura para placa traseira, adequado para fogões Concerto 90 centímetros



### KITH95

Kit extensão de altura (950 mm), aço inoxidável



### KITPDQ

Pés de redução de altura (850 mm), de aço inoxidável, para fogões



### PALPZ

Pá para pizza com alça dobrável largura: 315mm comprimento : 325mm



### SFLK1

Bloqueio para crianças



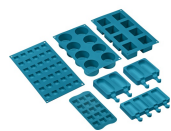

























### SMOLD

Conjunto de 7 moldes de silicone para sorvetes, gelados, pralinés, cubos de gelo ou para porção de alimentos.  
Utilizável de -60°C a +230°C

## Symbols glossary

-  Suportes de ferro fundido para serviço pesado: para máxima estabilidade e resistência.
-  Instalação em coluna: Instalação em coluna
-  Sistema de arrefecimento a ar: para garantir temperaturas de superfície seguras.
-  Quádruplo vidrado: Número de portas envidraçadas.
-  Circogas: Em fornos a gás, o ventilador distribui o calor de forma rápida e uniforme por toda a cavidade do forno, evitando a transferência de sabor ao cozinhar vários pratos diferentes ao mesmo tempo. Em fornos elétricos, esta combinação completa o cozimento mais rapidamente de alimentos que estão prontos na superfície, mas que exigem mais cozimento no interior, sem mais escurecimento.
-  Somente elementos superior e inferior: um método de cozimento tradicional mais adequado para itens individuais localizados no centro do forno. A parte superior do forno será sempre mais quente. Ideal para assados, bolos de frutas, pão, etc.
-  ECO: A combinação da grelha, ventilador e elemento inferior é particularmente adequada para cozinhar pequenas quantidades de alimentos.
-  Ventilador com elemento de grelha: O ventilador reduz o calor feroz da grelha, proporcionando um excelente método de grelhar vários alimentos, costeletas, bifés, salsichas, etc. dando o mesmo escurecimento e distribuição de calor, sem secar os alimentos. Os dois níveis superiores recomendados para uso e a parte inferior do forno podem ser usados para manter os itens quentes ao mesmo tempo, uma excelente facilidade ao cozinhar um café da manhã grelhado. Meia grelha (apenas porção central) é ideal para pequenas quantidades de alimentos.
-  A+: A classe de eficiência energética A+ ajuda a economizar até 10% de energia em comparação com a classe A. O desempenho máximo com consumo mínimo é garantido.
-  Controle dos botões
-  ...
-  Interior esmaltado: O interior em esmalte de todos os fornos Smeg tem um revestimento antiácido especial que ajuda a manter o interior limpo, reduzindo a quantidade de gordura de cozimento aderente a ele.
-  Ventilador com elementos superiores e inferiores: Os elementos combinados com o ventilador visam fornecer calor mais uniforme, um método semelhante ao cozimento convencional, de modo que o pré-aquecimento é necessário. Mais adequado para itens que exigem métodos de cozimento lento.
-  Circulaire: A combinação do ventilador e do elemento circular em torno dele dá um método de cozimento de ar quente. Isso oferece muitos benefícios, incluindo nenhum pré-aquecimento se o tempo de cozimento for superior a 20 minutos, nenhuma transferência de sabor ao cozinhar alimentos diferentes ao mesmo tempo, menos energia e tempos de cozimento mais curtos. Bom para todos os tipos de alimentos.
-  Elemento de grelha O uso de grelha dá excelentes resultados ao cozinhar carne de porções médias e pequenas, especialmente quando combinada com uma rotisseria (sempre que possível). Também é ideal para cozinhar salsichas e bacon.
-  Rotisseria: A rotisseria (quando instalada) funciona em combinação com o elemento de grelha para alimentos assados com perfeição.

- 
-  **Circulaire com elementos superior e inferior:** O uso do ventilador com ambos os elementos permite que os alimentos sejam cozinhados de forma rápida e eficaz, ideal para grandes peças que exigem cozimento completo. Oferece um resultado semelhante ao da rotisseria, movendo o calor em torno do alimento, em vez de mover o próprio alimento, permitindo que qualquer tamanho ou forma seja cozida.
-  **O vidro interior da porta:** pode ser removido com alguns movimentos rápidos para limpeza.
-  **Abertura automática:** alguns modelos têm porta de abertura automática quando o ciclo é terminado, o que é uma solução perfeita para unidades de cozinha sem alça, pois nenhuma alça é necessária. Por razões de segurança, a porta trava automaticamente quando a máquina está em uso para evitar que seja aberta inadvertidamente.
-  **O compartimento do forno tem 5 níveis de cozimento diferentes.**
-  **A capacidade indica a quantidade de espaço útil no compartimento do forno em litros.**
-  **Toda a porta interna de vidro:** Toda a porta interna de vidro, uma única superfície plana que é simples de manter limpa.
-  **Luzes laterais:** Duas luzes laterais opostas aumentam a visibilidade dentro do forno.
-  **Pirolítico:** Os ciclos de limpeza pirolítica podem ser selecionados conforme necessário para limpar automaticamente o interior do forno.
-  **Queimadores ultrarrápidos:** Queimadores ultrarrápidos potentes oferecem até 5kw de potência.

## Benefit (TT)

---

### **Gas hob**

Gas provides permanent control of the heat source and the temperature change is immediate  
Equipped with a thermocouple, the gas supply is cut off if the flame is extinguished for greater safety.

### **Pyrolysis**

Easy oven cleaning thanks to special pyrolytic function

### **Touch control**

Easy and intuitive timer setting with a single touch

### **Storage compartment**

More space thanks to the lower compartment, ideal for storing accessories or cooking utensils

### **True-convection**

The best cooking performances guaranteed by ventilated circular flow  
Multiple fans and heating elements guarantee the perfect aerodynamic heat flow, allowing homogeneous and quicker cooking inside the cavity.

### **Multilevel cooking**

Several cooking levels allow maximum flexibility of use

### **Multilevel halogen light**

Internal halogen lighting on different levels guarantees excellent visibility

### **Removable inner glass**

Internal door glasses are easily removable for complete cleaning

### **Tangential cooling**

New cooling system with tangential fan and airflow from the door to the splashback

### **Isothermic Cavity**

The best cooking performance at the highest energy efficiency

### **Cold door**

During any function, the external door glass is cold, avoiding any risk of burns

### **AirFry (AIRFRY optional accessory)**

Lighter and tastier food thanks to airfry basket (optional accessory)



**BBQ (optional accessory)**

Barbeque cooking directly in the oven with the double-sided grill (BBQ optional accessory)

**Pizza stone (optional accessory)**

Baking with refractory stone for soft and crispy pizza and yeast products (STONE optional accessory)

**Adjustable height**

Cooker top flushed with the working area thanks to adjustable feet

**Double Turbine**

The oven has two fans equipped with two circular heating elements allowing cooking with rotating heat