

BG91X2

Categorie fornuis	90x60 cm
N. of cavities with energy label	1
Cavity heat source	Elektriciteit
Type kookplaat	Gas
Type primaire oven	Thermogeventileerd
Reinigingssysteem primaire oven	Vapor Clean reiniging
EAN-code	8017709316709
Energie-efficiëntieklasse	A



Design



Design	Standaard	Bedieningsknoppen	Smeg Master Black
Afwerking bedieningspaneel	Inox	Kleur bedieningsknoppen	Zwart
Design Logo	Classici	Aantal bedieningsknoppen	7
Logo	In reliëf	Kleur serigrafie	Zwart
Kleur	Inox	Display	DigiScreen
Positie logo	Strook onder de oven	Deur	Met 2 horizontale stroken
Afwerking Upstand	Geborsteld inox	Type glas	Stopsol
Series	Ja	Handgreep	Smeg Classici
Kleur kookplaat	Concerto	Kleur handgreep	Geborsteld inox
Type pottendragers	Inox	Opbergruimte	Opbergvak met klep
Bediening	Gietijzeren pottendragers	Pootjes	Zilver
	Bedieningsknoppen		

Programma's / Functies

Aantal kookfuncties	8
---------------------	---

Traditionele bereidingsfuncties

Statisch	Geventileerd	Circulatie (ventilator + circulaire)
ECO	Kleine grill	Grote grill
Ventilator + grote grill	Geventileerde onderwarmte	

Reinigingsfuncties

Vapor Clean reiniging

Technische specificaties kookplaat

UR			
Totaal aantal kookzones	5		
Linksvoor - Gas - RP	2.90 kW		
Linksachter - Gas - SRD	1.80 kW		
Midden - Gas - URP	4.00 kW		
Rechtsachter - Gas - SRD	1.80 kW		
Rechtsvoor - Gas - AUX	1.00 kW		
Type gasbranders	Standaard	Thermobeveiliging	Ja
Automatische vonkontsteking	Ja	Branderdeksels	Mat zwart geëmailleerd

Technische specificaties primaire oven

Aantal lampen	2	Aantal ventilatoren	2	Netto volume 1e oven	115 l	Bruto volume, oven 1	129 l	Materiaal ovenruimte	Ever Clean emaille	Aantal kookniveaus	5	Type ovenrekken	Metalen zijsteunen	Type licht	Halogeen	Vermogen lamp	40 W	Opties bereidingstijdprogrammering	Begin en eind	Uitneembaar glas binnendeur	Ja	Aantal ruiten ovendeur	3	Aantal thermo-reflecterende ruiten	2	Veiligheidsthermostaat	Ja	Koelsysteem	Mantelkoeling	Afmetingen bruikbare interne ovenruimte (hxbxd)	371x724x418 mm	Temperatuurregeling	Elektro-mechanisch	Onderwarmte - vermogen	1700 W	Bovenwarmte - vermogen	1200 W	Grill - vermogen	1700 W	Grote vlakgrill - vermogen	2900 W

Circulatie - vermogen	2 x 1550 W
Grill type	Elektrisch

Opties primaire oven

Timer	Ja	Minimum temperatuur	50 °C
Geluidssignaal einde kooktijd	Ja	Maximum temperatuur	260 °C

Meegeleverde accessoires primaire oven en kookplaat

Ovenrooster met stop	1	Bakplaat (20 mm)	1
-----------------------------	---	-------------------------	---

Elektrische aansluiting

Nominale aansluitwaarde	3200 W	Testkabel	Ja
Stroom	14 A	Frequentie	50/60 Hz
Spanning	220-240 V	Connection box	3 polig
Electric cable	Not included	Stekker	Nee

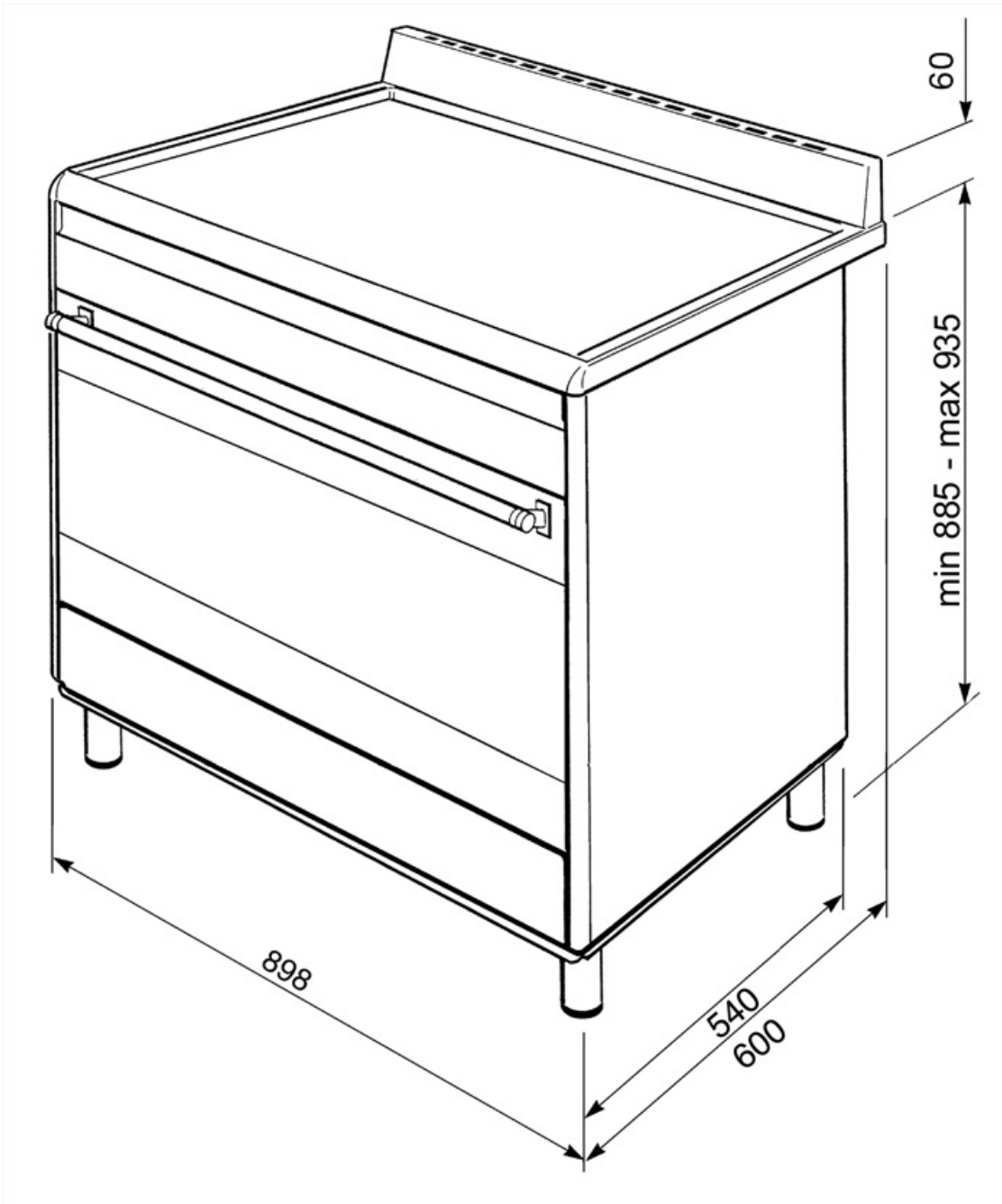

Compatible Accessories

AIRFRY9

Air fryer rack AIRFRY . Ideal for recreating traditional frying in the oven, but with fewer calories and less fat. It allows you to cook quickly and simply dishes such as French fries, fried vegetables and fish, ensuring perfect browning and crispiness.



BBQ9

teflon-coated aluminum grid for 90 cm cavity



BN940

Enamelled tray 90 cm, 40 mm deep



GTT

Volledig uitschuifbare telescopische rails (1 niveau) voor traditionele ovens (SF-).



KIT90X9-1

Splashback, stainless steel, 90cm, for Concerto cookers with single MF or gas oven



KITH95

Height extension feet (950mm), stainless steel, suitable for Concerto cookers (911-966mm)



PALPZ

Pizzapallet inox met plooibaar handvat, 315x325 mm



SMOLD

Set van 7 siliconen vormen voor ijsjes, pralines, ijsblokjes of porties. -60°C tot 230°C.

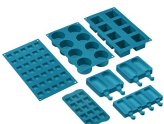

AL90X9

Upstand suitable for 90cm Concert cookers with gas hob and MF oven



BN920

Enamelled tray 90cm cavity, 20mm deep



GTP

Partially extractable telescopic guides (1 level), suitable for traditional ovens. Made in stainless steel, they guarantee stability and facilitate the smooth extraction of the trays.



KIT600SNL-9

Cover strip for hob back side, depth 60mm, suitable for 90cm single oven Concerto cookers



KITH900BG91

Plinth, 90cm, three sides, black, suitable for Concerto cookers single or double cavities, high 900 mm



KITPDQ

Height reduction feet (850mm), stainless steel, for Concerto cookers (850-881mm)



























SFLK1

Child lock



Symbols glossary

 <p>Heavy duty cast iron pan stands: for maximum stability and strength.</p>	 <p>Energy efficiency class A</p>
 <p>Installation in column: Installation in column.</p>	 <p>Knobs control</p>
 <p>Air cooling system: to ensure a safe surface temperatures.</p>	 <p>DIGI screen display + bedieningsknoppen</p>
 <p>Triple glazed doors: Number of glazed doors.</p>	 <p>Ever Clean Enamel: Ever Clean enamel is applied electrostatically, corner to corner and edge to edge to prevent cracking or cracks over time. It is a particular pyrolytic enamel, resistant to acids which, in addition to being pleasantly bright, promotes greater cleaning of the oven walls, thanks to its lower porosity. It is baked at over 850 °C and slowly polymerized at a scientifically determined rate to ensure uniform depth and strength. Ever Clean enamel creates an impeccable finish both on the inside of the oven and on the trays, making the surfaces of the oven incredibly easy to maintain over time as it reduces the adhesion of fat during cooking.</p>
 <p>Circogas: In gasovens verdeelt de ventilator de warmte snel en gelijkmatig over de ovenruimte, waardoor smaakoverdracht wordt vermeden bij het tegelijkertijd bereiden van een aantal verschillende gerechten. In elektrische ovens voltooit deze combinatie het koken van voedsel dat aan de oppervlakte klaar is, maar dat van binnen meer moet worden gekookt, zonder verder bruin te worden.</p>	 <p>Ventilator met bovenste en onderste elementen: De elementen in combinatie met de ventilator zijn bedoeld om een meer gelijkmatige warmte te bieden, een methode die vergelijkbaar is met conventioneel koken, dus voorverwarmen is vereist. Het meest geschikt voor items die langzaam koken vereisen.</p>
 <p>Alleen boven- en onder element: een traditionele kookmethode die het meest geschikt is voor losse items in het midden van de oven. de bovenkant van de oven zal altijd het heetst zijn. Ideaal voor gebraden vlees, fruitcake, brood etc.</p>	 <p>Circulaire: De combinatie van de ventilator en het ronde element eromheen zorgt voor een hete lucht kookmethode. Dit biedt vele voordelen, waaronder geen voorverwarmen als de kooktijd meer dan 20 minuten bedraagt, geen smaakoverdracht bij het gelijktijdig bereiden van verschillende soorten voedsel, minder energie en kortere kooktijden. Geschikt voor alle soorten voedsel.</p>
 <p>De combinatie van de grill, de ventilator en onderwarmte is interessant voor het bereiden van kleine hoeveelheden.</p>	 <p>Grill: Very intense heat coming only from above from a double heating element. The fan is not active. Provides excellent grilling and gratinating results. Used at the end of cooking, it gives a uniform browning to dishes.</p>
 <p>Half grill: For rapid cooking and browning of foods. Best results can be obtained by using the top shelf for small items, the lower shelves for larger ones, such as chops or sausages. For half grill heat is generated only at the centre of the element, so is ideal for smaller quantities.</p>	 <p>Fan grill: very intense heat coming only from above from a double heating element. The fan is active. It allows the optimal grilling of thickest meats. Ideal for large cuts of meat.</p>

-
- | | |
|---|---|
|  All glass inner door: All glass inner door, a single flat surface which is simple to keep clean. |  The inner door glass: can be removed with a few quick movements for cleaning. |
|  Side lights: Two opposing side lights increase visibility inside the oven. |  Automatic opening: some models have Automatic opening door when the cycle is finished which is a perfect solution for handle-less kitchen units as no handle is needed. For safety reasons, the door locks automatically when the machine is in use to avoid it being opened inadvertently. |
|  The oven cavity has 5 different cooking levels. |  Ultra rapid burners: Powerful ultra rapid burners offer up to 5kw of power. |
|  Vapor Clean: a simple cleaning function using steam to loosen deposits in the oven cavity. |  The capacity indicates the amount of usable space in the oven cavity in litres. |