

BG93GMBL

Cooker size	90x60 cm
N.º de cavidades com rótulo energético	2
Fonte de calor da cavidade	ELECTRICITY
Hob type	Gas
Tipo de forno principal	Thermo-ventilated
Type of second oven	Thermo-ventilated
Sistema de limpeza no forno principal	No
EAN code	8017709345907
Energy efficiency class	A
Energy efficiency class, second cavity	B



Aesthetics



Aesthetic	Classica	Type of control setting	Control knobs
Serie	Mestre	Control knobs	Smeg Master Glass
Design	Standard	Controls colour	Black
Colour	Black	No. of controls	8
Acabamento	Glossy black	Cor da serigrafia	Serigrafia em prateado
Command panel finish	Enamelled metal	Display	Touch
Logo	Logotipo aplicado	Door	Full glass
Posição do logotipo	Logotipo no painel de comandos	Glass type	Black
Upstand	No	Handle	Smeg Classic
Cor da placa	Esmalte preto	Handle Colour	Brushed stainless steel
Type of pan stands	Cast Iron	Feet	Black

Programs / Functions

No. of cooking functions	1
Traditional cooking functions	

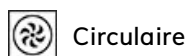

Recipes	No
Cleaning functions	No

Programs / Functions Auxiliary Oven

Funções de cozedura cavidade 2	1
Defrost	No
Vapor Clean	No









Programs / Functions Third Oven

No. of functions third oven	1
Oven light	No
Half grill	No
Full grill	

Hob technical features

			
Total no. of cook zones 5			
Front left - Gas - Rapid - 2.90 kW			
Rear left - Gas - Semi Rapid - 1.80 kW			
Central - Gas - UR - 4.00 kW			
Rear right - Gas - Semi Rapid - 1.80 kW			
Front right - Gas - AUX - 1.00 kW			
Type of gas burners	Standard	Gas safety valves	Yes
Automatic electronic ignition	Yes	Burner caps	Matt black enamelled

Main Oven Technical Features

       			
No. of lights	1	Removable door	Yes
Fan number	1	Full glass inner door	Yes
Net volume of the cavity	61 l	Removable inner door	Yes
Gross volume, 1st cavity	70 l	Total no. of door glasses	3
Cavity material	Ever Clean enamel	No. of thermo-reflective door glasses	1
No. of shelves	4	Safety Thermostat	Yes
Type of shelves	Metal racks	Cooling system	Tangential
Roof Liner	No	Usable cavity space dimensions (HxWxD)	316x460x412 mm
Light type	Halogen	Temperature control	Electro-mechanical
Light Power	40 W	Circular heating element - Power	2000 W
Cooking time setting	Start and Stop	Tilting grill	No
Door opening	Side opening		

Options Main Oven

Timer	Yes	Minimum Temperature	50 °C
--------------	-----	----------------------------	-------

End of cooking acoustic alarm Yes

Maximum temperature 245 °C

Second Oven Technical Features



Fan number 1
 Net volume of the second cavity 62 l
 Gross volume, 2nd cavity 69 l
 Cavity material Ever Clean enamel
 No. of shelves 9
 Type of shelves Metal racks
 Roof Liner No
 Door opening Side opening
 Removable door Yes
 Full glass inner door Yes

Removable inner door No
 No. total door glasses 2
 No. thermo-reflective door glasses 1
 Safety Thermostat Yes
 Cooling system Tangential
 Usable cavity space dimensions (HxWxD) 605x275x370 mm
 Temperature control Electro-mechanical
 Potência da resistência circular 2500 W
 Tilting grill No

Options Auxiliary Oven

Timer No
 End of cooking acoustic alarm No

Minimum Temperature 50 °C
 Maximum temperature 245 °C

Third Oven Technical Features



Net volume, 3rd cavity 35 l
 Gross volume, 3rd cavity 41 l
 Cavity material Ever Clean enamel
 No. of shelves 2
 Type of shelves Metal racks
 Roof Liner No
 Door opening Flap down
 Removable door Yes
 Full glass inner door Yes
 Removable inner door Yes

No. total door glasses 3
 No. of thermo-reflective door glasses 1
 Safety Thermostat Yes
 Cooling system Tangential
 Usable cavity space dimensions (HxWxD) 169x440x443 mm
 Temperature control Electro-mechanical
 Large grill - Power 2700 W
 Grill type Electric
 Tilting grill Yes

Options Third Oven

Timer No
 End of cooking acoustic alarm No

Minimum Temperature 50 °C
 Maximum temperature 260 °C

Accessories included for Main Oven & Hob

Rack com batente traseiro e lateral	1	40mm deep tray	1
-------------------------------------	---	----------------	---

Accessories included for Secondary Oven

Oven grid with back stop	3
--------------------------	---

Electrical Connection

Plug	No	Electric cable	Installed, Single phase
Electrical connection rating	7600 W	Type of electric cable	Double and Three Phase
Current	33 A	Frequency	50/60 Hz
Voltage	220-240 V	Bloco de terminais	5 polos
Voltage 2 (V)	380-415 V		

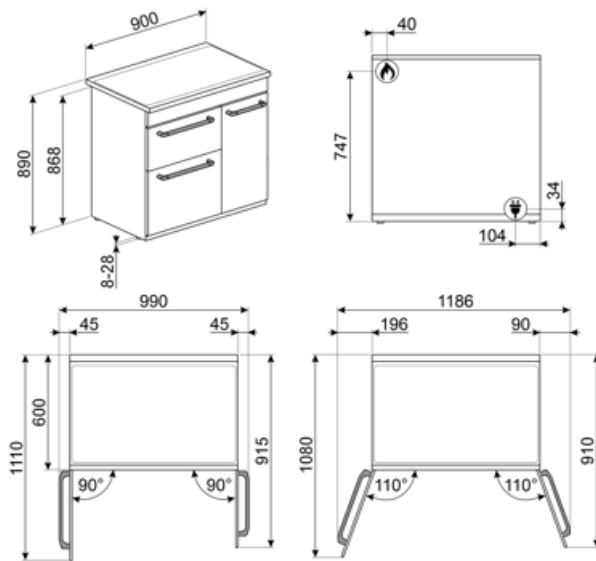

Compatible Accessories

AIRFRY

Air fryer rack AIRFRY . Ideal for recreating traditional frying in the oven, but with fewer calories and less fat. It allows you to cook quickly and simply dishes such as French fries, fried vegetables and fish, ensuring perfect browning and crispiness.



BG6090-1

Placa grelhadora de ferro fundido adequada para fogões Concerto



BN640

Tabuleiro esmaltado, 40mm de profundidade



GRM

Suporte moka para placas a gás



GTT

** Guias telescópicas totalmente extraíveis (1 nível)** Extração: 433 mm
Material: Aço inoxidável AISI 430 polido



BBQ

Double sided plate BBQ. Suitable for recreating succulent and crispy dishes in the oven with the typical taste of grilled cooking. The ribbed side is particularly suitable for meats and cheeses. The smooth side for fish, seafood and vegetables.



BN620-1

Tabuleiro esmaltado, 20mm de profundidade



BNP608T

Bandeja revestida de teflon, 8mm de profundidade, a ser colocada na grade



GTP

** Guias telescópicas parcialmente extraíveis (1 nível)** Extração: 300 mm
Material: Aço inoxidável AISI 430 polido



KIT90N9

Painel anti-salpicos 90 cm, preto, para fogões BU & BM



KITH93

Kit extensão de altura (950 mm), adequado para fogões TR93



SFLK1

Bloqueio para crianças



PALPZ

Pá para pizza com alça dobrável largura: 315mm comprimento : 325mm



SMOLD

Conjunto de 7 moldes de silicone para sorvetes, gelados, pralinés, cubos de gelo ou para porção de alimentos. Utilizável de -60°C a +230°C

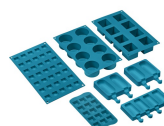

STONE

Pedra refratária retangular Ideal para cozinhar pizzas com os mesmos resultados de um forno típico a lenha. Também pode ser usado para assar pães, focaccias e outras receitas como tortas, flans ou biscoitos Dimensões:L42 x H1,8 x P37,5 cm.



























WOKGHU

Suporte de ferro fundido para WOK



Symbols glossary

 <p>Suportes de ferro fundido para serviço pesado: para máxima estabilidade e resistência.</p>	 <p>R: Desempenho de secagem do produto, medido de A++ a D/G, dependendo da família de produtos</p>
 <p>Instalação em coluna: Instalação em coluna</p>	 <p>Controle dos botões</p>
 <p>Sistema de arrefecimento a ar: para garantir temperaturas de superfície seguras.</p>	 <p>...</p>
 <p>B: Classificação de energia do produto, medida de A+++ a D/G, dependendo da família de produtos.</p>	 <p>Portas de vidros duplos: Número de portas envidraçadas.</p>
 <p>Portas envidraçadas triplas: Número de portas envidraçadas.</p>	 <p>Interior esmaltado: O interior em esmalte de todos os fornos Smeg tem um revestimento antiácido especial que ajuda a manter o interior limpo, reduzindo a quantidade de gordura de cozimento aderente a ele.</p>
 <p>Circulaire: A combinação do ventilador e do elemento circular em torno dele dá um método de cozimento de ar quente. Isso oferece muitos benefícios, incluindo nenhum pré-aquecimento se o tempo de cozimento for superior a 20 minutos, nenhuma transferência de sabor ao cozinhar alimentos diferentes ao mesmo tempo, menos energia e tempos de cozimento mais curtos. Bom para todos os tipos de alimentos.</p>	 <p>Elemento de grelha O uso de grelha dá excelentes resultados ao cozinhar carne de porções médias e pequenas, especialmente quando combinada com uma rotisseria (sempre que possível). Também é ideal para cozinhar salsichas e bacon.</p>
 <p>Toda a porta interna de vidro: Toda a porta interna de vidro, uma única superfície plana que é simples de manter limpa.</p>	 <p>O vidro interior da porta: pode ser removido com alguns movimentos rápidos para limpeza.</p>
 <p>Luzes laterais: Duas luzes laterais opostas aumentam a visibilidade dentro do forno.</p>	 <p>O compartimento do forno tem 2 níveis de cozimento diferentes.</p>
 <p>O compartimento do forno tem 4 níveis de cozimento diferentes.</p>	 <p>O compartimento do forno tem 9 níveis de cozimento diferentes.</p>
 <p>Comando eletrônico. Permite manter a temperatura no interior do forno com a precisão de 2-3 ° C. Isso permite cozinhar refeições que são muito sensíveis a mudanças de temperatura, como por ex. bolos, suflês, pudins.</p>	 <p>Grelha basculante: a grelha basculante pode ser facilmente desengatada para mover o elemento de aquecimento e limpar o tejadilho do aparelho em um simples passo.</p>
 <p>Queimadores ultrarrápidos: Queimadores ultrarrápidos potentes oferecem até 5kw de potência.</p>	 <p>A capacidade indica a quantidade de espaço útil no compartimento do forno em litros.</p>
 <p>A capacidade indica a quantidade de espaço útil no compartimento do forno em litros.</p>	 <p>A capacidade indica a quantidade de espaço útil no compartimento do forno em litros.</p>

Benefit (TT)

Gas hob

Gas provides permanent control of the heat source and the temperature change is immediate
Equipped with a thermocouple, the gas supply is cut off if the flame is extinguished for greater safety.

Ever Clean Enamel

Easy oven cleaning thanks to special pyrolytic enamel

Touch control

Easy and intuitive timer setting with a single touch

True-convection

The best cooking performances guaranteed by ventilated circular flow
Multiple fans and heating elements guarantee the perfect aerodynamic heat flow, allowing homogeneous and quicker cooking inside the cavity.

Multilevel cooking

Several cooking levels allow maximum flexibility of use

Multilevel halogen light

Internal halogen lighting on different levels guarantees excellent visibility

Removable inner glass

Internal door glasses are easily removable for complete cleaning

Tangential cooling

New cooling system with tangential fan and airflow from the door to the splashback

Isothermic Cavity

The best cooking performance at the highest energy efficiency

BBQ (optional accessory)

Barbeque cooking directly in the oven with the double-sided grill (BBQ optional accessory)

Pizza stone (optional accessory)

Baking with refractory stone for soft and crispy pizza and yeast products (STONE optional accessory)

Cold door

During any function, the external door glass is cold, avoiding any risk of burns

AirFry (AIRFRY optional accessory)

Lighter and tastier food thanks to airfry basket (optional accessory)

Adjustable height

Cooker top flushed with the working area thanks to adjustable feet

Single turbine

The oven has a fan equipped with a circular heating element allowing cooking with rotating heat