

# C4172E



Product Family	Refrigerator
Installation	Built-in
Category	Bottom Mount
Built-in niche	178
Reference width	Until 60
Reference height	160 - 200
Cooling type	Static
Defrost	Automatic for refrigerator, manual for freezer
Hinge type	Sliding
Hinge position	Right
Reversible door	Yes
EAN code	8017709323905



## Aesthetics



Aesthetic	Universal	Cor do perfil das prateleiras da porta	White
Colour	White	Cor do perfil da prateleira de vidro	White
Material	Metal sheet	Display	LED
Handle kit to be ordered separately	No	Mostrar porções	Interno (cela frigo)
Side material	Steel	Dispenser	No
Side colour	White	Water Filter	No
Logotipo	Logotipo serigrafado		

## Refrigerator compartment features



No. of adjustable shelves	4	Type of crisper/vegetable drawers cover	Glass
Number of fruit and vegetables drawers	2	Nº de lâmpadas	1
Type of adjustable shelves	Glass	Life Plus zone-0°C	No
Type of crisper/vegetable drawers cover	Standard	Compartimento baixa temperatura	No
Crisper Cover	Yes	Internal light in fridge	Yes
Bottle shelf	No	Type of internal light (fridge)	LED

## Refrigerator Inner Door

<b>No. of door shelves with transparent cover</b>	1	<b>No. of bottle shelves</b>	1
<b>Number of adjustable door shelves</b>	2	<b>Bottle shelves with wire support</b>	No
<b>Adjustable door shelves with wire support</b>	No		

## Other Refrigerator features

<b>Accessories</b>	Egg tray	<b>Fan</b>	No
<b>Natural Plus Blu Light</b>	No	<b>Ionizer</b>	No
<b>MultiFlow</b>	No		

## Freezer compartment features

<b>Number of drawers</b>	3	<b>Type of internal light (freezer)</b>	No
<b>Internal light in freezer</b>	No		

## Freezer Inner Door

<b>Pizza box</b>	No
------------------	----

## Other Freezer features

<b>Accessories</b>	1 ice box	<b>Fast freezing compartment</b>	No
<b>Manual ice maker</b>	No	<b>Ice tray shelf</b>	No

## Other technical features



<b>Functions display</b>	Fast freezing, Temperature alarm
<b>MultiZone</b>	No
<b>Fast freezing button</b>	Yes
<b>Power on lamp</b>	No
<b>Temperature alarm lamp</b>	No
<b>Door open alarm</b>	Yes
<b>Temperature Alarm</b>	Acoustic and visual
<b>Type of temperature control</b>	Electronic
<b>No. of compressors</b>	1
<b>Refrigerant gas type</b>	R600a
<b>Type of compressor</b>	Standard
<b>Espuma expansiva de isolamento</b>	Ciclopentano

## Etiqueta de Desempenho / Energia - Reg. 2019







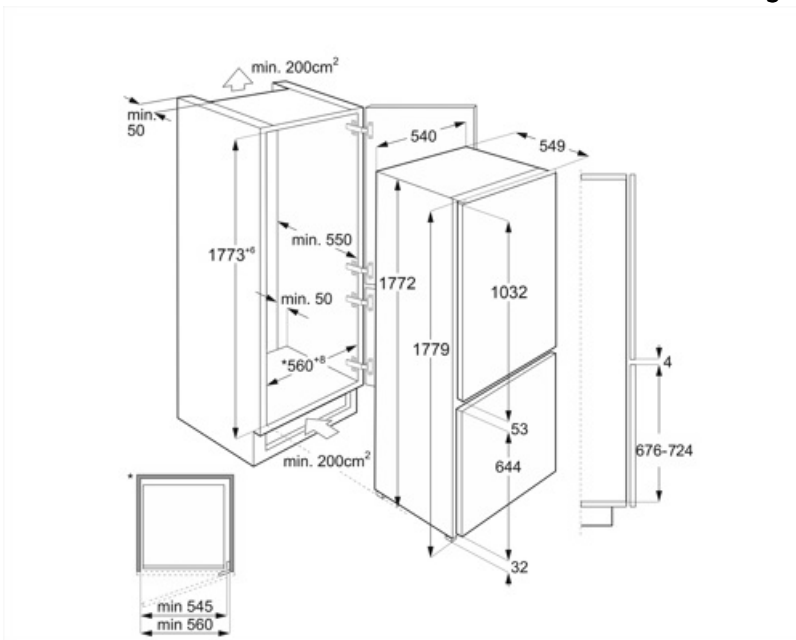

<b>Consumo de energia anual</b>	219 kWh/a	<b>Airborne acoustical noise emissions</b>	34 dB(A) re 1 pW
<b>Classe de eficiência energética</b>	E	<b>Autonomia de conservação sem energia elétrica</b>	11.50 h
<b>Classe de emissão de ruído acústico aerotransportado</b>	B	<b>4 estrelas - Capacidade de congelamento</b>	3.3 Kg/24h
<b>Volume líquido total</b>	271 l	<b>Classe climática</b>	SN, N, ST, T
<b>Soma dos volumes do(s) compartimento(s) congelado(s)</b>	73 l	<b>EI</b>	100 %
<b>Soma dos volumes do(s) compartimento(s) refrigerado(s) e do(s) compartimento(s) não congelado(s)</b>	198 l		

## Electrical Connection

<b>Plug</b>	(F;E) Schuko	<b>Voltage (V)</b>	230-240 V
<b>Electrical connection rating</b>	140 W	<b>Frequency (Hz)</b>	50 Hz
<b>Current</b>	1,1 A	<b>Power supply cable length</b>	240 cm



## Symbols glossary

- |  |  |
|--|--|
|  <p>O sistema de descongelamento automático funciona descongelando automaticamente em intervalos regulares, eliminando a necessidade de descongelar completamente.</p> |  <p>Display LED: para mostrar os programas, funções e opções selecionadas e o tempo até ao final do ciclo.</p>                    |
|  <p>CONGELAMENTO RÁPIDO: A função de congelamento rápido reduz a temperatura do compartimento quando ativado algumas horas antes do uso.</p>                           |  <p>Iluminação interior LED: é uma forma mais eficiente em termos energéticos e duradoura de iluminar o interior do aparelho.</p> |
|  <p>Nicho incorporado</p>  |  <p>Classe de eficiência energética E.</p>  |

---

## Benefit (TT)

---

### **Refrigerant gas R600a**

Environmentally friendly R600a refrigerant gas contributes to rapid cooling with lower energy consumption

### **Refrigerator Internal lighting**

Interior lighting for perfect visibility of shelves in the refrigerator compartment

### **Fruit and vegetable drawer**

The fruit and vegetable drawer ensures the best storage conditions for fresh food, avoiding any contamination

### **Internal display**

Internal display for targeted temperature control and a clean, minimalist design