

# C41941F



<b>Product Family</b>	Refrigerator
<b>Installation</b>	Built-in
<b>Category</b>	Bottom Mount
<b>Built-in niche</b>	190-195
<b>Reference width</b>	Until 60
<b>Reference height</b>	160 - 200
<b>Cooling type</b>	Fan assisted refrigerator, static freezer
<b>Defrost</b>	Automatic for refrigerator, manual for freezer
<b>Hinge type</b>	Sliding
<b>Hinge position</b>	Right
<b>Reversible door</b>	Yes
<b>EAN code</b>	8017709295400



## Aesthetics



<b>Aesthetic</b>	Universal	<b>Logotipo</b>	Logotipo serigrafado
<b>Colour</b>	White	<b>Cor do perfil das prateleiras da porta</b>	White
<b>Design</b>	Flat	<b>Cor do perfil das gavetas</b>	White
<b>Material</b>	Metal sheet	<b>Cor do perfil da prateleira de vidro</b>	White
<b>Handle kit to be ordered separately</b>	No	<b>Display</b>	LED
<b>Handle type</b>	Fixed	<b>Mostrar porções</b>	Interno (no Topo)
<b>Logo colour</b>	Black	<b>Dispenser</b>	No
<b>Side material</b>	Steel	<b>Water Filter</b>	No
<b>Side colour</b>	White	<b>HomeBar</b>	No

## Refrigerator compartment features



<b>No. of adjustable shelves</b>	4	<b>Type of crisper/vegetable drawers cover</b>	Glass
<b>Number of fruit and vegetables drawers</b>	1	<b>Life Plus zone-0°C</b>	No
<b>Type of adjustable shelves</b>	Glass	<b>Compartimento baixa temperatura</b>	No
<b>Type of crisper/vegetable drawers cover</b>	Standard	<b>Internal light in fridge</b>	Yes
<b>Crisper Cover</b>	Yes	<b>Type of internal light (fridge)</b>	LED

Bottle shelf No

## Refrigerator Inner Door

No. of door shelves with transparent cover	1	No. of bottle shelves	1
Number of adjustable door shelves	1	Bottle shelves with wire support	Yes
Adjustable door shelves with wire support	Yes		

## Other Refrigerator features



Accessories	Kit listeria, Egg tray	Fan	Yes
Natural Plus Blu Light	No	Ionizer	No
MultiFlow	No		

## Freezer compartment features

Number of drawers	3	Type of internal light (freezer)	No
Internal light in freezer	No	Type of shelves	Glass

## Other Freezer features



Accessories	1 ice box	Fast freezing compartment	Yes
Manual ice maker	No	Ice tray shelf	No
Ice maker	No		

## Other technical features



Functions display	Holiday, Fast freezing, Fast cooling
MultiZone	No
Fast freezing button	No
Power on lamp	No
Temperature alarm lamp	No
Door open alarm	No
Temperature Alarm	No
Antibacterial Gasket	Yes
Type of temperature control	Electronic
No. of compressors	1
Refrigerant gas type	R600a
Type of compressor	Standard

Refrigerant Quantity (gr)	58 g
Espuma expansiva de isolamento	Ciclopentano

## Etiqueta de Desempenho / Energia - Reg. 2019







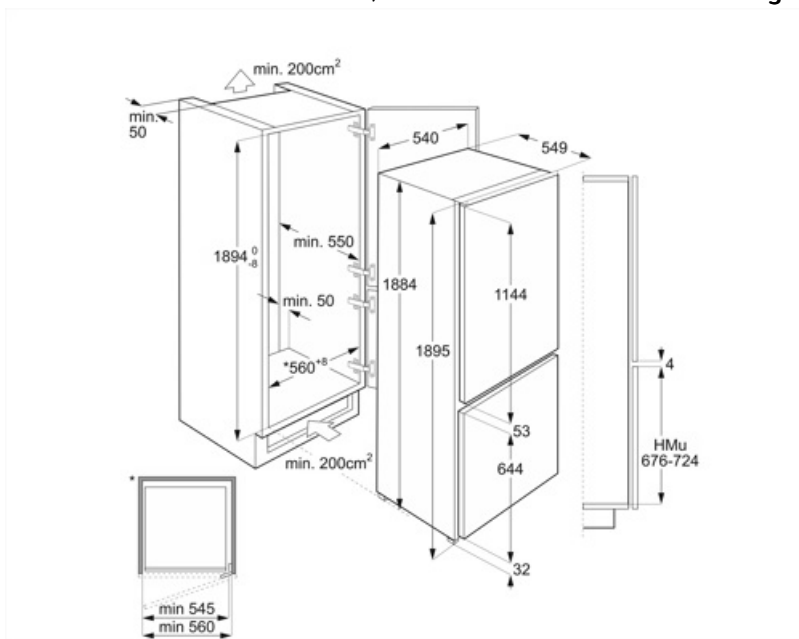



			
Consumo de energia anual	272 kWh/a	Airborne acoustical noise emissions	35 dB(A) re 1 pW
Classe de eficiência energética	F	Autonomia de conservação sem energia elétrica	11.50 h
Classe de emissão de ruído acústico aerotransportado	B	4 estrelas - Capacidade de congelamento	4.5 Kg/24h
Volume líquido total	285 l	Classe climática	SN, N, ST, T
Soma dos volumes do(s) compartimento(s) congelado(s)	72 l	EEl	125 %
Soma dos volumes do(s) compartimento(s) refrigerado(s) e do(s) compartimento(s) não congelado(s)	213 l		

## Electrical Connection

Plug	(F;E) Schuko	Voltage (V)	230-240 V
Electrical connection rating	110 W	Frequency (Hz)	50 Hz
Current	0,7 A	Power supply cable length	240 cm



## Symbols glossary

	Compartimento de congelamento de 4 estrelas para uma melhor preservação dos alimentos.		O sistema de descongelamento automático funciona descongelando automaticamente em intervalos regulares, eliminando a necessidade de descongelar completamente.
	Tratamento antibacteriano: tratamento antibacteriano para garantir uma melhor higiene		A++: A classe de eficiência energética A++ ajuda a economizar até 20% de energia em comparação com a classe A. O desempenho máximo com consumo mínimo é garantido.
	Classe de eficiência energética F		Display LED: para mostrar os programas, funções e opções selecionadas e o tempo até ao final do ciclo.
	Ventilado: Distribuição forçada de ar frio no compartimento da geladeira, o que permite uma distribuição uniforme da temperatura dentro da geladeira.		CONGELAMENTO RÁPIDO: A função de congelamento rápido reduz a temperatura do compartimento quando ativado algumas horas antes do uso.
	Modo de economia de energia: O modo de economia de energia permite-lhe desativar a geladeira e manter o congelador a funcionar.		Iluminação interior LED: é uma forma mais eficiente em termos energéticos e duradoura de iluminar o interior do aparelho.
	Nicho incorporado		

---

## Benefit (TT)

---

### **Fan**

The fan contributes to an even distribution of air inside the refrigerator

### **Refrigerant gas R600a**

Environmentally friendly R600a refrigerant gas contributes to rapid cooling with lower energy consumption

### **Climate class**

Climatic class SN-T makes the appliance suitable for working at room temperature between 10 °C and 43 °C (50 °F ~ 109 °F)

### **Refrigerator Internal lighting**

Interior lighting for perfect visibility of shelves in the refrigerator compartment

### **Fruit and vegetable drawer**

The fruit and vegetable drawer ensures the best storage conditions for fresh food, avoiding any contamination

### **Internal display**

Internal display for targeted temperature control and a clean, minimalist design