

C6IMBLT2

Cooker size	60x60 cm
N. of cavities with energy label	1
Cavity heat source	ELECTRICITY
Hob type	Induction
Type of main oven	Fan assisted
Cleaning system main oven	Vapor Clean
EAN code	8017709345952
Energy efficiency class	A



Aesthetics



Design	Standard	Type of control knobs	Smeg Classic
Command panel finish	Enamelled metal	Controls colour	Stainless steel
Aesthetic	Classica	No. of controls	2
Logo	Embossed	Serigraphy colour	Black
Colour	Black	Display name	DigiScreen
Logo position	Facia below the oven	Door	Full glass
Finishing	Glossy	Glass type	Eclipse
Series	Concerto	Handle	Smeg Classic
Hob colour	Stainless steel	Handle Colour	Brushed stainless steel
Type of control setting hob	Digi Touch	Feet color	Black
Hob LED colours	Red		

Programs / Functions main oven

No. of cooking functions 6
Traditional cooking functions



Static



Fan assisted



Eco



Large grill



Fan grill (large)



Fan assisted base

Hob options



Control lock	Yes	Limited Power Consumption Mode	Yes
End cooking timer	4	Limited Power Consumption Mode in W	1000, 1600, 2200, 2800, 3500, 6000, 7200 W
Minute minder	1		

Hob technical features



Total no. of cook zones 4			
Front left - Induction - single - 1.60 kW - Booster 2.10 kW - Ø 21.0 cm			
Rear left - Induction - single - 1.20 kW - Booster 1.60 kW - Ø 15.0 cm			
Rear right - Induction - single - 1.60 kW - Booster 2.10 kW - Ø 21.0 cm			
Front right - Induction - single - 1.20 kW - Booster 1.60 kW - Ø 15.0 cm			
No. of cooking zones with Booster	4	Minimum pan diameter indication	Yes
Automatic switch off when overheat	Yes	Selected zone indicator	Yes
Automatic pan detection	Yes	Residual heat indicator	Yes

Main Oven Technical Features



No. of lights	1	Removable inner door	Yes
Fan number	1	Total no. of door glasses	3
Net volume of the cavity	70 l	No. of thermo-reflective door glasses	2
Gross volume, 1st cavity	79 l	Safety Thermostat	Yes
Cavity material	Ever Clean enamel	Cooling system	Tangential
No. of shelves	5	Usable cavity space dimensions (HxWxD)	360X460X425 mm
Type of shelves	Metal racks	Temperature control	Electro-mechanical
Light type	Halogen	Lower heating element power	1200 W
Light Power	40 W	Upper heating element - Power	1000 W
Cooking time setting	Stop	Grill element	1700 W
Door opening	Flap down	Large grill - Power	2700 W
Removable door	Yes	Grill type	Electric
Full glass inner door	Yes		

Options Main Oven

Timer	Yes	Minimum Temperature	50 °C
End of cooking acoustic alarm	Yes	Maximum temperature	260 °C

Accessories included for Main Oven & Hob

Rack with back and side stop 1

40mm deep tray

1

Electrical Connection

Electrical connection rating	10000 W	Additional connection modalities	Double and Three Phase
Current	44 A	Frequency	50/60 Hz
Voltage	220-240 V	Terminal block	5 poles
Voltage 2 (V)	380-415 V	Plug	Not present
Electric cable	Installed, Single phase		

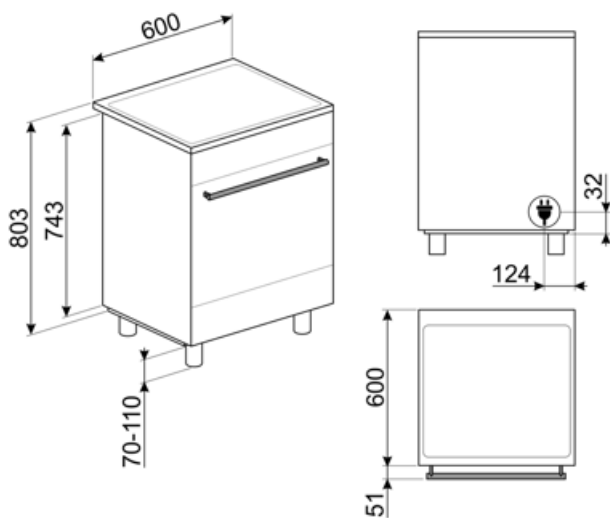

Compatible Accessories



BN620-1

Enamelled tray suitable for 45 cm and 60 cm ovens. Depth 20 mm. Perfect for a wide range of savoury and sweet baking.



BNP608T

Teflon-coated tray, 8 mm depth, to be placed on the grid



GTT

Totally extractable telescopic guides (1 level), suitable for traditional ovens. Made in stainless steel, they guarantee stability and facilitate the smooth extraction of the trays.



KITP60X9

Splashback, stainless steel, suitable for 60X60cm Concerto cookers with pyro and MF oven



PALPZ

Pizza shovel with folding handle. Dimensions L31.5 x H32.5 cm. Easy and convenient to use and store. Perfect for serving pizza, bread and savory pastries in a safe and professional way.



SFLK1

Child lock



STONE

Rectangular refractory stone Ideal for cooking pizzas with the same results as a typical wood-fired oven. Can also be used for baking bread, focaccias and other recipes such as pies, flans or biscuits Dimensions:L42 x H1,8 x P37,5 cm.



BN640

Enamelled tray suitable for 45cm and 60cm ovens. Depth 540 mm. Perfect for cooking and roasting meat and fish in sauces. Also ideal for experimenting with lighter and crunchy side dishes



GTP

Partially extractable telescopic guides (1 level), suitable for traditional ovens. Made in stainless steel, they guarantee stability and facilitate the smooth extraction of the trays.



KITH95

Height extension feet (950mm), stainless steel, suitable for Concerto cookers (911-966mm)



KITPDQ

Height reduction feet (850mm), stainless steel, for Concerto cookers (850-881mm)



SCRIP

Non-scratch hob scraper - suitable for induction and ceramic hobs

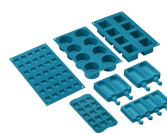

SMOLD

Set of 7 silicone moulds for ice creams, ice lollies, pralines, ice cubes or to portion food. Usable from -60°C to +230°C

Alternative products



C6IMMBT2

















Colour: Matt Black













C6IMXT2

Colour: Stainless steel

Symbols glossary

 Energy efficiency class A	 Power booster: option allows the zone to work at full power when very intense cooking is necessary.
 Child lock: some models are fitted with a device to lock the programme/cycle so it cannot be accidentally changed.	 Installation in column: Installation in column.
 Air cooling system: to ensure a safe surface temperatures.	 Triple glazed doors: Number of glazed doors.
 ECO-logic: option allows you to restrict the power limit of the appliance real energy saving.	 Ever Clean Enamel: Ever Clean enamel is applied electrostatically, corner to corner and edge to edge to prevent cracking or cracks over time. It is a particular pyrolytic enamel, resistant to acids which, in addition to being pleasantly bright, promotes greater cleaning of the oven walls, thanks to its lower porosity. It is baked at over 850 °C and slowly polymerized at a scientifically determined rate to ensure uniform depth and strength. Ever Clean enamel creates an impeccable finish both on the inside of the oven and on the trays, making the surfaces of the oven incredibly easy to maintain over time as it reduces the adhesion of fat during cooking.
 Fan assisted base: the mix of fan and lower heating element alone allows to finish cooking foods already cooked on the surface but not internally more quickly. This system is recommended to finish cooking foods that are already well cooked on the surface, but not internally, which therefore require a moderate higher heat. Ideal for any type of food.	 Fan assisted: Intense and homogeneous traditional cooking, also suitable for complex recipes. The fan is active and the heat comes from below and from above at the same time. Ventilated cooking ensures a faster and more homogeneous result, leaving fragrant foods outside and moister inside. Ideal for baked pasta, biscuits, roasts and cobblers.
 Static: Traditional cooking suitable for the preparation of one dish at a time. The fan is not active and the heat comes from below and from above at the same time. Static cooking is slower and more delicate, ideal in order to get well cooked and dry dishes even inside. Ideal for cooking all types of roasts, fatty meats, bread, filled cakes.	 ECO: low energy consumption cooking: this function is particularly suitable for cooking on a single shelf with low energy consumption. It is recommended for all types of food except those that can generate a lot of moisture (for example vegetables). To achieve maximum energy savings and reduce time, it is recommended to put the food in the oven without preheating the cooking compartment.
 Grill: Very intense heat coming only from above from a double heating element. The fan is not active. Provides excellent grilling and gratinating results. Used at the end of cooking, it gives a uniform browning to dishes.	 Fan grill: very intense heat coming only from above from a double heating element. The fan is active. It allows the optimal grilling of thickest meats. Ideal for large cuts of meat.
 Overheat protection: The safety system that automatically turns off the hob in case of overheating of the control unit.	 Induction: The work of these hobs is based on the principle of electromagnetic induction. The heat is generated directly in the bottom of the pan during its contact with the hob.

-
- | | |
|--|---|
|  All glass inner door: All glass inner door, a single flat surface which is simple to keep clean. |  The inner door glass: can be removed with a few quick movements for cleaning. |
|  Side lights: Two opposing side lights increase visibility inside the oven. |  Automatic opening: some models have Automatic opening door when the cycle is finished which is a perfect solution for handle-less kitchen units as no handle is needed. For safety reasons, the door locks automatically when the machine is in use to avoid it being opened inadvertently. |
|  Indication of residual heat: After the glass ceramic hob is switched off the residual heat indicator shows which of the heating zones still remains hot. When the temperature drops below 60 ° C, the indicator goes out. |  The oven cavity has 5 different cooking levels. |
|  Timer: All ceramic hobs have a timer which automatically ends cooking after a preset time. |  Vapor Clean: a simple cleaning function using steam to loosen deposits in the oven cavity. |
|  The capacity indicates the amount of usable space in the oven cavity in litres. |  4.3 inch display with LED technology, usability with knobs + 3 touch keys |
|  Touch control | |