

C6IMBLT2

Categorie fornuis	60x60 cm
N. of cavities with energy label	1
Cavity heat source	Elektriciteit
Type kookplaat	Inductie
Type primaire oven	Geventileerd
Reinigingsstelsel primaire oven	Vapor Clean reiniging
EAN-code	8017709345952
Energie-efficiëntieklasse	A









Design



Design	Standaard	Bedieningsknoppen	Smeg Classici
Afwerking bedieningspaneel	Gekleurd plaatstaal	Kleur bedieningsknoppen	Inox
Design	Classici	Aantal bedieningsknoppen	2
Logo	In reliëf	Kleur serigrafie	Zwart
Kleur	Zwart	Display	DigiScreen
Positie logo	Strook onder de oven	Deur	Geheel glas
Afwerking	Glanzend	Type glas	Eclipse zwart glas
Series	Concerto	Handgreep	Smeg Classici
Kleur kookplaat	Inox	Kleur handgreep	Geborsteld inox
Bediening	Digi touch multi slider	Pootjes	Zwart
Kleur LED	Rood		

Programma's / Functies

Aantal kookfuncties	6
Traditionele bereidingsfuncties	

 Statisch	 Geventileerd	 ECO
 Grote grill	 Ventilator + grote grill	 Geventileerde onderwarmte

Opties kookplaat



Kinderbeveiliging	Ja	ECO-Logic optie	Ja
Automatische uitschakeling	4	Beperkt vermogensverbruik	1000, 1600, 2200, 2800, 3500, 6000, 7200 W
Timer	1		

Technische specificaties kookplaat



Totaal aantal kookzones 4

Linksvoor - Inductie - enkel - 1.60 kW - Booster 2.10 kW - Ø 21.0 cm

Linksachter - Inductie - enkel - 1.20 kW - Booster 1.60 kW - Ø 15.0 cm

Rechtsachter - Inductie - enkel - 1.60 kW - Booster 2.10 kW - Ø 21.0 cm

Rechtsvoor - Inductie - enkel - 1.20 kW - Booster 1.60 kW - Ø 15.0 cm

Aantal kookzones met booster	4	Indicator minimaal te gebruiken diameter	Ja
Automatisch uitschakelen i.g.v. oververhitting	Ja	Indicator geselecteerde zone	Ja
Automatische aanpassing panafmeting	Ja	Indicator (lampje) restwarmte	Ja

Technische specificaties primaire oven



Aantal lampen	1	Uitneembaar glas binnendeur	Ja
Aantal ventilatoren	1	Aantal ruiten ovendeur	3
Netto volume 1e oven	70 l	Aantal thermo-reflecterende ruiten	2
Bruto volume, oven 1	79 l	Veiligheidsthermostaat	Ja
Materiaal ovenruimte	Ever Clean emaille	Koelsysteem	Mantelkoeling
Aantal kookniveaus	5	Afmetingen bruikbare interne ovenruimte (hxbxd)	360X460X425 mm
Type ovenrekken	Metalen zijsteunen	Temperatuurregeling	Elektro-mechanisch
Type licht	Halogeen	Onderwarmte - vermogen	1200 W
Vermogen lamp	40 W	Bovenwarmte - vermogen	1000 W
Opties bereidingstijdprogrammering	Eind	Grill - vermogen	1700 W
Opening deur	Neerwaarts	Grote vlakgrill - vermogen	2700 W
Uitneembare ovendeur	Ja	Grill type	Elektrisch
Volledig glazen binnendeur	Ja		

Opties primaire oven

Timer	Ja	Minimum temperatuur	50 °C
--------------	----	----------------------------	-------

Geluidssignaal einde kooktijd Ja

Maximum temperatuur 260 °C

Meegeleverde accessoires primaire oven en kookplaat

Ovenrooster met stop 1

Bakplaat (40 mm) 1

Elektrische aansluiting

Nominale aansluitwaarde	10000 W	Type stroomkabel	Double and Three Phase
Stroom	44 A	Frequentie	50/60 Hz
Spanning	220-240 V	Connection box	5 polig
Spanning 2 (V)	380-415 V	Stekker	Nee
Electric cable	Installed, Single phase		

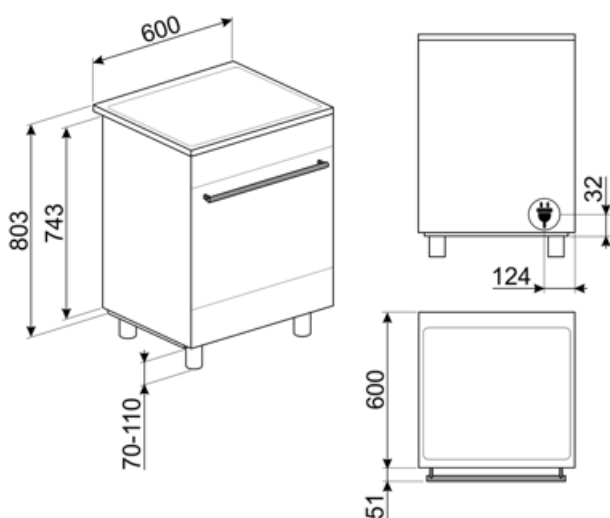

Compatible Accessories



BN620-1

Enamelled tray suitable for 45 cm and 60 cm ovens. Depth 20 mm. Perfect for a wide range of savoury and sweet baking.



BNP608T

Teflon bakplaat, 8mm diep



GTT

Volledig uitschuifbare telescopische rails (1 niveau) voor traditionele ovens (SF-).



KITP60X9

Splashback, stainless steel, suitable for 60X60cm Concerto cookers with pyro and MF oven



PALPZ

Pizzapallet inox met plooibaar handvat, 315x325 mm



SFLK1

Child lock



STONE

Rectangular refractory stone Ideal for cooking pizzas with the same results as a typical wood-fired oven. Can also be used for baking bread, focaccias and other recipes such as pies, flans or biscuits Dimensions:L42 x H1,8 x P37,5 cm.



BN640

Enamelled tray suitable for 45cm and 60cm ovens. Depth 540 mm. Perfect for cooking and roasting meat and fish in sauces. Also ideal for experimenting with lighter and crunchy side dishes



GTP

Partially extractable telescopic guides (1 level), suitable for traditional ovens. Made in stainless steel, they guarantee stability and facilitate the smooth extraction of the trays.



KITH95

Height extension feet (950mm), stainless steel, suitable for Concerto cookers (911-966mm)



KITPDQ

Height reduction feet (850mm), stainless steel, for Concerto cookers (850-881mm)



SCRIP

Schraper voor inductie- en vitrokeramische kookplaten

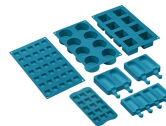

SMOLD

Set van 7 siliconen vormen voor ijsjes, pralines, ijsblokjes of porties. -60°C tot 230°C.

Alternative products



C6IMMBT2



















Kleur: Mat zwart











C6IMXT2

Kleur: Inox

Symbols glossary

 Energy efficiency class A	 Power booster: option allows the zone to work at full power when very intense cooking is necessary.
 Sommige modellen zijn voorzien van een functie om het programma/de cyclus te blokkeren zodat het niet per ongeluk kan aangepast worden.	 Installation in column: Installation in column.
 Air cooling system: to ensure a safe surface temperatures.	 Triple glazed doors: Number of glazed doors.
 ECO-logic: option allows you to restrict the power limit of the appliance real energy saving.	 Ever Clean Enamel: Ever Clean enamel is applied electrostatically, corner to corner and edge to edge to prevent cracking or cracks over time. It is a particular pyrolytic enamel, resistant to acids which, in addition to being pleasantly bright, promotes greater cleaning of the oven walls, thanks to its lower porosity. It is baked at over 850 °C and slowly polymerized at a scientifically determined rate to ensure uniform depth and strength. Ever Clean enamel creates an impeccable finish both on the inside of the oven and on the trays, making the surfaces of the oven incredibly easy to maintain over time as it reduces the adhesion of fat during cooking.
 Circogas: In gasovens verdeelt de ventilator de warmte snel en gelijkmatig over de ovenruimte, waardoor smaakoverdracht wordt vermeden bij het tegelijkertijd bereiden van een aantal verschillende gerechten. In elektrische ovens voltooit deze combinatie het koken van voedsel dat aan de oppervlakte klaar is, maar dat van binnen meer moet worden gekookt, zonder verder bruin te worden.	 Ventilator met bovenste en onderste elementen: De elementen in combinatie met de ventilator zijn bedoeld om een meer gelijkmatige warmte te bieden, een methode die vergelijkbaar is met conventioneel koken, dus voorverwarmen is vereist. Het meest geschikt voor items die langzaam koken vereisen.
 Alleen boven- en onder element: een traditionele kookmethode die het meest geschikt is voor losse items in het midden van de oven. de bovenkant van de oven zal altijd het heetst zijn. Ideaal voor gebraden vlees, fruitcake, brood etc.	 De combinatie van de grill, de ventilator en onderwarmte is interessant voor het bereiden van kleine hoeveelheden.
 Grill: Very intense heat coming only from above from a double heating element. The fan is not active. Provides excellent grilling and gratinating results. Used at the end of cooking, it gives a uniform browning to dishes.	 Fan grill: very intense heat coming only from above from a double heating element. The fan is active. It allows the optimal grilling of thickest meats. Ideal for large cuts of meat.
 Overheat protection: The safety system that automatically turns off the hob in case of overheating of the control unit.	 Induction: The work of these hobs is based on the principle of electromagnetic induction. The heat is generated directly in the bottom of the pan during its contact with the hob.
 All glass inner door: All glass inner door, a single flat surface which is simple to keep clean.	 The inner door glass: can be removed with a few quick movements for cleaning.

-
- | | |
|--|---|
|  Side lights: Two opposing side lights increase visibility inside the oven. |  Automatic opening: some models have Automatic opening door when the cycle is finished which is a perfect solution for handle-less kitchen units as no handle is needed. For safety reasons, the door locks automatically when the machine is in use to avoid it being opened inadvertently. |
|  Indication of residual heat: After the glass ceramic hob is switched off the residual heat indicator shows which of the heating zones still remains hot. When the temperature drops below 60 ° C, the indicator goes out. |  The oven cavity has 5 different cooking levels. |
|  Timer: All ceramic hobs have a timer which automatically ends cooking after a preset time. |  Vapor Clean: a simple cleaning function using steam to loosen deposits in the oven cavity. |
|  The capacity indicates the amount of usable space in the oven cavity in litres. |  DIGI screen display + bedieningsknoppen |
|  Touch control | |