

C81721E



Product Family	Refrigerator
Installation	Built-in
Category	Bottom Mount
Built-in niche	178
Reference width	Until 60
Reference height	160 - 200
Cooling type	Fan assisted
Defrost	Automatic for refrigerator, manual for freezer
Hinge type	Sliding
Hinge position	Right
Reversible door	Yes
EAN code	8017709323943



Aesthetics

			
Aesthetic	Universal	Cor do perfil das prateleiras da porta	Silver
Colour	White	Cor do perfil das gavetas	Silver
Material	Metal sheet	Cor do perfil da prateleira de vidro	Chrome
Handle kit to be ordered separately	No	Display	LED
Handle type	Fixed	Mostrar porções	Interno (cela frigo)
Side material	Steel	Dispenser	No
Side colour	White	Water Filter	No
Logotipo	Logotipo serigrafado		

Refrigerator compartment features

			
No. of adjustable shelves	4	Type of crisper/vegetable drawers cover	Glass
Number of fruit and vegetables drawers	2	Life Plus zone-0°C	No
Type of adjustable shelves	Glass	Compartimento baixa temperatura	No
Type of crisper/vegetable drawers cover	Standard	Internal light in fridge	Yes
Crisper Cover	Yes	Type of internal light (fridge)	LED
Bottle shelf	No		

Refrigerator Inner Door

No. of door shelves with transparent cover	1	No. of bottle shelves	1
Number of adjustable door shelves	2	Bottle shelves with wire support	No
Adjustable door shelves with wire support	No		

Other Refrigerator features



Accessories	Egg tray	Fan	Yes
Natural Plus Blu Light	No	Ionizer	No
MultiFlow	No		

Freezer compartment features

Number of drawers	3	Type of internal light (freezer)	No
Internal light in freezer	No		

Freezer Inner Door

Pizza box	No
-----------	----

Other Freezer features

Accessories	1 ice box	Fast freezing compartment	No
Manual ice maker	No	Ice tray shelf	No
Ice maker	No		

Other technical features



Functions display	Fast freezing, Temperature alarm
MultiZone	No
Fast freezing button	No
Power on lamp	Yes
Temperature alarm lamp	Yes
Door open alarm	Yes
Temperature Alarm	Yes
Type of temperature control	Electro-mechanical
No. of compressors	1
Refrigerant gas type	R600a

Type of compressor
Espuma expansiva de isolamento

Standard
Ciclopentano

Etiqueta de Desempenho / Energia - Reg. 2019





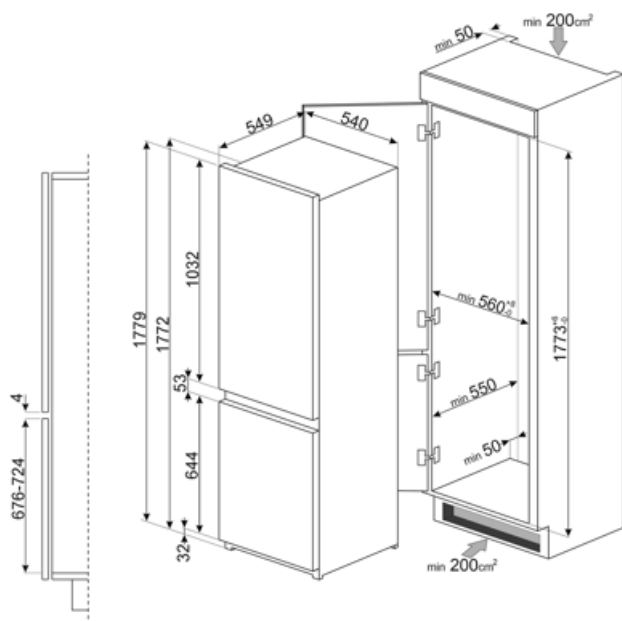

			
Consumo de energia anual	220 kWh/a	Airborne acoustical noise emissions	34 dB(A) re 1 pW
Classe de eficiência energética	E	Autonomia de conservação sem energia elétrica	11.50 h
Classe de emissão de ruído acústico aerotransportado	B	4 estrelas - Capacidade de congelamento	3.3 Kg/24h
Volume líquido total	269 l	Classe climática	SN, N, ST, T
Soma dos volumes do(s) compartimento(s) congelado(s)	73 l	EI	100 %
Soma dos volumes do(s) compartimento(s) refrigerado(s) e do(s) compartimento(s) não congelado(s)	196 l		

Electrical Connection

Plug	(F;E) Schuko	Voltage (V)	230-240 V
Electrical connection rating	140 W	Frequency (Hz)	50 Hz
Current	1,1 A	Power supply cable length	240 cm



Symbols glossary

-  O sistema de descongelamento automático funciona descongelando automaticamente em intervalos regulares, eliminando a necessidade de descongelar completamente.
-  Display LED: para mostrar os programas, funções e opções selecionadas e o tempo até ao final do ciclo.
-  CONGELAMENTO RÁPIDO: A função de congelamento rápido reduz a temperatura do compartimento quando ativado algumas horas antes do uso.
-  Nicho incorporado
-  Classe de eficiência energética E.
-  Ventilado: Distribuição forçada de ar frio no compartimento da geladeira, o que permite uma distribuição uniforme da temperatura dentro da geladeira.
-  Iluminação interior LED: é uma forma mais eficiente em termos energéticos e duradoura de iluminar o interior do aparelho.

Benefit (TT)

Fan

The fan contributes to an even distribution of air inside the refrigerator

Refrigerant gas R600a

Environmentally friendly R600a refrigerant gas contributes to rapid cooling with lower energy consumption

Refrigerator Internal lighting

Interior lighting for perfect visibility of shelves in the refrigerator compartment

Fruit and vegetable drawer

The fruit and vegetable drawer ensures the best storage conditions for fresh food, avoiding any contamination

Internal display

Internal display for targeted temperature control and a clean, minimalist design