

# C81721F



<b>Product Family</b>	Refrigerator
<b>Installation</b>	Built-in
<b>Category</b>	Bottom Mount
<b>Built-in niche</b>	178
<b>Reference width</b>	Until 60
<b>Reference height</b>	160 - 200
<b>Cooling type</b>	Fan assisted
<b>Defrost</b>	Automatic for refrigerator, manual for freezer
<b>Hinge type</b>	Sliding
<b>Hinge position</b>	Right
<b>Reversible door</b>	Yes
<b>EAN code</b>	8017709295356



## Aesthetics



<b>Aesthetic</b>	Universale	<b>Logo</b>	Silk screen
<b>Colour</b>	White	<b>Door shelves profile color</b>	Silver
<b>Material</b>	Metal sheet	<b>Drawers profile color</b>	Silver
<b>Handle type</b>	Fixed	<b>Color of glass shelf profile</b>	Chrome
<b>Side material</b>	Steel	<b>Display</b>	LED
<b>Side colour</b>	White	<b>Display position</b>	Interno (cella frigo)

## Refrigerator compartment features



<b>No. of adjustable shelves</b>	4	<b>Crisper Cover</b>	Yes
<b>Number of fruit and vegetables drawers</b>	2	<b>Type of crisper/vegetable drawers cover</b>	Glass
<b>Type of adjustable shelves</b>	Glass	<b>Internal light in fridge</b>	Yes
<b>Type of crisper/vegetable drawers cover</b>	Standard	<b>Type of internal light (fridge)</b>	LED

## Refrigerator Inner Door

<b>No. of door shelves with transparent cover</b>	1	<b>No. of bottle shelves</b>	1
---	---	------------------------------	---

Number of adjustable door shelves 2

## Other Refrigerator features



Accessories	Egg tray	Fan	Yes
-------------	----------	-----	-----

## Freezer compartment features

Number of drawers 3

## Other Freezer features

Accessories	1 ice box
-------------	-----------

## Other technical features

Type of temperature control	Electro-mechanical
No. of compressors	1
Refrigerant gas type	R600a
Type of compressor	Standard
Foam agent	Cyclopentane

## Performance / Energy Label - Reg. 2019









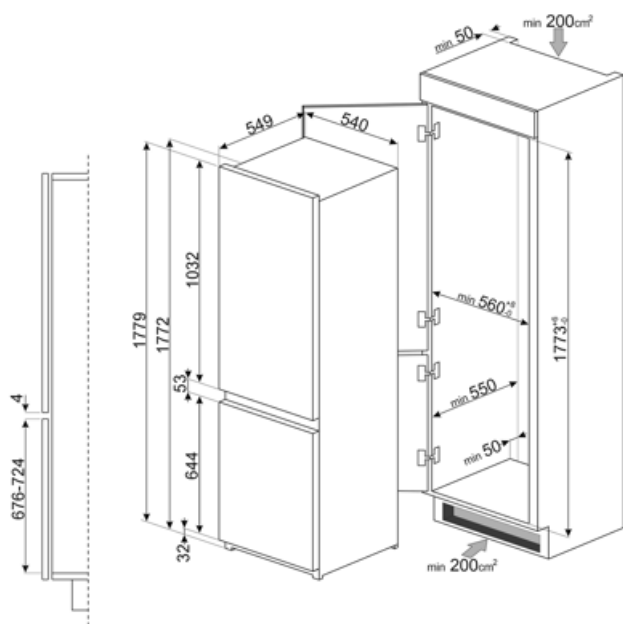

Annual energy consumption	272 kWh/a	Airborne acoustical noise emissions	35 dB(A) re 1 pW
Energy efficiency class	F	Temperature Rise Time	11.50 h
Airborne acoustical noise emission class	B	4 star - Freezing capacity	3.9 Kg/24h
Total net volume	268 l	Climate class	SN, N, ST, T
Sum of the volumes of the frozen compartment(s)	72 l	EEl	125 %
Sum of the volumes of the chill compartment(s) and the unfrozen compartment(s)	196 l		

## Electrical Connection

Plug	(F;E) Schuko	Voltage (V)	230-240 V
Electrical connection rating	140 W	Frequency (Hz)	50 Hz
Current	1,1 A	Power supply cable length	240 cm



## Symbols glossary

	4 stars freezing compartment for better food preservation.		The automatic defrost system works by automatically defrosting at regular intervals eliminating the need to defrost altogether.
	A+: Energy efficiency class A+ helps to save up to 10% energy compared to class A. Maximum performance with minimum consumption is guaranteed.		Energy efficiency class F
	LED display: to show programmes, functions and options selected and the time to the end of the cycle.		Ventilated: Forced distribution of cold air in the refrigerator compartment, which allows even temperature distribution within the fridge.
	LED interior lighting: is a more energy efficient and long lasting way of illuminating the interior of the appliance.		Built-in niche

## Benefit (TT)

---

### **Fan**

The fan contributes to an even distribution of air inside the refrigerator

### **Refrigerant gas R600a**

Environmentally friendly R600a refrigerant gas contributes to rapid cooling with lower energy consumption

### **Climate class**

Climatic class SN-T makes the appliance suitable for working at room temperature between 10 °C and 43 °C (50 °F ~ 109 °F)

### **Refrigerator Internal lighting**

Interior lighting for perfect visibility of shelves in the refrigerator compartment

### **Fruit and vegetable drawer**

The fruit and vegetable drawer ensures the best storage conditions for fresh food, avoiding any contamination

### **Internal display**

Internal display for targeted temperature control and a clean, minimalist design