

C8173N1F



Product Family	Refrigerator
Installation	Built-in
Category	Bottom Mount
Built-in niche	178
Reference width	Until 60
Reference height	160 - 200
Cooling type	Fan assisted refrigerator, no-frost freezer
Defrost	Automatic
Hinge type	Sliding
Hinge position	Right
Reversible door	Yes
EAN code	8017709295295



Aesthetics

			
Aesthetic	Universale	Logo	Silk screen
Colour	White	Door shelves profile color	Silver
Material	Metal sheet	Drawers profile color	Silver
Handle type	Fixed	Color of glass shelf profile	Chrome
Side material	Steel	Display	LED
Side colour	White	Display position	Interno (cella frigo)

Refrigerator compartment features

			
No. of adjustable shelves	4	Crisper Cover	Yes
Number of fruit and vegetables drawers	2	Type of crisper/vegetable drawers cover	Glass
Type of adjustable shelves	Glass	Internal light in fridge	Yes
Type of crisper/vegetable drawers cover	Standard	Type of internal light (fridge)	LED

Refrigerator Inner Door

No. of door shelves with transparent cover	1	No. of bottle shelves	1
--	---	-----------------------	---

Number of adjustable door shelves 2

Other Refrigerator features



Accessories Egg tray Fan Yes

Freezer compartment features

Number of drawers 3

Other Freezer features

Accessories 1 ice box, 1 eutectic

Other technical features



Functions display	Fast freezing
Type of temperature control	Electronic
No. of compressors	1
Refrigerant gas type	R600a
Type of compressor	Standard
Refrigerant Quantity (gr)	50 g
Foam agent	Cyclopentane

Performance / Energy Label NEW 2019









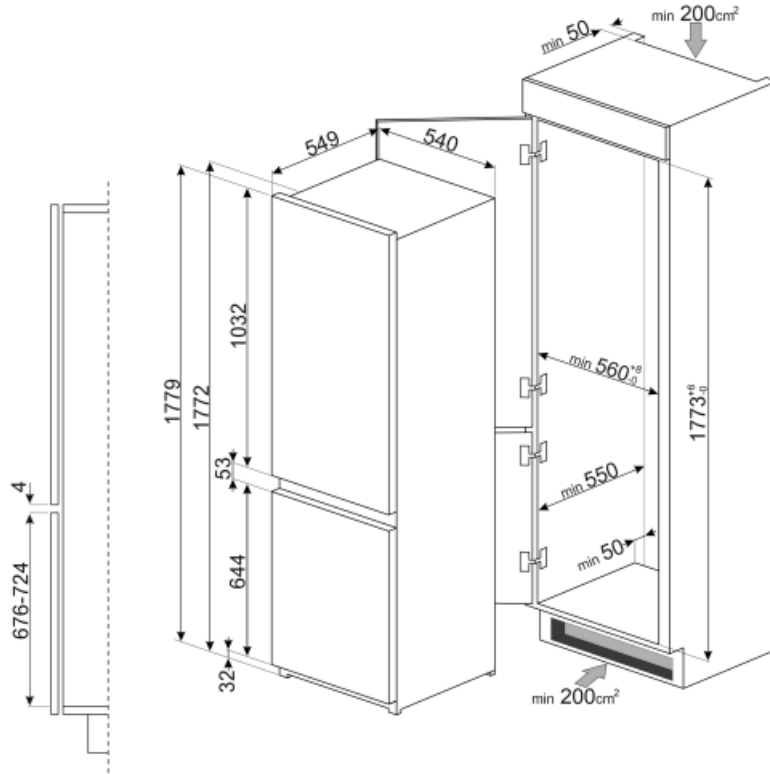



Annual energy consumption	268 kWh/a	Airborne acoustical noise emissions	36 dB(A) re 1pW
Energy efficiency class	F	Temperature Rise Time	9.00 h
Airborne acoustical noise emission class	C	4 star - Freezing capacity	5.0 Kg/24h
Total net volume	254 l	Climate class	SN, N, ST, T
Sum of the volumes of the frozen compartment(s)	61 l	EEl	125 %
Sum of the volumes of the chill compartment(s) and the unfrozen compartment(s)	193 l		

Electrical Connection

Plug	(F;E) Schuko	Voltage (V)	230-240 V
Electrical connection rating	100 W	Frequency (Hz)	50 Hz
Current	1.1 A	Power supply cable length	240 cm



Symbols glossary (TT)

	4 stars freezing compartment for better food preservation.		The automatic defrost system works by automatically defrosting at regular intervals eliminating the need to defrost altogether.
	LED display: to show programmes, functions and options selected and the time to the end of the cycle.		Energy efficiency class F
	A+: Energy efficiency class A+ helps to save up to 10% energy compared to class A. Maximum performance with minimum consumption is guaranteed.		Ventilated: Forced distribution of cold air in the refrigerator compartment, which allows even temperature distribution within the fridge.
	Fast freezing: The fast freezing function brings the temperature of the compartment down when activated a few hours prior to usage.		LED interior lighting: is a more energy efficient and long lasting way of illuminating the interior of the appliance.
	Built-in niche		No Frost: The No Frost and Frost free systems prevent ice from forming so that no defrosting is required.