

C8173N1F



Product Family	Refrigerator
Installation	Built-in
Category	Bottom Mount
Built-in niche	178
Reference width	Until 60
Reference height	160 - 200
Cooling type	Fan assisted refrigerator, no-frost freezer
Defrost	Automatic
Hinge type	Sliding
Hinge position	Right
Reversible door	Yes
EAN code	8017709295295



Aesthetics



Aesthetic	Universal	Cor do perfil das prateleiras da porta	Silver
Colour	White	Cor do perfil das gavetas	Silver
Material	Metal sheet	Cor do perfil da prateleira de vidro	Chrome
Handle type	Fixed	Display	LED
Side material	Steel	Mostrar porções	Interno (cela frigo)
Side colour	White	Dispenser	No
Logotipo	Logotipo serigrafado	Water Filter	No

Refrigerator compartment features



No. of adjustable shelves	4	Type of crisper/vegetable drawers cover	Glass
Number of fruit and vegetables drawers	2	Life Plus zone-0°C	No
Type of adjustable shelves	Glass	Compartimento baixa temperatura	No
Type of crisper/vegetable drawers cover	Standard	Internal light in fridge	Yes
Crisper Cover	Yes	Type of internal light (fridge)	LED
Bottle shelf	No		

Refrigerator Inner Door

No. of door shelves with transparent cover	1	No. of bottle shelves	1
Number of adjustable door shelves	2	Bottle shelves with wire support	No
Adjustable door shelves with wire support	No		

Other Refrigerator features



Accessories	Egg tray	Ionizer	No
Natural Plus Blu Light	No	Tecnologia de titânio	No
MultiFlow	No	Filtro de odor antibacteriano	No
Fan	Yes	Zona de cuidados biológicos	No

Freezer compartment features

Number of drawers	3	Type of internal light (freezer)	No
Internal light in freezer	No		

Freezer Inner Door

Pizza box	No
-----------	----

Other Freezer features

Accessories	1 ice box, 1 eutectic	Fast freezing compartment	No
Manual ice maker	No	Ice tray shelf	No
Ice maker	No		

Other technical features



Functions display	MultiZone	Fast freezing	No
Fast freezing button	Ligação à rede de água		No
Power on lamp	Temperature alarm lamp		No
Type of temperature control	No. of compressors		Electronic
			1

Refrigerant gas type	R600a
Type of compressor	Standard
Refrigerant Quantity (gr)	50 g
Espuma expansiva de isolamento	Ciclopentano

Etiqueta de Desempenho / Energia - Reg. 2019







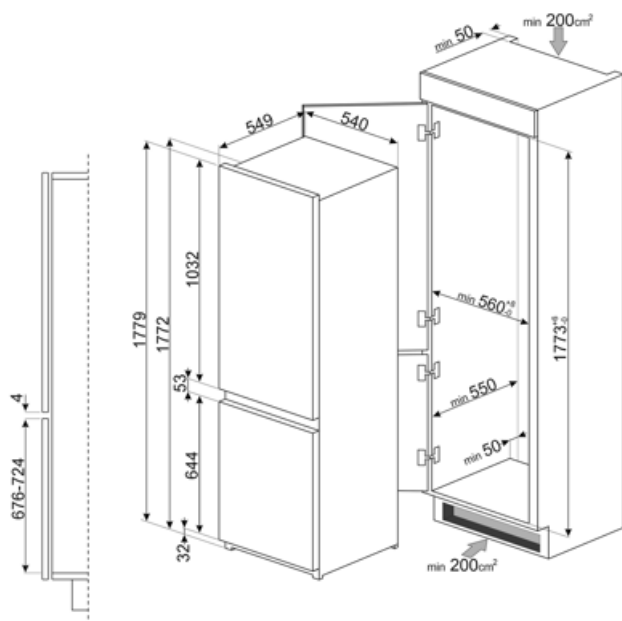



			
Consumo de energia anual	268 kWh/a	Airborne acoustical noise emissions	36 dB(A) re 1 pW
Classe de eficiência energética	F	Autonomia de conservação sem energia elétrica	9.00 h
Classe de emissão de ruído acústico aerotransportado	C	4 estrelas - Capacidade de congelamento	5.0 Kg/24h
Volume líquido total	254 l	Classe climática	SN, N, ST, T
Soma dos volumes do(s) compartimento(s) congelado(s)	61 l	EI	125 %
Soma dos volumes do(s) compartimento(s) refrigerado(s) e do(s) compartimento(s) não congelado(s)	193 l		

Electrical Connection

Plug	(F;E) Schuko	Voltage (V)	230-240 V
Electrical connection rating	100 W	Frequency (Hz)	50 Hz
Current	1.1 A	Power supply cable length	240 cm



Symbols glossary

- | | | | |
|--|--|---|--|
|  | Compartimento de congelamento de 4 estrelas para uma melhor preservação dos alimentos. |  | A+: A classe de eficiência energética A+ ajuda a economizar até 10% de energia em comparação com a classe A. O desempenho máximo com consumo mínimo é garantido. |
|  | O sistema de descongelamento automático funciona descongelando automaticamente em intervalos regulares, eliminando a necessidade de descongelar completamente. |  | Display LED: para mostrar os programas, funções e opções selecionadas e o tempo até ao final do ciclo. |
|  | Ventilado: Distribuição forçada de ar frio no compartimento da geladeira, o que permite uma distribuição uniforme da temperatura dentro da geladeira. |  | CONGELAMENTO RÁPIDO: A função de congelamento rápido reduz a temperatura do compartimento quando ativado algumas horas antes do uso. |
|  | Iluminação interior LED: é uma forma mais eficiente em termos energéticos e duradoura de iluminar o interior do aparelho. |  | Nicho incorporado |
|  | No Frost: Os sistemas sem geada e livre de geada impedem a formação de gelo, de modo que não é necessário descongelar. |  | Classe de eficiência energética F |

Benefit (TT)

Fan

The fan contributes to an even distribution of air inside the refrigerator

Refrigerant gas R600a

Environmentally friendly R600a refrigerant gas contributes to rapid cooling with lower energy consumption

Climate class

Climatic class SN-T makes the appliance suitable for working at room temperature between 10 °C and 43 °C (50 °F ~ 109 °F)

Refrigerator Internal lighting

Interior lighting for perfect visibility of shelves in the refrigerator compartment

Fruit and vegetable drawer

The fruit and vegetable drawer ensures the best storage conditions for fresh food, avoiding any contamination

Internal display

Internal display for targeted temperature control and a clean, minimalist design