

# C8174DN2E



<b>Product Family</b>	Refrigerator
<b>Installation</b>	Built-in
<b>Category</b>	Bottom Mount
<b>Built-in niche</b>	178
<b>Reference width</b>	Until 60
<b>Reference height</b>	160 - 200
<b>Sistema Total No - Frost</b>	Only freezer
<b>Cooling type</b>	Fan assisted refrigerator, no-frost freezer
<b>Defrost</b>	Automatic
<b>Hinge type</b>	Door on door
<b>Hinge position</b>	Right
<b>Reversible door</b>	Yes
<b>EAN code</b>	8017709292355



## Aesthetics



<b>Aesthetic</b>	Universal	<b>Cor do perfil da prateleira de vidro</b>	Chrome
<b>Colour</b>	White	<b>Display</b>	LCD Touch
<b>Side material</b>	Steel	<b>Mostrar porções</b>	Interno (no Topo)
<b>Side colour</b>	White	<b>Dispenser</b>	No
<b>Logotipo</b>	Logotipo serigrafado	<b>Water Filter</b>	No
<b>Cor do perfil das prateleiras da porta</b>	Silver	<b>HomeBar</b>	No
<b>Cor do perfil das gavetas</b>	Silver		

## Refrigerator compartment features



<b>No. of adjustable shelves</b>	3	<b>Type of crisper/vegetable drawers cover</b>	Glass
<b>Number of fruit and vegetables drawers</b>	2	<b>Life Plus zone-0°C</b>	No
<b>Type of adjustable shelves</b>	Glass	<b>Compartimento baixa temperatura</b>	No
<b>Type of crisper/vegetable drawers cover</b>	Standard	<b>Internal light in fridge</b>	Yes
<b>Crisper Cover</b>	Yes	<b>Type of internal light (fridge)</b>	LED
<b>Bottle shelf</b>	No		

## Refrigerator Inner Door

<b>No. of door shelves with transparent cover</b>	1	<b>No. of bottle shelves</b>	1
<b>Number of adjustable door shelves</b>	2	<b>Bottle shelves with wire support</b>	No
<b>Adjustable door shelves with wire support</b>	No		

## Other Refrigerator features



<b>Accessories</b>	Egg tray	<b>Fan</b>	Yes
<b>Natural Plus Blu Light</b>	No	<b>Ionizer</b>	No
<b>MultiFlow</b>	No		

## Freezer compartment features

<b>Number of drawers</b>	3	<b>Type of internal light (freezer)</b>	No
<b>Internal light in freezer</b>	No		

## Freezer Inner Door

<b>Pizza box</b>	No
------------------	----

## Other Freezer features

<b>Accessories</b>	1 ice box, 2 eutectics	<b>Fast freezing compartment</b>	No
<b>Manual ice maker</b>	No	<b>Ice tray shelf</b>	No

## Other technical features



<b>Functions display</b>	Holiday, Fast freezing, Fast cooling, Control lock, Temperature alarm, Cooling timer
<b>MultiZone</b>	No
<b>Ligação à rede de água</b>	No
<b>Temperature alarm lamp</b>	Yes
<b>Door open alarm</b>	Yes
<b>Temperature Alarm</b>	Yes
<b>Antibacterial Gasket</b>	No
<b>Type of temperature control</b>	Electronic
<b>No. of compressors</b>	1
<b>Refrigerant gas type</b>	R600a
<b>Type of compressor</b>	Standard
<b>Refrigerant Quantity (gr)</b>	48 g
<b>Max weight door panel (fridge)</b>	20 kg
<b>Espuma expansiva de isolamento</b>	Ciclopentano

## Etiqueta de Desempenho / Energia - Reg. 2019









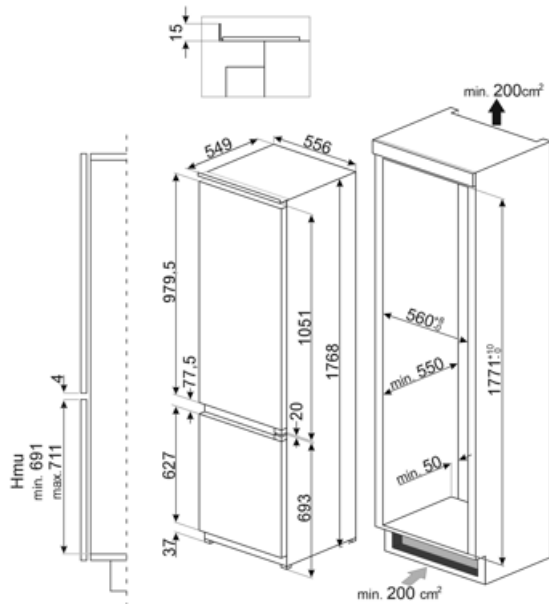





<b>Consumo de energia anual</b>	214 kWh/a	<b>Airborne acoustical noise emissions</b>	37 dB(A) re 1 pW
<b>Classe de eficiência energética</b>	E	<b>Autonomia de conservação sem energia elétrica</b>	11.00 h
<b>Classe de emissão de ruído acústico aerotransportado</b>	C	<b>4 estrelas - Capacidade de congelamento</b>	4.5 Kg/24h
<b>Volume líquido total</b>	248 l	<b>Classe climática</b>	SN, N, ST, T
<b>Soma dos volumes do(s) compartimento(s) congelado(s)</b>	61 l	<b>EEl</b>	100 %
<b>Soma dos volumes do(s) compartimento(s) refrigerado(s) e do(s) compartimento(s) não congelado(s)</b>	187 l		

## Electrical Connection

<b>Plug</b>	(F;E) Schuko	<b>Voltage (V)</b>	230-240 V
<b>Electrical connection rating</b>	140 W	<b>Frequency (Hz)</b>	50 Hz
<b>Current</b>	1,1 A	<b>Power supply cable length</b>	240 cm



## Symbols glossary

-  Compartimento de congelamento de 4 estrelas para uma melhor preservação dos alimentos.
-  Bloqueio para crianças: alguns modelos estão equipados com um dispositivo para bloquear o programa/ciclo para que não possa ser acidentalmente alterado.
-  Classe de eficiência energética E.
-  Ventilado: Distribuição forçada de ar frio no compartimento da geladeira, o que permite uma distribuição uniforme da temperatura dentro da geladeira.
-  Modo de economia de energia: O modo de economia de energia permite-lhe desativar a geladeira e manter o congelador a funcionar.
-  Nicho incorporado
-  O sistema de descongelamento automático funciona descongelando automaticamente em intervalos regulares, eliminando a necessidade de descongelar completamente.
-  A++: A classe de eficiência energética A++ ajuda a economizar até 20% de energia em comparação com a classe A. O desempenho máximo com consumo mínimo é garantido.
-  Display LCD: para otimizar o desempenho e simplificar o uso do aparelho.
-  CONGELAMENTO RÁPIDO: A função de congelamento rápido reduz a temperatura do compartimento quando ativado algumas horas antes do uso.
-  Iluminação interior LED: é uma forma mais eficiente em termos energéticos e duradoura de iluminar o interior do aparelho.
-  No Frost: Os sistemas sem geada e livre de geada impedem a formação de gelo, de modo que não é necessário descongelar.

---

## Benefit (TT)

---

### **Fan**

The fan contributes to an even distribution of air inside the refrigerator

### **Refrigerant gas R600a**

Environmentally friendly R600a refrigerant gas contributes to rapid cooling with lower energy consumption

### **Climate class**

Climatic class SN-T makes the appliance suitable for working at room temperature between 10 °C and 43 °C (50 °F ~ 109 °F)

### **Self-supporting hinges**

Self-supporting hinges ensure a perfect fit between the equipment door and the cabinet door, giving the product a minimalist and elegant appearance

### **Refrigerator Internal lighting**

Interior lighting for perfect visibility of shelves in the refrigerator compartment

### **Fruit and vegetable drawer**

The fruit and vegetable drawer ensures the best storage conditions for fresh food, avoiding any contamination

### **Internal display**

Internal display for targeted temperature control and a clean, minimalist design