

## C8174TNE



Product familie	Koelkast
Installatie	Inbouw
Categorie	Koel-vriescombinatie
Inbouwnis	178
Referentie breedte	Tot 60 cm cm
Referentie hoogte	160 - 200 cm cm
No Frost systeem	Totaal No-Frost
Type koelen	Dubbel koelsysteem
Ontdooien	Automatisch ontdooien
Type scharnier	Bevestiging met geleiders
Positie scharnier	Rechts
Deur omkeerbaar	Ja
EAN-code	8017709293406



## Design



Design	Universeel	Kleur profielen binnenzijde	Zilver
Kleur	Wit	Kleur profielen laden	Zilver
Materiaal deur	Plaatstaal	Kleur profiel glazen leggers	Chroom
Materiaal zijwanden	Staal	Display	Touch LCD
Kleur zijkanten	Wit	Positie display	Binnen (bovenzijde)

## Uitrusting koelkast



Number of compartments	2	Flessenhouder	Ja
Compartment types	Fruit and vegetable compartment, Life Plus Compartment	Type afdekplaat groente-/fruitlade	Glas
Aantal verstelbare leggers	2	Life Plus zone 0°C	Ja
Aantal groente-/fruitlades	1	Convertible temperature drawer	No
Shelves material	Glas	Binnenverlichting koelkast	Ja
Type afdekplaat groente-/fruitlade	Standaard	Type binnenverlichting koelkast	LED
Afdekplaat groentenlade	Ja		

## Binnendeur koelkast

Aantal verstelbare binnendeurcompartimenten	2	Aantal flessenhouders	1
---	---	-----------------------	---

## Overige features koelkast



Humidity Control	No	MultiFlow	Ja
Accessoires	Eierhouder	Ventilator	Ja

## Uitrusting vriezer

Aantal lades	3	Aantal legplanken	2
--------------	---	-------------------	---

## Overige features vriezer



Accessoires	1 ijsblokjeshouder	Snel-vriescompartiment	Ja
-------------	--------------------	------------------------	----

## Overige technische eigenschappen



Display functies	Vakantiefunctie, Snel-vriesfunctie, Snel-koelfunctie, Temperatuuralarm
Alarm open deur	Ja
Temperature Alarm	Ja
Type temperatuurcontrole	Elektronisch
Aantal compressoren	1
Type koelgas	R600a
Type compressor	Variabele toeren
Schuimmiddel	Cyclopentaan

## Prestaties/Energie label - Reg. 2019



Annual energy consumption	224 kWh/jaar	Geluidsniveau	38 dB(A) re 1 pW
Energie-efficiëntieklasse	E	Conserveringsduur zonder stroom	13 h
Emissieklasse voor akoestisch luchtgeluid	C	4 star - Freezing capacity	3,2 kg/24h
Totaal netto volume	254 l	Klimaatklasse	SN, T
Netto inhoud vriesgedeelte	69 l	EEL	99 %

Netto inhoud 185 l  
koelgedeeltes

## Elektrische aansluiting

Nominale aansluitwaarde 125 W  
Stroom (A) 0,8 A  
Spanning (V) 220-240 V

Frequentie (Hz) 50 Hz  
Lengte stroomkabel 150 cm  
Stekker (F;E) Schuko







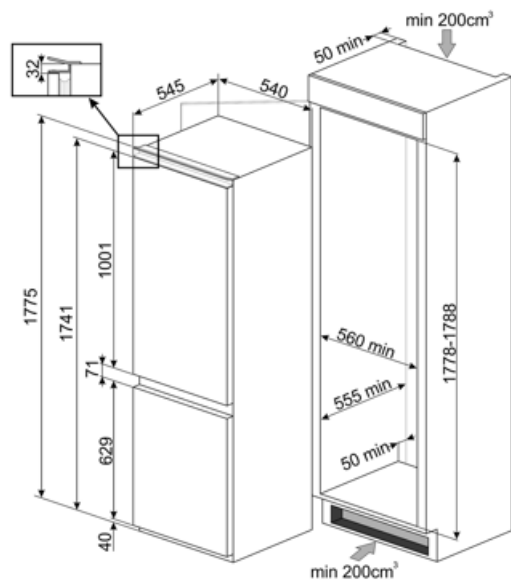





## Logistieke informatie

Breedte product (mm) 540 mm  
Diepte zonder handvat en spacer 545 mm

Maximum hoogte 1775 mm  
Product breedte met maximale deuropening 540 mm



## Symbols glossary

 <p>4 stars freezing compartment for better food preservation.</p>	 <p>A++: Energy efficiency class A++ helps to save up to 20% energy compared to class A. Maximum performance with minimum consumption is guaranteed.</p>
 <p>The automatic defrost system works by automatically defrosting at regular intervals eliminating the need to defrost altogether.</p>	 <p>LCD display: to optimize performance and simplify the use of the appliance.</p>
 <p>Geventileerd: een geforceerde verdeling van koude lucht in het koelkast compartiment, die een gelijke temperatuurverdeling verzekert in de koelkast.</p>	 <p>Fast freezing: The fast freezing function brings the temperature of the compartment down when activated a few hours prior to usage.</p>
 <p>Power saving mode: The power saving mode allows you to disable the refrigerator and keep the freezer working.</p>	 <p>LED interior lighting: is a more energy efficient and long lasting way of illuminating the interior of the appliance.</p>
 <p>Life Plus 0°C: The temperature in the Lifeplus compartments is kept at 0°C, which preserves fresh meat and fish longer.</p>	 <p>De evolutie van Smeg vaatwassers naar meer intelligente en milieuvriendelijke modellen heeft ertoe geleid om de inverter technologie te gebruiken, die een significante energie- en geluidsbesparing met zich meebrengt.</p>
 <p>Multiflow Cooling System: the Multiflow ventilation system allows an even distribution of cool air around the fridge cabinet.</p>	 <p>Built-in niche</p>
 <p>Energie-efficiëntieklasse</p>	