

# C8175TNE



Product Family	Refrigerator
Installation	Built-in
Category	Bottom Mount
Built-in niche	178
Reference width	Until 60
Reference height	160 - 200
Sistema Total No - Frost	Total
Cooling type	Total sem geada - Sistema de arrefecimento duplo
Defrost	Automatic
Hinge type	Sliding
Hinge position	Right
Reversible door	Yes
EAN code	8017709293420



## Aesthetics



Aesthetic	Universal	Cor do perfil das prateleiras da porta	Silver
Colour	White	Cor do perfil das gavetas	Silver
Material	Metal sheet	Cor do perfil da prateleira de vidro	Chrome
Logo colour	Silver	Display	LCD Touch
Side material	Steel	Mostrar porções	Interno (no Topo)
Side colour	White	Dispenser	No
Logotipo	Logotipo serigrafado	Water Filter	No

## Refrigerator compartment features



No. of adjustable shelves	2	Type of crisper/vegetable drawers cover	Glass
Number of fruit and vegetables drawers	1	Life Plus zone-0°C	Yes
Type of adjustable shelves	Glass	Compartimento baixa temperatura	No
Type of crisper/vegetable drawers cover	Standard	Internal light in fridge	Yes
Crisper Cover	Yes	Type of internal light (fridge)	LED
Bottle shelf	Yes		

## Refrigerator Inner Door

Number of adjustable door shelves	2	No. of bottle shelves	1
Adjustable door shelves with wire support	No	Bottle shelves with wire support	No

## Other Refrigerator features



Accessories	Egg tray	Ionizer	No
Natural Plus Blu Light	No	Tecnologia de titânio	No
MultiFlow	Yes	Filtro de odor antibacteriano	No
Fan	Yes	Zona de cuidados biológicos	No

## Freezer compartment features

Number of drawers	3	Internal light in freezer	No
No. of shelves	2	Type of internal light (freezer)	No

## Freezer Inner Door

Pizza box	No
-----------	----

## Other Freezer features



Accessories	1 ice box	Fast freezing compartment	Yes
Manual ice maker	No	Ice tray shelf	No
Ice maker	No		

## Other technical features



Functions display	Holiday, Fast freezing, Fast cooling, Temperature alarm
MultiZone	No
Temperature alarm lamp	No
Door open alarm	Yes
Temperature Alarm	Yes
Type of temperature control	Electronic
No. of compressors	1

Refrigerant gas type	R600a
Type of compressor	Inverter
Refrigerant Quantity (gr)	44 g
Espuma expansiva de isolamento	Ciclopentano

## Etiqueta de Desempenho / Energia - Reg. 2019







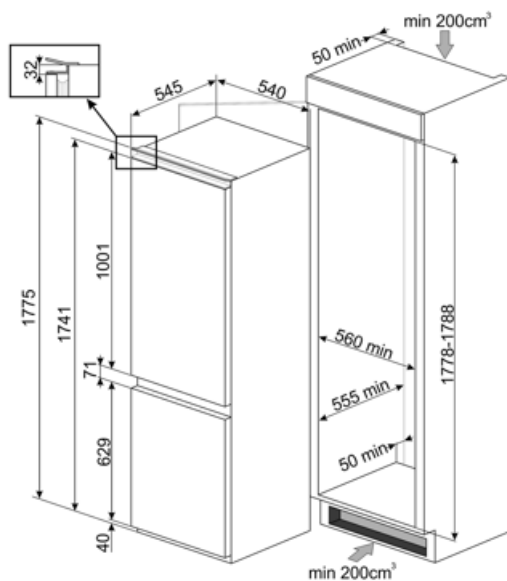





			
Consumo de energia anual	224 kWh/a	Airborne acoustical noise emissions	38 dB(A) re 1 pW
Classe de eficiência energética	E	Autonomia de conservação sem energia elétrica	13 h
Classe de emissão de ruído acústico aerotransportado	C	4 estrelas - Capacidade de congelamento	3.2 Kg/24h
Volume líquido total	254 l	Classe climática	SN, T
Soma dos volumes do(s) compartimento(s) congelado(s)	69 l	EEl	99 %
Soma dos volumes do(s) compartimento(s) refrigerado(s) e do(s) compartimento(s) não congelado(s)	185 l		

## Electrical Connection

Plug	(F;E) Schuko	Voltage (V)	220-240 V
Electrical connection rating	125 W	Frequency (Hz)	50 Hz
Current	0,8 A	Power supply cable length	150 cm



## Symbols glossary

	Compartimento de congelamento de 4 estrelas para uma melhor preservação dos alimentos.		O sistema de descongelamento automático funciona descongelando automaticamente em intervalos regulares, eliminando a necessidade de descongelar completamente.
	A++: A classe de eficiência energética A++ ajuda a economizar até 20% de energia em comparação com a classe A. O desempenho máximo com consumo mínimo é garantido.		Classe de eficiência energética E.
	Display LCD: para otimizar o desempenho e simplificar o uso do aparelho.		Ventilado: Distribuição forçada de ar frio no compartimento da geladeira, o que permite uma distribuição uniforme da temperatura dentro da geladeira.
	CONGELAMENTO RÁPIDO: A função de congelamento rápido reduz a temperatura do compartimento quando ativado algumas horas antes do uso.		Modo de economia de energia: O modo de economia de energia permite-lhe desativar a geladeira e manter o congelador a funcionar.
	Iluminação interior LED: é uma forma mais eficiente em termos energéticos e duradoura de iluminar o interior do aparelho.		Life Plus 0°C: A temperatura nos compartimentos Lifeplus é mantida a 0°C, o que preserva a carne fresca e o peixe por mais tempo.
	Tecnologia do inversor: A evolução dos secadores Smeg para modelos mais inteligentes e ambientalmente sustentáveis levou à escolha do uso da tecnologia do inversor com bombas de calor, o que reduz significativamente o consumo de energia.		Ar mais: mantém a comida mais fresca por mais tempo.
	Nicho incorporado		

## Benefit (TT)

---

### **No-Frost system**

The No Frost system prevents the formation of ice and contributes to better preservation of food in the refrigerator

### **Plastic multiflow system**

The Multiflow system ensures even distribution of cold air inside the refrigerator

### **Fan**

The fan contributes to an even distribution of air inside the refrigerator

### **Refrigerant gas R600a**

Environmentally friendly R600a refrigerant gas contributes to rapid cooling with lower energy consumption

### **Climate class**

Climatic class SN-T makes the appliance suitable for working at room temperature between 10 °C and 43 °C (50 °F ~ 109 °F)

### **Life Plus 0°**

Temperature-controlled Life Plus compartment for optimal storage of specific food categories

### **Refrigerator Internal lighting**

Interior lighting for perfect visibility of shelves in the refrigerator compartment

### **Fruit and vegetable drawer**

The fruit and vegetable drawer ensures the best storage conditions for fresh food, avoiding any contamination

### **Inverter compressor**

Inverter compressor reduces noise and vibration levels for a quiet and comfortable kitchen environment

Inverter compressor technology offers significant advantages for refrigeration systems, improving both performance and efficiency. Better temperature control ensures a more stable and constant indoor environment, preserving the freshness of food. This technology also results in reduced energy consumption, as the compressor adjusts its speed according to cooling needs.

### **Internal display**

Internal display for targeted temperature control and a clean, minimalist design