

C8194TNE



Product familie	Koelkast
Installatie	Inbouw
Categorie	Koel-vriescombinatie
Inbouwnis	190-195
Referentie breedte	Tot 60 cm cm
Referentie hoogte	160 - 200 cm cm
No Frost systeem	Totaal No-Frost
Type koelen	Dubbel koelsysteem
Ontdooien	Automatisch ontdooien
Type scharnier	Bevestiging met geleiders
Positie scharnier	Rechts
Deur omkeerbaar	Ja
EAN-code	8017709293444



Design



Design	Universeel	Logo	Geëtst
Kleur	Wit	Kleur profielen binnenzijde	Zilver
Materiaal deur	Plaatstaal	Kleur profielen laden	Zilver
Kleur logo	Zilver	Kleur profiel glazen leggers	Chroom
Materiaal zijwanden	Staal	Display	LED
Kleur zijkanten	Wit	Positie display	Binnen (bovenzijde)

Uitrusting koelkast



Number of compartments	2	Flessenhouder	Ja
Compartment types	Fruit and vegetable compartment, Life Plus Compartment	Type afdekplaat groente-/fruitlade	Glas
Aantal verstelbare leggers	4	Life Plus zone 0°C	Ja
Aantal groente-/fruitlades	1	Convertible temperature drawer	No
Shelves material	Glas	Binnenverlichting koelkast	Ja
Type afdekplaat groente-/fruitlade	Standaard	Type binnenverlichting koelkast	LED
Afdekplaat groentenlade	Ja		

Binnendeur koelkast

Aantal verstelbare binnendeurcompartimenten	3	Aantal flessenhouders	1
---	---	-----------------------	---

Overige features koelkast



Humidity Control	No	MultiFlow	Ja
Accessoires	Eierhouder	Ventilator	Ja

Uitrusting vriezer

Aantal lades	3
--------------	---

Overige features vriezer



Accessoires	1 ijsblokjeshouder	Snel-vriescompartment	Ja
-------------	--------------------	-----------------------	----

Overige technische eigenschappen



Display functies	Vakantiefunctie, Snel-vriesfunctie, Snel-koelfunctie, ECO, Temperatuuralarm
Snel-vriestoets	Ja
Alarm open deur	Ja
Type temperatuurcontrole	Elektronisch
Aantal compressoren	1
Type koelgas	R600a
Type compressor	Variabele toeren
Hoeveelheid koelmiddel	46 g
Schuimmiddel	Cyclopentaan

Prestaties/Energie label - Reg. 2019

			
Annual energy consumption	223 kWh/jaar	Geluidsniveau	37 dB(A) re 1 pW
Energie-efficiëntieklasse	E	Conserveringsduur zonder stroom	13 h
Emissieklasse voor akoestisch luchtgeluid	C	4 star - Freezing capacity	3,2 kg/24h
Totaal netto volume	284 l	Klimaatklasse	SN, T
		EI	99 %

Netto inhoud vriesgedeelte	69 l
Netto inhoud koelgedeeltes	215 l

Elektrische aansluiting







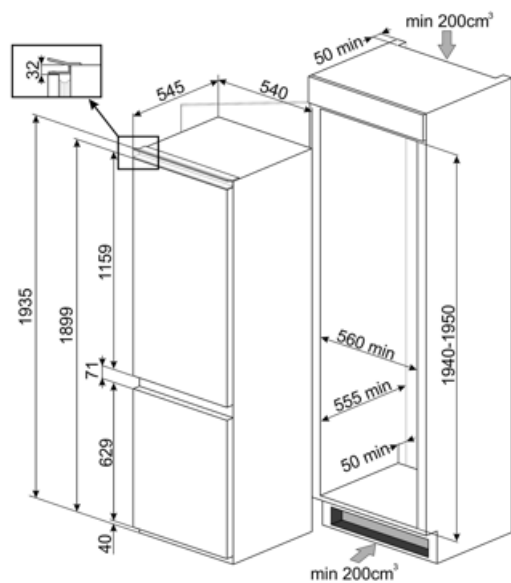







Nominale aansluitwaarde	125 W	Frequentie (Hz)	50 Hz
Stroom (A)	0,8 A	Lengte stroomkabel	190 cm
Spanning (V)	220-240 V	Stekker	(F;E) Schuko

Logistieke informatie

Breedte product (mm)	540 mm	Product breedte met maximale deuropening	540 mm
Diepte zonder handvat en spacer	545 mm	Diepte uitsparing	38 mm
Maximum hoogte	1935 mm		



Symbols glossary

	4 stars freezing compartment for better food preservation.		A++: Energy efficiency class A++ helps to save up to 20% energy compared to class A. Maximum performance with minimum consumption is guaranteed.
	The automatic defrost system works by automatically defrosting at regular intervals eliminating the need to defrost altogether.		LED display: to show programmes, functions and options selected and the time to the end of the cycle.
	Economical mode: Analyzes fridge functioning during the activation and optimizes the operating cycle in order to reduce power consumption.		Geventileerd: een geforceerde verdeling van koude lucht in het koelkast compartiment, die een gelijke temperatuurverdeling verzekert in de koelkast.
	Fast freezing: The fast freezing function brings the temperature of the compartment down when activated a few hours prior to usage.		Power saving mode: The power saving mode allows you to disable the refrigerator and keep the freezer working.
	LED interior lighting: is a more energy efficient and long lasting way of illuminating the interior of the appliance.		Life Plus 0°C: The temperature in the Lifeplus compartments is kept at 0°C, which preserves fresh meat and fish longer.
	De evolutie van Smeg vaatwassers naar meer intelligente en milieuvriendelijke modellen heeft ertoe geleid om de inverter technologie te gebruiken, die een significante energie- en geluidsbesparing met zich meebrengt.		Multiflow Cooling System: the Multiflow ventilation system allows an even distribution of cool air around the fridge cabinet.
	Built-in niche		Energie-efficiëntieklasse