

C875TNE



Product Family	Refrigerator
Installation	Built-in
Category	Bottom Mount
Built-in niche	200
Reference width	70 - 80 cm
Reference height	160 - 200 cm
Sistema Total No - Frost	Yes
Cooling type	Total No Frost
Defrost	Automatic
Hinge type	Sliding
Hinge position	Right
Reversible door	Yes
EAN code	8017709321178



Aesthetics

Aesthetic	Universale	Door shelves profile color	Chrome
Colour	White	Drawers profile color	Chrome
Material	Metal sheet	Color of glass shelf profile	Chrome
Side material	Steel	Display	7 segments
Side colour	White	Display position	Interno (sul Top)

Refrigerator compartment features



Number of compartments	2	Crisper Cover	Yes
Compartment types	Low temperature compartment, Fruit and vegetable compartment	Bottle shelf	Yes
No. of adjustable shelves	3	Type of crisper/vegetable drawers cover	Glass
Number of fruit and vegetables drawers	1	Low temperature compartment	Yes
Shelves material	Glass	Internal light in fridge	Yes
Type of crisper/vegetable drawers cover	Standard	Type of internal light (fridge)	LED

Refrigerator Inner Door

Number of adjustable door shelves	5	Bottle shelves with wire support	Yes
No. of bottle shelves	1		

Other Refrigerator features



Accessories	Egg tray	Fan	Yes
Natural Plus Blu Light	Yes	Antibacterial odour filter	Yes
MultiFlow	Yes		

Freezer compartment features

Number of drawers	3	No. of shelves	2
-------------------	---	----------------	---

Other Freezer features



Accessories	1 ice box	Ice tray shelf	Yes
Fast freezing compartment	Yes		

Other technical features



Functions display	Holiday, Fast freezing, Fast cooling, Temperature alarm
Door open alarm	Yes
Temperature Alarm	Yes
Type of temperature control	Electronic
No. of compressors	1
Refrigerant gas type	R600a
Type of compressor	Inverter
Foam agent	Cyclopentane

Performance / Energy Label - Reg. 2019



Annual energy consumption	247 kWh/a	Airborne acoustical noise emissions	35 dB(A) re 1 pW
Energy efficiency class	E	Temperature Rise Time	9 h
Airborne acoustical noise emission class	B	4 star - Freezing capacity	5,2 kg/24h
Total net volume	370 l	Climate class	SN, T
Sum of the volumes of the frozen compartment(s)	90 l	EI	100 %

Sum of the volumes of the chill compartment(s) and the unfrozen compartment(s) 280 l

Electrical Connection







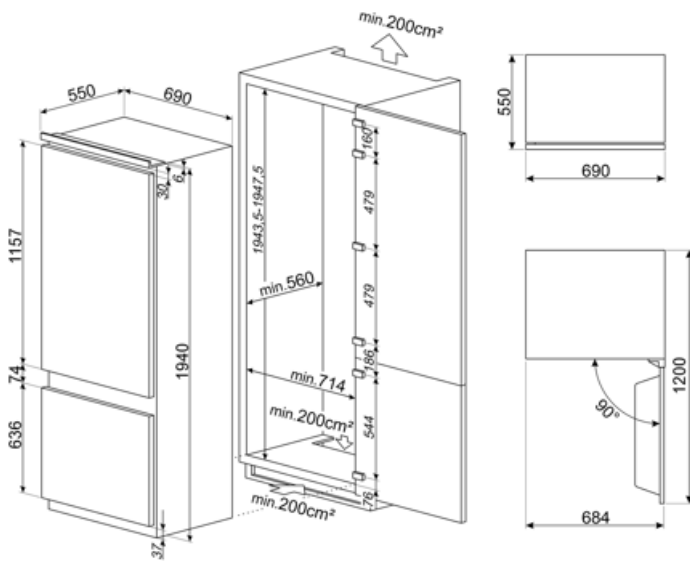



Electrical connection rating	95 W	Frequency (Hz)	50 Hz
Current	0,8 A	Power supply cable length	193 cm
Voltage (V)	220-240 V	Plug	(F;E) Schuko

Logistic Information

Width	690 mm	Height	1940 mm
Width of the built-in niche	730 mm	Height of the built-in niche	1943 mm
Depth without handle	550 mm	Product width with maximum doors opening	1069 mm
Depth of the built-in niche	560 mm	Product depth with doors open at 90°	1222 mm



Symbols glossary

- | | | | |
|--|--|---|---|
|  | The automatic defrost system works by automatically defrosting at regular intervals eliminating the need to defrost altogether. |  | Energy efficiency class E |
|  | Ventilated: Forced distribution of cold air in the refrigerator compartment, which allows even temperature distribution within the fridge. |  | Fast freezing: The fast freezing function brings the temperature of the compartment down when activated a few hours prior to usage. |
|  | Power saving mode: The power saving mode allows you to disable the refrigerator and keep the freezer working. |  | LED interior lighting: is a more energy efficient and long lasting way of illuminating the interior of the appliance. |
|  | Smeg's evolution towards more intelligent and eco-friendly models has led to the choice of Inverter technology, which significantly reduces consumption. |  | Multiflow Cooling System: the Multiflow ventilation system allows an even distribution of cool air around the fridge cabinet. |
|  | Natural Plus Blu Light: This unique Natural Plus Blu Light system works with nature to increase the storage time of fruit and vegetables. |  | Built-in niche |