

C875TNE



Product Family	Refrigerator
Installation	Built-in
Category	Bottom Mount
Built-in niche	200
Reference width	70 - 80
Reference height	160 - 200
Sistema Total No - Frost	Yes
Cooling type	Total No Frost
Defrost	Automatic
Hinge type	Sliding
Hinge position	Right
Reversible door	Yes
EAN code	8017709321178



Aesthetics

Aesthetic	Universal	Cor do perfil das gavetas	Chrome
Colour	White	Cor do perfil da prateleira de vidro	Chrome
Material	Metal sheet	Display	7 segments
Side material	Steel	Mostrar porções	Interno (no Topo)
Side colour	White	Dispenser	No
Cor do perfil das prateleiras da porta	Chrome		

Refrigerator compartment features



No. of adjustable shelves	3	Type of crisper/vegetable drawers cover	Glass
Number of fruit and vegetables drawers	1	Life Plus zone-0°C	Yes
Type of adjustable shelves	Glass	Compartimento baixa temperatura	No
Type of crisper/vegetable drawers cover	Standard	Internal light in fridge	Yes
Crisper Cover	Yes	Type of internal light (fridge)	LED
Bottle shelf	Yes		

Refrigerator Inner Door

Number of adjustable door shelves	5	No. of bottle shelves	1
-----------------------------------	---	-----------------------	---

Adjustable door shelves with wire support No

Bottle shelves with wire support Yes

Other Refrigerator features



Accessories Egg tray
 Natural Plus Blu Light Yes
 MultiFlow Yes
 Fan Yes

Ionizer No
 Tecnologia de titânio No
 Filtro de odor antibacteriano Yes
 Zona de cuidados biológicos No

Freezer compartment features

Number of drawers 3
 No. of shelves 2

Internal light in freezer No
 Type of internal light (freezer) No

Other Freezer features



Accessories 1 ice box
 Fast freezing compartment Yes

Ice tray shelf Yes

Other technical features



Functions display
 MultiZone
 Door open alarm
 Temperature Alarm
 Type of temperature control
 No. of compressors
 Refrigerant gas type
 Type of compressor
 Espuma expansiva de isolamento

Holiday, Fast freezing, Fast cooling, Temperature alarm
 No
 Yes
 Yes
 Electronic
 1
 R600a
 Inverter
 Ciclopentano

Etiqueta de Desempenho / Energia - Reg. 2019



Consumo de energia anual 247 kWh/a
 Classe de eficiência energética E

Airborne acoustical noise emissions 35 dB(A) re 1 pW







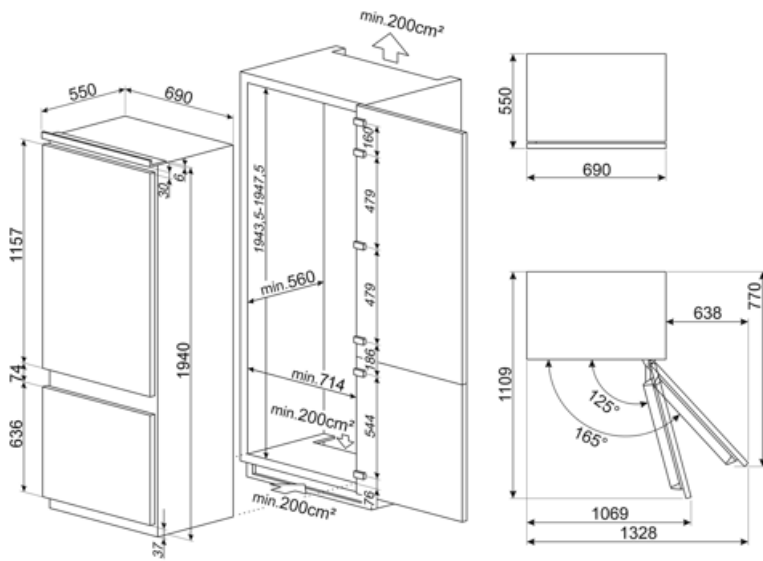



Classe de emissão de ruído acústico aerotransportado	B	Autonomia de conservação sem energia elétrica	9 h
Volume líquido total	370 l	4 estrelas - Capacidade de congelamento	5.2 Kg/24h
Soma dos volumes do(s) compartimento(s) congelado(s)	90 l	Classe climática	SN, T
Soma dos volumes do(s) compartimento(s) refrigerado(s) e do(s) compartimento(s) não congelado(s)	280 l	EI	100 %

Electrical Connection

Plug	(F;E) Schuko	Voltage (V)	220-240 V
Electrical connection rating	95 W	Frequency (Hz)	50 Hz
Current	0,8 A	Power supply cable length	193 cm



Symbols glossary

- | | | | |
|--|---|--|---|
|  | O sistema de descongelamento automático funciona descongelando automaticamente em intervalos regulares, eliminando a necessidade de descongelar completamente. |  | Ventilado: Distribuição forçada de ar frio no compartimento da geladeira, o que permite uma distribuição uniforme da temperatura dentro da geladeira. |
|  | CONGELAMENTO RÁPIDO: A função de congelamento rápido reduz a temperatura do compartimento quando ativado algumas horas antes do uso. |  | Modo de economia de energia: O modo de economia de energia permite-lhe desativar a geladeira e manter o congelador a funcionar. |
|  | Iluminação interior LED: é uma forma mais eficiente em termos energéticos e duradoura de iluminar o interior do aparelho. |  | Life Plus 0°C: A temperatura nos compartimentos Lifeplus é mantida a 0°C, o que preserva a carne fresca e o peixe por mais tempo. |
|  | Tecnologia do inversor: A evolução dos secadores Smeg para modelos mais inteligentes e ambientalmente sustentáveis levou à escolha do uso da tecnologia do inversor com bombas de calor, o que reduz significativamente o consumo de energia. |  | Ar mais: mantém a comida mais fresca por mais tempo. |
|  | Natural Plus Blu Light: Este exclusivo sistema Natural Plus Blu Light trabalha com a natureza para aumentar o tempo de armazenamento de frutas e legumes. |  | Nicho incorporado |
|  | Classe de eficiência energética E. | | |

Benefit (TT)

No-Frost system

The No Frost system prevents the formation of ice and contributes to better preservation of food in the refrigerator

Natural Plus Blue Light

The Natural plus Blue light system extends the shelf life of fruit and vegetables while preserving their organoleptic properties

Plastic multiflow system

The Multiflow system ensures even distribution of cold air inside the refrigerator

Fan

The fan contributes to an even distribution of air inside the refrigerator

Refrigerant gas R600a

Environmentally friendly R600a refrigerant gas contributes to rapid cooling with lower energy consumption

Life Plus 0°

Temperature-controlled Life Plus compartment for optimal storage of specific food categories

Refrigerator Internal lighting

Interior lighting for perfect visibility of shelves in the refrigerator compartment

Fruit and vegetable drawer

The fruit and vegetable drawer ensures the best storage conditions for fresh food, avoiding any contamination

Inverter compressor

Inverter compressor reduces noise and vibration levels for a quiet and comfortable kitchen environment

Inverter compressor technology offers significant advantages for refrigeration systems, improving both performance and efficiency. Better temperature control ensures a more stable and constant indoor environment, preserving the freshness of food. This technology also results in reduced energy consumption, as the compressor adjusts its speed according to cooling needs.

Internal display

Internal display for targeted temperature control and a clean, minimalist design