

## C92IPX2

Cooker size	90x60 cm
N. of cavities with energy label	2
Cavity heat source	Electric
Hob type	Induction
Type of main oven	Thermo-ventilated
Type of second oven	Static
Cleaning system main oven	Pyrolytic
EAN code	8017709329716
Energy efficiency class	A
Energy efficiency class, second cavity	A



## Aesthetics











<b>Design</b>	Square design	<b>Control knobs</b>	Smeg Classic
<b>Command panel finish</b>	Enamelled metal	<b>Controls colour</b>	Stainless steel
<b>Aesthetics</b>	Classic	<b>No. of controls</b>	8
<b>Logo</b>	Assembled st/steel	<b>Serigraphy colour</b>	Black
<b>Colour</b>	Stainless steel	<b>Display</b>	Touch
<b>Logo position</b>	Facia below the oven	<b>Door</b>	With 2 horizontal strips
<b>Finishing</b>	Brushed	<b>Glass type</b>	dark grey
<b>Upstand</b>	Yes	<b>Handle</b>	Smeg Classic
<b>Series</b>	Symphony	<b>Handle Colour</b>	Brushed stainless steel
<b>Hob colour</b>	Stainless steel	<b>Storage compartment</b>	Door
<b>Type of control setting</b>	Control knobs	<b>Feet</b>	Silver
<b>Slider</b>	Red		

## Programs / Functions

No. of cooking functions	9
--------------------------	---



### Traditional cooking functions

-  Static
-  Fan assisted
-  Circulaire
-  Turbo (circulaire + bottom + upper + fan)
-  ECO
-  Large grill
-  Fan grill (large)
-  Base
-  Fan assisted base

### Cleaning functions

-  Pyrolytic

## Programs / Functions Auxiliary Oven

Cooking functions cavity 2  
Bottom element + Upper element  

Traditional cooking functions, cavity 2

-  Static
-  Large grill
-  Bottom

## Hob technical features



**Total no. of cook zones** 5

Front left - Induction - multizone - 2.10 kW - Booster 2.30 kW - 21.0x19.0 cm

Rear left - Induction - multizone - 1.60 kW - Booster 1.85 kW - 21.0x19.0 cm

Central - Induction - single - 2.30 kW - Booster 3.00 kW - Ø 27.0 cm

Rear right - Induction - single - 1.20 kW - Booster 1.40 kW - Ø 18.0 cm

Front right - Induction - single - 2.30 kW - Booster 3.00 kW - Ø 21.0 cm

<b>No. of cooking zones with Booster</b>	5	<b>Automatic pan detection</b>	Yes
<b>Number of Flexible zones</b>	1	<b>Minimum pan diameter indication</b>	Yes
<b>Automatic switch off when overheat</b>	Yes	<b>Selected zone indicator</b>	Yes
<b>Automatic switch off when overflow</b>	Yes	<b>Residual heat indicator</b>	Yes



Removable inner door	Yes	Grill type	Electric
----------------------	-----	------------	----------

## Options Auxiliary Oven

Minimum Temperature	50 °C	Maximum temperature	245 °C
---------------------	-------	---------------------	--------

## Accessories included for Main Oven & Hob



Chrome shelf with back and side stop	1	Telescopic Guide rails, total Extraction	1
20mm deep tray	1	Meat Probe	1
40mm deep tray	1	Child Lock	1
Grill mesh	1		

## Accessories included for Secondary Oven

Chrome shelf with back and side stop	1	Grill mesh	1
Wide baking tray	1	Child lock	1

## Electrical Connection

Max Power Draw	12000 W	Additional connection modalities	Yes, Double and Three Phase
Current	36 A	Frequency	50/60 Hz
Voltage	220-240 V	Terminal block	5 poles
Voltage 2 (V)	380-415 V	Plug	No
Type of electric cable	Yes, Single phase		

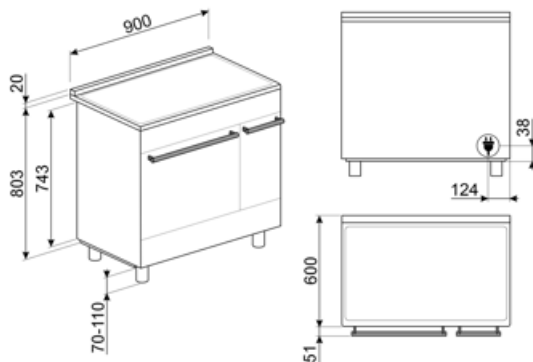

## Compatible Accessories

### AIRFRY

Air fryer rack AIRFRY. Ideal for recreating traditional frying in the oven, but with fewer calories and less fat. It allows you to cook quickly and simply dishes such as French fries, fried vegetables and fish, ensuring perfect browning and crispiness.



### BBQ

Double sided plate BBQ. Suitable for recreating succulent and crispy dishes in the oven with the typical taste of grilled cooking. The ribbed side is particularly suitable for meats and cheeses. The smooth side for fish, seafood and vegetables.



### BN640

Enamelled tray, 40mm deep



### GRILLPLATE

Universal griddle for induction, gas, ceramic and electric hobs. Non-stick surface ideal for cooking meat, cheese and vegetables. Dimensions: 410 x 240 mm.



### GTT

\*\*Totally extractable telescopic guides (1 level)\*\* Extraction: 433 mm Material: Stainless steel AISI 430 polished



### KITH900CPF9

Height extension kit, suitable for 90 cookers (codes starting CPF9, CPF92 and C92)



### KITPBX

Height reduction feet (850 mm)



### SCRP

Induction and ceramic hobs and teppanyaki scraper



### AIRFRY2

Air fryer tray. Ideal for recreating traditional frying in the oven, but with fewer calories and less fat. It allows you to cook quickly and simply dishes such as French fries, fried vegetables and fish, ensuring perfect browning and crispiness.



### BN620-1

Enamelled tray, 20mm deep



### BNP608T

Teflon-coated tray, 8mm depth, to be placed on the grid



### GTP

\*\*Partially extractable telescopic guides (1 level)\*\* Extraction: 300 mm Material: Stainless steel AISI 430 polished



### KIT600C92PX

Cover strip for hob back side, suitable for 90cm Symphony cooker with pyro oven



### KITH95CPF9

Height extension kit (950 mm), suitable for Portofino cookers



### PALPZ

Pizza shovel with fold away handle width: 315mm length : 325mm



### SFLK1

Child lock





#### SMOLD

Set of 7 silicone moulds for ice creams, ice lollies, pralines, ice cubes or to portion food. Usable from -60°C to +230°C



#### TPKPLATE



















Universal plate for induction, gas, ceramic and electric hobs. Non-stick surface ideal for cooking fish, eggs and vegetables. Dimensions: 410 X 240 mm.























#### STONE

Rectangular refractory stone. Ideal for cooking pizzas with the same results as a typical wood-fired oven. Can also be used for baking bread, focaccias and other recipes such as pies, flans or biscuits Dimensions: L42 x H1,8 x P37,5 cm.

## Symbols glossary

 <p>Automatic merge of zones for a bigger area</p>	 <p>Power booster: option allows the zone to work at full power when very intense cooking is necessary.</p>
 <p>A: Product drying performance, measured from A+++ to D / G depending on the product family</p>	 <p>Child lock: some models are fitted with a device to lock the programme/cycle so it cannot be accidentally changed.</p>
 <p>Installation in column: Installation in column</p>	 <p>Air cooling system: to ensure a safe surface temperatures.</p>
 <p>Triple glazed doors: Number of glazed doors.</p>	 <p>Quadruple glazed: Number of glazed doors.</p>
 <p>ECO-logic: option allows you to restrict the power limit of the appliance real energy saving.</p>	 <p>Enamel interior: The enamel interior of all Smeg ovens have a special antacid lining which helps keep the interior clean by reducing the amount of cooking grease adhering to it.</p>
 <p>Fan assisted base: the mix of fan and lower heating element alone allows to finish cooking foods already cooked on the surface but not internally more quickly. This system is recommended to finish cooking foods that are already well cooked on the surface, but not internally, which therefore require a moderate higher heat. Ideal for any type of food.</p>	 <p>Fan with upper and lower elements: The elements combined with the fan aim to provide more uniform heat, a similar method to conventional cooking, so pre-heat is required. Most suitable for items requiring slow cooking methods.</p>
 <p>Upper and lower element only: a traditional cooking method best suited for single items located in the centre of the oven. the top pf the oven will always be hottest. Ideal for roast, fruit cakes, bread etc.</p>	 <p>Upper and lower element only: a traditional cooking method best suited for single items located in the centre of the oven. the top pf the oven will always be hottest. Ideal for roast, fruit cakes, bread etc.</p>
 <p>Lower heating element only: This function is ideal for foods that require extra base temperature without browning, e.g. pastry dishes, pizza. Also suitable for slow cooking of stews and casseroles.</p>	 <p>Lower heating element only: This function is ideal for foods that require extra base temperature without browning, e.g. pastry dishes, pizza. Also suitable for slow cooking of stews and casseroles.</p>
 <p>Circulaire: The combination of the fan and circular element around it gives a hot air cooking method. This provides many benefits including no preheat if cook time is more than 20 minutes, no flavour transfer when cooking different foods at the same time, less energy, and shorter cook times. Good for all types of food.</p>	 <p>ECO: The combination of the grill, fan and lower element is particularly suitable for cooking small quantities of food.</p>

- |                                                                                                                                                                                                                                                                                                                            |                                                                                                                                                                                                                                                                                                                                                                                                                                                                                                                                                                                                |
|----------------------------------------------------------------------------------------------------------------------------------------------------------------------------------------------------------------------------------------------------------------------------------------------------------------------------|------------------------------------------------------------------------------------------------------------------------------------------------------------------------------------------------------------------------------------------------------------------------------------------------------------------------------------------------------------------------------------------------------------------------------------------------------------------------------------------------------------------------------------------------------------------------------------------------|
|  <p><b>Grill element:</b> Using of grill gives excellent results when cooking meat of medium and small portions, especially when combined with a rotisserie (where possible). Also ideal for cooking sausages and bacon.</p>               |  <p><b>Fan with grill element:</b> The fan reduces the fierce heat from the grill, providing an excellent method of grilling various foods, chops, steaks, sausages etc. giving even browning and heat distribution, without drying out the food. The top two levels recommended for use, and the lower part of the oven can be used to keep items warm at the same time, an excellent facility when cooking a grilled breakfast. Half grill (centre portion only) is ideal for small quantities of food.</p> |
|  <p><b>Light</b></p>                                                                                                                                                                                                                       |  <p><b>Circulaire with upper and lower elements:</b> The use of the fan with both elements allows food to be cooked quickly and effectively, ideal for large joints that require thorough cooking. It offers a similar result to rotisserie, moving the heat around the food, instead of moving the food itself, enabling any size or shape to be cooked.</p>                                                                                                                                                 |
|  <p><b>Overheat protection:</b> The safety system that automatically turns off the hob in case of overheating of the control unit.</p>                                                                                                     |  <p><b>Induction:</b> The work of these hobs is based on the principle of electromagnetic induction. The heat is generated directly in the bottom of the pan during its contact with the hob.</p>                                                                                                                                                                                                                                                                                                             |
|  <p><b>All glass inner door:</b> All glass inner door, a single flat surface which is simple to keep clean.</p>                                                                                                                           |  <p><b>The inner door glass:</b> can be removed with a few quick movements for cleaning.</p>                                                                                                                                                                                                                                                                                                                                                                                                                 |
|  <p><b>Side lights:</b> Two opposing side lights increase visibility inside the oven.</p>                                                                                                                                                |  <p><b>Automatic opening:</b> some models have Automatic opening door when the cycle is finished which is a perfect solution for handle-less kitchen units as no handle is needed. For safety reasons, the door locks automatically when the machine is in use to avoid it being opened inadvertently.</p>                                                                                                                                                                                                  |
|  <p><b>Overfill protection:</b> The special overfill protection shuts down the stove in the presence of overflow of liquids.</p>                                                                                                         |  <p><b>Pyrolytic:</b> Pyrolytic cleaning cycles can be selected as necessary to automatically clean the oven interior.</p>                                                                                                                                                                                                                                                                                                                                                                                  |
|  <p><b>Indication of residual heat:</b> After the glass ceramic hob is switched off the residual heat indicator shows which of the heating zones still remains hot. When the temperature drops below 60 ° C, the indicator goes out.</p> |  <p><b>Removable roof liner:</b> This is a perfect solution that protects the upper part of the cavity of the oven from pollution. Easy to remove for cleaning, it can be washed in the dishwasher.</p>                                                                                                                                                                                                                                                                                                     |
|  <p><b>4</b> The oven cavity has 4 different cooking levels.</p>                                                                                                                                                                         |  <p><b>5</b> The oven cavity has 5 different cooking levels.</p>                                                                                                                                                                                                                                                                                                                                                                                                                                            |
|  <p><b>Telescopic rails:</b> allow you to pull out the dish and check it without having to remove it from the oven entirely.</p>                                                                                                         |  <p><b>Electronic control:</b> Allows you to maintain temperature inside the oven with the precision 2-3 ° C. This enables to cook meals that are very sensitive to temperature changes, such as cakes, souffles, puddings.</p>                                                                                                                                                                                                                                                                             |
|  <p><b>35 lt</b> The capacity indicates the amount of usable space in the oven cavity in litres.</p>                                                                                                                                     |  <p><b>70 lt</b> The capacity indicates the amount of usable space in the oven cavity in litres.</p>                                                                                                                                                                                                                                                                                                                                                                                                        |



The touch timer display or DigiScreen guarantees simple functionality. They display the time, set programmed cooking and the minute minder timer.



Knobs control

---

## Benefit

---

### **Induction hob**

Induction offers fast cooking and precise temperature control

Through the use of suitable cookware, induction is easy to use and maintain, safe and responsive

### **Pyrolysis**

Easy oven cleaning thanks to special pyrolytic function

### **Touch control**

Easy and intuitive timer setting with a single touch

### **Storage compartment**

More space thanks to the lower compartment, ideal for storing accessories or cooking utensils

### **Circulaire**

The best cooking performances guaranteed by ventilated circular flow.

Multiple fans and heating elements guarantee the perfect aerodynamic heat flow, allowing homogeneous and quicker cooking inside the cavity.

### **Multilevel cooking**

Several cooking levels allow maximum flexibility of use

### **Multilevel halogen light**

Internal halogen lighting on different levels guarantees excellent visibility

### **Removable inner glass**

Internal door glasses are easily removable for complete cleaning

### **Tangential cooling**

New cooling system with tangential fan and airflow from the door to the splashback

### **Telescopic guides**

Easy extraction and safe insertion of trays into the oven thanks to telescopic guides

### **Adjustable height**

Cooker top flushed with the working area thanks to adjustable feet

### **AirFry (AIRFRY optional accessory)**

Lighter and tastier food thanks to airfry basket

#### **Cold door**

During any function, the external door glass is cold, avoiding any risk of burns

#### **Pizza stone (optional accessory)**

Baking with refractory stone for soft and crispy pizza and yeast products (STONE optional accessory)

#### **BBQ (optional accessory)**

Barbeque cooking directly in the oven with the double-sided grill

#### **Isothermic Cavity**

The best cooking performance at the highest energy efficiency

#### **Single turbine**

The oven has a fan equipped with a circular heating element allowing cooking with rotating heat