

## C92IPX2

Categorie fornuis	90x60 cm
N. of cavities with energy label	2
Cavity heat source	Elektriciteit
Type kookplaat	Inductie
Type primaire oven	Thermogeventileerd
Type secundaire oven	Statisch
Reinigingssysteem primaire oven	Pyrolyse reiniging
EAN-code	8017709329716
Energie-efficiëntieklasse	A
Energie-efficiëntieklasse, tweede oven	A



## Design



<b>Design</b>	Squadrato	<b>Bedieningsknoppen</b>	Smeg Classici
<b>Afwerking bedieningspaneel</b>	Gekleurd plaatstaal	<b>Kleur bedieningsknoppen</b>	Inox
<b>Design</b>	Classici	<b>Aantal bedieningsknoppen</b>	8
<b>Logo</b>	Assembled st/steel	<b>Kleur serigrafie</b>	Zwart
<b>Kleur</b>	Inox	<b>Display</b>	DigiScreen
<b>Positie logo</b>	Strook onder de oven	<b>Deur</b>	Met 2 horizontale stroken
<b>Afwerking</b>	Geborsteld inox	<b>Type glas</b>	Eclipse zwart glas
<b>Upstand</b>	Ja	<b>Handgreep</b>	Smeg Classici
<b>Series</b>	Sinfonia	<b>Kleur handgreep</b>	Geborsteld inox
<b>Kleur kookplaat</b>	Inox	<b>Opbergruimte</b>	Opbergvak met klep
<b>Bediening</b>	Bedieningsknoppen	<b>Pootjes</b>	Zilver
<b>Kleur LED</b>	Rood		

## Programma's / Functies

Aantal kookfuncties	9
---------------------	---

## Traditionele bereidingsfuncties

Statisch	Geventileerd	Circulatie (ventilator + circulaire)
Turbo	ECO	Grote grill
Ventilator + grote grill	Onderwarmte	Geventileerde onderwarmte

## Reinigingsfuncties

Pyrolyse
----------

## Programma's / Functies secundaire oven

Aantal kookfuncties	3
Onderwarmte + bovenwarmte	

### Traditionele bereidingsfuncties, 2e oven

Statisch	Grote grill	Onderwarmte
----------	-------------	-------------

## Technische specificaties kookplaat



### Totaal aantal kookzones 5

- Linksvoor - Inductie - Multizone - 2.10 kW - Booster 2.30 kW - 21.0x19.0 cm
- Linksachter - Inductie - Multizone - 1.60 kW - Booster 1.85 kW - 21.0x19.0 cm
- Midden - Inductie - enkel - 2.30 kW - Booster 3.00 kW - Ø 27.0 cm
- Rechtsachter - Inductie - enkel - 1.20 kW - Booster 1.40 kW - Ø 18.0 cm
- Rechtsvoor - Inductie - enkel - 2.30 kW - Booster 3.00 kW - Ø 21.0 cm

Aantal kookzones met booster	5	Automatische aanpassing panafmeting	Ja
Number of Flexible zones	1	Indicator minimaal te gebruiken diameter	Ja
Automatisch uitschakelen i.g.v. oververhitting	Ja	Indicator geselecteerde zone	Ja
Automatisch uitschakelen i.g.v. overkoken	Ja	Indicator (lampje) restwarmte	Ja

## Technische specificaties primaire oven



Aantal lampen	1	Uitneembaar glas binnendeur	Ja
---------------	---	-----------------------------	----

<b>Aantal ventilatoren</b>	1		
<b>Netto volume 1e oven</b>	70 l	<b>Aantal ruiten ovendeur</b>	4
<b>Bruto volume, oven 1</b>	79 l	<b>Aantal thermo-reflecterende ruiten</b>	3
<b>Materiaal ovenruimte</b>	Ever Clean emaille	<b>Veiligheidsthermostaat</b>	Ja
<b>Aantal kookniveaus</b>	5	<b>Automatische uitschakeling</b>	Ja
<b>Type ovenrekken</b>	Metalen zijsteunen	<b>verhittingselementen bij openen deur</b>	
<b>Uitneembare bovenplaat</b>	Ja	<b>Koelsysteem</b>	Mantelkoeling
<b>Type licht</b>	Halogeen	<b>Deurblokkering tijdens pyrolyse</b>	Ja
<b>Vermogen lamp</b>	40 W	<b>Afmetingen bruikbare interne ovenruimte (hxbxd)</b>	360X460X425 mm
<b>Opties bereidingstijdprogrammering</b>	Begin en eind	<b>Temperatuurregeling</b>	Elektro-mechanisch
<b>Automatische inschakeling verlichting bij openen deur</b>	Ja	<b>Onderwarmte - vermogen</b>	1200 W
<b>Opening deur</b>	Neerwaarts	<b>Bovenwarmte - vermogen</b>	1000 W
<b>Uitneembare ovendeur</b>	Ja	<b>Grill - vermogen</b>	1700 W
<b>Volledig glazen binnendeur</b>	Ja	<b>Grote vlakgrill - vermogen</b>	2700 W
		<b>Circulatie - vermogen</b>	2000 W
		<b>Grill type</b>	Elektrisch

## Opties primaire oven

<b>Timer</b>	Ja	<b>Minimum temperatuur</b>	50 °C
<b>Geluidssignaal einde kooktijd</b>	Ja	<b>Maximum temperatuur</b>	260 °C

## Technische specificaties secundaire oven



<b>Netto volume 2e oven</b>	35 l	<b>Aantal ruiten ovendeur</b>	3
<b>Bruto volume, oven 2</b>	36 l	<b>Aantal thermo-reflecterende ruiten</b>	1
<b>Materiaal ovenruimte</b>	Ever Clean emaille	<b>Veiligheidsthermostaat</b>	Ja
<b>Aantal kookniveaus</b>	4	<b>Koelsysteem</b>	Mantelkoeling
<b>Type ovenrekken</b>	Metalen zijsteunen	<b>Afmetingen bruikbare interne ovenruimte (hxbxd)</b>	311x206x418 mm
<b>Aantal lampen</b>	1	<b>Temperatuurregeling</b>	Elektro-mechanisch
<b>Type lamp</b>	Gloeilamp	<b>Onderwarmte - vermogen</b>	700 W
<b>Vermogen lamp</b>	25 W	<b>Bovenwarmte - vermogen</b>	600 W
<b>Opening deur</b>	Neerwaarts	<b>Grill - vermogen</b>	1300 W
<b>Uitneembare ovendeur</b>	Ja	<b>Grote vlakgrill - vermogen</b>	1900 W
<b>Volledig glazen binnendeur</b>	Ja		
<b>Uitneembaar glas binnendeur</b>	Ja		

Type grill

Elektrisch

## Opties secundaire oven

Minimum temperatuur 50 °C

Maximum temperatuur 245 °C

## Meegeleverde accessoires primaire oven en kookplaat



Ovenrooster met stop	1	Telescopische geleiders, volledig uitschuifbaar	1
Bakplaat (20 mm)	1	Temperatuursonde	1
Bakplaat (40 mm)	1	Kinderbeveiliging	1
Inzetrooster	1		

## Meegeleverde accessoires secundaire oven

Ovenrooster met stop	1	Inzetrooster	1
Bakplaat	1	Kinderbeveiliging	1

## Elektrische aansluiting

Nominale aansluitwaarde	12000 W	Type stroomkabel	Double and Three Phase
Stroom	36 A	Frequentie	50/60 Hz
Spanning	220-240 V	Connection box	5 polig
Spanning 2 (V)	380-415 V	Stekker	Nee
Electric cable	Installed, Single phase		

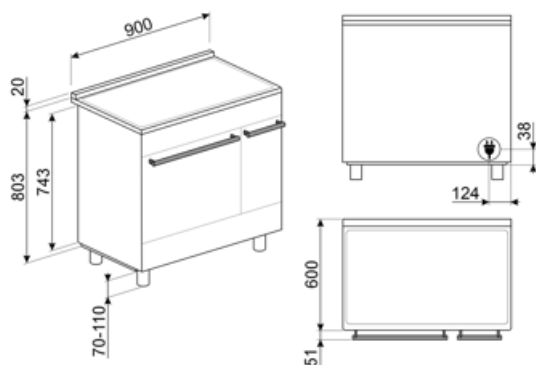

## Compatible Accessories

### AIRFRY



### BBQ

Dubbelzijdig



### BN640

Enamelled tray suitable for 45cm and 60cm ovens. Depth 540 mm. Perfect for cooking and roasting meat and fish in sauces. Also ideal for experimenting with lighter and crunchy side dishes



### GRILLPLATE

Universal griddle for induction, gas, ceramic and electric hobs. Non-stick surface ideal for cooking meat, cheese and vegetables. Dimensions: 410 x 240 mm.



### GTT

Volledig uitschuifbare telescopische rails (1 niveau) voor traditionele ovens (SF-).



### KITH900CPF9

Plinth, 90cm, three sides, black, suitable for CPF9 Portofino or Sinfony C9 cookers



### KITPBX

Height reduction feet (850mm), st/steel, for Sinfonia and Master cookers (845-856mm)



### SCRP

Schraper voor inductie- en vitrokeramische kookplaten



### AIRFRY2

Air fryer tray. Ideal for recreating traditional frying in the oven, but with fewer calories and less fat. It allows you to cook quickly and simply dishes such as French fries, fried vegetables and fish, ensuring perfect browning and crispiness.



### BN620-1

Enamelled tray suitable for 45 cm and 60 cm ovens. Depth 20 mm. Perfect for a wide range of savoury and sweet baking.



### BNP608T

Teflon bakplaat, 8mm diep



### GTP

Partially extractable telescopic guides (1 level), suitable for traditional ovens. Made in stainless steel, they guarantee stability and facilitate the smooth extraction of the trays.



### KIT600C92PX

Cover strip for hob back side, suitable for 90cm Symphony cooker with pyro oven



### KITH95CPF9

Height extension kit with plinth, (950mm), three sides, black with feet, suitable for CPF9 Portofino and Sinfony C9 cookers



### PALPZ

Pizzapallet inox met ploibaar handvat, 315x325 mm



### SFLK1

Child lock





### SMOLD

Set van 7 siliconen vormen voor ijsjes, pralines, ijsblokjes of porties. -60°C tot 230°C.



### TPKPLATE





Universal plate for induction, gas, ceramic and electric hobs. Non-stick surface ideal for cooking fish, eggs and vegetables. Dimensions: 410 X 240 mm.





















### STONE

Rectangular refractory stone Ideal for cooking pizzas with the same results as a typical wood-fired oven. Can also be used for baking bread, focaccias and other recipes such as pies, flans or biscuits Dimensions:L42 x H1,8 x P37,5 cm.

## Symbols glossary

 <p>Energy efficiency class A</p>	 <p>Power booster: option allows the zone to work at full power when very intense cooking is necessary.</p>
 <p>Sommige modellen zijn voorzien van een functie om het programma/de cyclus te blokkeren zodat het niet per ongeluk kan aangepast worden.</p>	 <p>Installation in column: Installation in column.</p>
 <p>Air cooling system: to ensure a safe surface temperatures.</p>	 <p>Triple glazed doors: Number of glazed doors.</p>
 <p>Quadruple glazed: Number of glazed doors.</p>	 <p>ECO-logic: option allows you to restrict the power limit of the appliance real energy saving.</p>
 <p>Ever Clean Enamel: Ever Clean enamel is applied electrostatically, corner to corner and edge to edge to prevent cracking or cracks over time. It is a particular pyrolytic enamel, resistant to acids which, in addition to being pleasantly bright, promotes greater cleaning of the oven walls, thanks to its lower porosity. It is baked at over 850 °C and slowly polymerized at a scientifically determined rate to ensure uniform depth and strength. Ever Clean enamel creates an impeccable finish both on the inside of the oven and on the trays, making the surfaces of the oven incredibly easy to maintain over time as it reduces the adhesion of fat during cooking.</p>	 <p>Circogas: In gasovens verdeelt de ventilator de warmte snel en gelijkmatig over de ovenruimte, waardoor smaakoverdracht wordt vermeden bij het tegelijkertijd bereiden van een aantal verschillende gerechten. In elektrische ovens voltooit deze combinatie het koken van voedsel dat aan de oppervlakte klaar is, maar dat van binnen meer moet worden gekookt, zonder verder bruin te worden.</p>
 <p>Ventilator met bovenste en onderste elementen: De elementen in combinatie met de ventilator zijn bedoeld om een meer gelijkmatige warmte te bieden, een methode die vergelijkbaar is met conventioneel koken, dus voorverwarmen is vereist. Het meest geschikt voor items die langzaam koken vereisen.</p>	 <p>Alleen boven- en onder element: een traditionele kookmethode die het meest geschikt is voor losse items in het midden van de oven. de bovenkant van de oven zal altijd het heetst zijn. Ideaal voor gebraden vlees, fruitcake, brood etc.</p>
 <p>Alleen boven- en onder element: een traditionele kookmethode die het meest geschikt is voor losse items in het midden van de oven. de bovenkant van de oven zal altijd het heetst zijn. Ideaal voor gebraden vlees, fruitcake, brood etc.</p>	 <p>Base: the heat comes only from the bottom of the cavity. The fan is not active. Ideal for sweet and savory pies, cobblers and pizzas. Designed to complete cooking and make food more crunchy. This symbol in gas ovens indicates the gas burner.</p>
 <p>Base: the heat comes only from the bottom of the cavity. The fan is not active. Ideal for sweet and savory pies, cobblers and pizzas. Designed to complete cooking and make food more crunchy This symbol in gas ovens indicates the gas burner.</p>	 <p>Circulaire: De combinatie van de ventilator en het ronde element eromheen zorgt voor een hete lucht kookmethode. Dit biedt vele voordelen, waaronder geen voorverwarmen als de kooktijd meer dan 20 minuten bedraagt, geen smaakoverdracht bij het gelijktijdig bereiden van verschillende soorten voedsel, minder energie en kortere kooktijden. Geschikt voor alle soorten voedsel.</p>

- |   |   |
|---|---|
|  De combinatie van de grill, de ventilator en onderwarmte is interessant voor het bereiden van kleine hoeveelheden.   |  Grill: Very intense heat coming only from above from a double heating element. The fan is not active. Provides excellent grilling and gratinating results. Used at the end of cooking, it gives a uniform browning to dishes. |
|  Fan grill: very intense heat coming only from above from a double heating element. The fan is active. It allows the optimal grilling of thickest meats. Ideal for large cuts of meat.  |  Light   |
|  Circulaire met bovenste en onderste elementen: door het gebruik van de ventilator met beide elementen kan voedsel snel en effectief worden gekookt, ideaal voor grote stukken vlees die grondig moeten worden gekookt. Het biedt een vergelijkbaar resultaat als rotisserie, waarbij de warmte rond het voedsel wordt verplaatst in plaats van het voedsel zelf te verplaatsen, waardoor elke maat of vorm kan worden gekookt. |  Overheat protection: The safety system that automatically turns off the hob in case of overheating of the control unit.   |
|  Induction: The work of these hobs is based on the principle of electromagnetic induction. The heat is generated directly in the bottom of the pan during its contact with the hob.   |  All glass inner door: All glass inner door, a single flat surface which is simple to keep clean.  |
|  The inner door glass: can be removed with a few quick movements for cleaning.  |  Side lights: Two opposing side lights increase visibility inside the oven.  |
|  Automatic opening: some models have Automatic opening door when the cycle is finished which is a perfect solution for handle-less kitchen units as no handle is needed. For safety reasons, the door locks automatically when the machine is in use to avoid it being opened inadvertently.  |  Overfill protection: The special overfill protection shuts down the stove in the presence of overflow of liquids.   |
|  PYROLYSIS - AUTOMATIC CLEANING FUNCTION: the oven heats up to a temperature approaching 500 ° C and chars grease and food residues into a fine ash that can be easily wiped off with a damp cloth. At such a high temperature, the door locks automatically for safety, while the temperature of the door remains controlled so it is safe to touch User adjustable function based on the level of dirt present in the oven. |  Indication of residual heat: After the glass ceramic hob is switched off the residual heat indicator shows which of the heating zones still remains hot. When the temperature drops below 60 ° C, the indicator goes out.   |
|  Removable roof liner: This is a perfect solution that protects the upper part of the cavity of the oven from pollution. Easy to remove for cleaning, it can be washed in the dishwasher.   |  The oven cavity has 4 different cooking levels.   |
|  The oven cavity has 5 different cooking levels.  |  Telescopic rails: allow you to pull out the dish and check it without having to remove it from the oven entirely.   |



Electronic control: Allows you to maintain temperature inside the oven with the precision 2-3 ° C. This enables to cook meals that are very sensitive to temperature changes, such as cakes, souffles, puddings.



The capacity indicates the amount of usable space in the oven cavity in litres.



The capacity indicates the amount of usable space in the oven cavity in litres.



DIGI screen display + bedieningsknoppen



Knobs control



Automatic merge of zones for a bigger area

---

## Benefit (TT)

---

### **Induction hob**

Induction offers fast cooking and precise temperature control

Through the use of suitable cookware, induction is easy to use and maintain, safe and responsive.

### **Pyrolysis**

Easy oven cleaning thanks to special pyrolytic function

### **Touch control**

Easy and intuitive timer setting with a single touch

### **Storage compartment**

More space thanks to the lower compartment, ideal for storing accessories or cooking utensils

### **True-convection**

The best cooking performances guaranteed by ventilated circular flow

Multiple fans and heating elements guarantee the perfect aerodynamic heat flow, allowing homogeneous and quicker cooking inside the cavity.

### **Multilevel cooking**

Several cooking levels allow maximum flexibility of use

### **Multilevel halogen light**

Internal halogen lighting on different levels guarantees excellent visibility

### **Removable inner glass**

Internal door glasses are easily removable for complete cleaning

### **Tangential cooling**

New cooling system with tangential fan and airflow from the door to the splashback

### **Telescopic guides**

Easy extraction and safe insertion of trays into the oven thanks to telescopic guides

### **Adjustable height**

Cooker top flushed with the working area thanks to adjustable feet

### **AirFry (AIRFRY optional accessory)**

Lighter and tastier food thanks to airfry basket (optional accessory)

**Cold door**

During any function, the external door glass is cold, avoiding any risk of burns

**Pizza stone (optional accessory)**

Baking with refractory stone for soft and crispy pizza and yeast products (STONE optional accessory)

**BBQ (optional accessory)**

Barbecue cooking directly in the oven with the double-sided grill (BBQ optional accessory)

**Isothermic Cavity**

The best cooking performance at the highest energy efficiency

**Single turbine**

The oven has a fan equipped with a circular heating element allowing cooking with rotating heat