

# C9GMX9-1

Cooker size	90x60 cm
N.º de cavidades com rótulo energético	1
Fonte de calor da cavidade	ELECTRICITY
Hob type	Gas
Tipo de forno principal	Thermo-ventilated
Sistema de limpeza no forno principal	Vapor Clean
EAN code	8017709278977
Energy efficiency class	A



## Aesthetics











<b>Aesthetic</b>	Classica	<b>Control knobs</b>	Smeg Classic
<b>Serie</b>	Sinfonia	<b>Controls colour</b>	Stainless steel
<b>Design</b>	Square design	<b>No. of controls</b>	8
<b>Colour</b>	Stainless steel	<b>Cor da serigrafia</b>	Serigrafia em preto
<b>Acabamento</b>	Satin	<b>Display</b>	Touch
<b>Command panel finish</b>	Finger friendly stainless steel	<b>Door</b>	With 2 horizontal strips
<b>Logo</b>	Logotipo aplicado	<b>Glass type</b>	eclipse
<b>Posição do logotipo</b>	Logotipo no painel abaixo do forno	<b>Handle</b>	Smeg Classic
<b>Upstand</b>	Yes	<b>Handle Colour</b>	Brushed stainless steel
<b>Cor da placa</b>	Stainless steel	<b>Storage compartment</b>	Push pull
<b>Type of pan stands</b>	Cast Iron	<b>Feet</b>	Silver
<b>Type of control setting</b>	Control knobs		

## Programs / Functions

No. of cooking functions	10
--------------------------	----

### Traditional cooking functions

 Static	 Fan assisted	 Circulaire
 Eco	 Small grill	 Large grill
 Fan grill (large)	 Base	 Fan assisted bottom
 Rotisserie		

### Other functions

 Defrost by time
--

### Recipes

No

### Cleaning functions

 Vapor clean
--

## Hob technical features



### Total no. of cook zones 6

Front left - Gas - 2UR (dual) - 4.20 kW

Rear left - Gas - AUX - 1.00 kW

Front centre - Gas - AUX - 1.00 kW

Rear centre - Gas - Semi Rapid - 1.80 kW

Front right - Gas - Semi Rapid - 1.80 kW

Rear right - Gas - Rapid - 3.00 kW

Type of gas burners Standard

Gas safety valves Yes

Automatic electronic ignition Yes

Burner caps

Matt black enamelled

## Main Oven Technical Features



<b>No. of lights</b>	2	<b>Removable inner door</b>	Yes
<b>Fan number</b>	2	<b>Total no. of door glasses</b>	3
<b>Net volume of the cavity</b>	115 l	<b>No. of thermo-reflective door glasses</b>	2
<b>Gross volume, 1st cavity</b>	129 l	<b>Safety Thermostat</b>	Yes
<b>Cavity material</b>	Ever Clean enamel	<b>Cooling system</b>	Tangential
<b>No. of shelves</b>	5	<b>Usable cavity space dimensions (HxWxD)</b>	371x724x418 mm
<b>Type of shelves</b>	Metal racks	<b>Temperature control</b>	Electro-mechanical
<b>Roof Liner</b>	No	<b>Lower heating element power</b>	1700 W
<b>Light type</b>	Halogen		
<b>Light Power</b>	40 W		
<b>Cooking time setting</b>	Start and Stop		

Light when oven door is open	Yes	Upper heating element - Power	1200 W
Door opening	Flap down	Grill element	1700 W
Removable door	Yes	Large grill - Power	2900 W
Full glass inner door	Yes	Circular heating element - Power	2 x 1550 W
		Grill type	Electric
		Soft Close system	No

## Options Main Oven

Timer	Yes	Minimum Temperature	50 °C
End of cooking acoustic alarm	Yes	Maximum temperature	260 °C

## Accessories included for Main Oven & Hob

Cast iron wok support	1	40mm deep tray	1
Moka stand	1	Grill mesh	1
Rack com batente traseiro e lateral	1	Sonda de carne	1
20mm deep tray	1		

## Electrical Connection

Plug	No	Comprimento do cabo de alimentação	120 cm
Electrical connection rating	3200 W	Frequency	50/60 Hz
Current	14 A	Bloco de terminais	3 polos
Voltage	220-240 V		

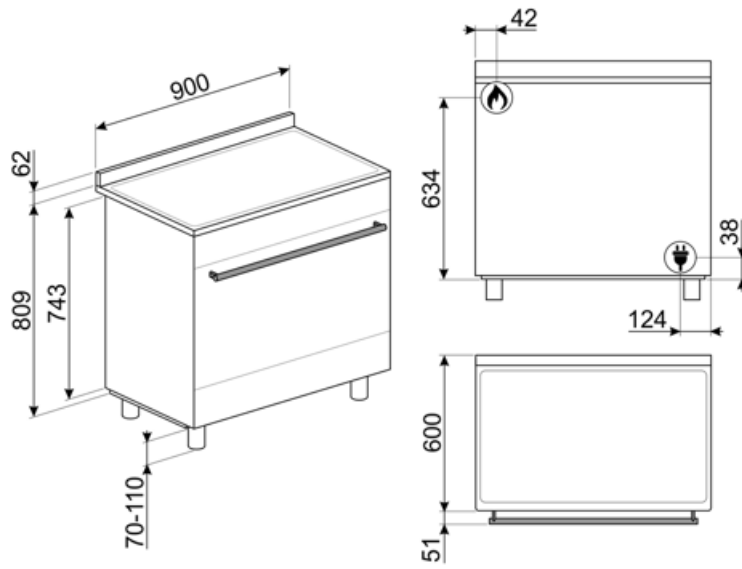

## Compatible Accessories

### AIRFRY

Air fryer rack AIRFRY . Ideal for recreating traditional frying in the oven, but with fewer calories and less fat. It allows you to cook quickly and simply dishes such as French fries, fried vegetables and fish, ensuring perfect browning and crispiness.



### BBQ

Double sided plate BBQ. Suitable for recreating succulent and crispy dishes in the oven with the typical taste of grilled cooking. The ribbed side is particularly suitable for meats and cheeses. The smooth side for fish, seafood and vegetables.



### BGTR9

Placa para grelhar de ferro fundido adequada para fogões Victoria 90 cm, Master e Sinfonia de 60 e 90 cm



### BN940

### GTT

\*\* Guias telescópicas totalmente extraíveis (1 nível)\*\* Extração: 433 mm Material: Aço inoxidável AISI 430 polido



### KITPBX

Pés de redução de altura (850 mm)

### PALPZ

Pá para pizza com alça dobrável largura: 315mm comprimento : 325mm



### SFLK1

Bloqueio para crianças



### AIRFRY9

Air fryer rack AIRFRY . Ideal for recreating traditional frying in the oven, but with fewer calories and less fat. It allows you to cook quickly and simply dishes such as French fries, fried vegetables and fish, ensuring perfect browning and crispiness.



### BBQ9



### BN920

### GTP

\*\* Guias telescópicas parcialmente extraíveis (1 nível)\*\* Extração: 300 mm Material: Aço inoxidável AISI 430 polido



### KITC9X9-1

Painel anti-salpicos, 90x75 cm, aço inoxidável, adequado para fogões Portofino, Master e Sinfonia

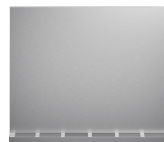

### KITROT9

Kit Rotisserie para fogões 90x60, nova cavidade (115 L)



### PPR9

Pedra para pizza refratária sem pegas. Pedra em forma quadrada: L64xH2,3xP37,5 cm Adequada também para fornos a gás, para ser colocada na grelha.







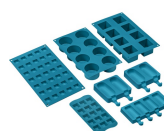























### SMOLD

Conjunto de 7 moldes de silicone para sorvetes, gelados, pralinés, cubos de gelo ou para porção de alimentos. Utilizável de -60°C a +230°C



## Symbols glossary

	Suportes de ferro fundido para serviço pesado: para máxima estabilidade e resistência.		R: Desempenho de secagem do produto, medido de A++ a D/G, dependendo da família de produtos
	Instalação em coluna: Instalação em coluna		Controle dos botões
	Sistema de arrefecimento a ar: para garantir temperaturas de superfície seguras.		Descongelar pelo tempo: com esta função, o tempo de descongelamento dos alimentos é determinado automaticamente.
	Portas envidraçadas triplas: Número de portas envidraçadas.		Interior esmaltado: O interior em esmalte de todos os fornos Smeg tem um revestimento antiácido especial que ajuda a manter o interior limpo, reduzindo a quantidade de gordura de cozimento aderente a ele.
	Aço inoxidável à prova de dedadas: O aço inoxidável à prova de dedadas mantém o aço inoxidável com um aspeto novo.		Circogas: Em fornos a gás, o ventilador distribui o calor de forma rápida e uniforme por toda a cavidade do forno, evitando a transferência de sabor ao cozinhar vários pratos diferentes ao mesmo tempo. Em fornos elétricos, esta combinação completa o cozimento mais rapidamente de alimentos que estão prontos na superfície, mas que exigem mais cozimento no interior, sem mais escurecimento.
	Ventilador com elementos superiores e inferiores: Os elementos combinados com o ventilador visam fornecer calor mais uniforme, um método semelhante ao cozimento convencional, de modo que o pré-aquecimento é necessário. Mais adequado para itens que exigem métodos de cozimento lento.		Somente elementos superior e inferior: um método de cozimento tradicional mais adequado para itens individuais localizados no centro do forno. A parte superior do forno será sempre mais quente. Ideal para assados, bolos de frutas, pão, etc.
	Apenas elemento de aquecimento inferior: Esta função é ideal para alimentos que exigem uma temperatura de base extra sem escurecimento, por exemplo, pratos de pastelaria, pizza. Também adequado para cozinhar lentamente ensopados e caçarolas.		Circulaire: A combinação do ventilador e do elemento circular em torno dele dá um método de cozimento de ar quente. Isso oferece muitos benefícios, incluindo nenhum pré-aquecimento se o tempo de cozimento for superior a 20 minutos, nenhuma transferência de sabor ao cozinhar alimentos diferentes ao mesmo tempo, menos energia e tempos de cozimento mais curtos. Bom para todos os tipos de alimentos.
	ECO: A combinação da grelha, ventilador e elemento inferior é particularmente adequada para cozinhar pequenas quantidades de alimentos.		Elemento de grelha O uso de grelha dá excelentes resultados ao cozinhar carne de porções médias e pequenas, especialmente quando combinada com uma rotisseria (sempre que possível). Também é ideal para cozinhar salsichas e bacon.

- |  |   |
|--|---|
|  <p>Meia grelha: Para cozinhar rapidamente e dourar os alimentos. Os melhores resultados podem ser obtidos usando a prateleira superior para itens pequenos, as prateleiras inferiores para os maiores, como costeletas ou salsichas. Para metade do calor da grelha é gerado apenas no centro do elemento, por isso é ideal para quantidades menores.</p> |  <p>Ventilador com elemento de grelha: O ventilador reduz o calor feroz da grelha, proporcionando um excelente método de grelhar vários alimentos, costeletas, bifés, salsichas, etc. dando o mesmo escurecimento e distribuição de calor, sem secar os alimentos. Os dois níveis superiores recomendados para uso e a parte inferior do forno podem ser usados para manter os itens quentes ao mesmo tempo, uma excelente facilidade ao cozinhar um café da manhã grelhado. Meia grelha (apenas porção central) é ideal para pequenas quantidades de alimentos.</p> |
|  <p>Rotisseria: A rotisseria (quando instalada) funciona em combinação com o elemento de grelha para alimentos assados com perfeição.</p>  |  <p>Toda a porta interna de vidro: Toda a porta interna de vidro, uma única superfície plana que é simples de manter limpa.</p>  |
|  <p>O vidro interior da porta: pode ser removido com alguns movimentos rápidos para limpeza.</p>   |  <p>Luzes laterais: Duas luzes laterais opostas aumentam a visibilidade dentro do forno.</p>   |
|  <p>Abertura automática: alguns modelos têm porta de abertura automática quando o ciclo é terminado, o que é uma solução perfeita para unidades de cozinha sem alça, pois nenhuma alça é necessária. Por razões de segurança, a porta trava automaticamente quando a máquina está em uso para evitar que seja aberta inadvertidamente.</p>                 |  <p>O compartimento do forno tem 5 níveis de cozimento diferentes.</p>   |
|  <p>Queimadores ultrarrápidos: Queimadores ultrarrápidos potentes oferecem até 5kw de potência.</p>  |  <p>Limpeza a Vapor: uma função de limpeza simples que utiliza vapor para afrouxar os depósitos no compartimento do forno.</p>   |
|  <p>A capacidade indica a quantidade de espaço útil no compartimento do forno em litros.</p>   |  <p>...</p>  |

## Benefit (TT)

---

### **Gas hob**

Gas provides permanent control of the heat source and the temperature change is immediate

Equipped with a thermocouple, the gas supply is cut off if the flame is extinguished for greater safety.

### **Vapor Clean**

By inserting water into a recess at the bottom of the cavity, steam is generated, which softens the residue and facilitates its removal

By inserting water into a recess at the bottom of the cavity, steam is generated, which softens the residue and facilitates its removal.

### **Touch control**

Easy and intuitive timer setting with a single touch

### **Push-pull storage compartment**

More space thanks to the lower push-pull compartment, ideal for storing accessories or cooking utensils

### **True-convection**

The best cooking performances guaranteed by ventilated circular flow

Multiple fans and heating elements guarantee the perfect aerodynamic heat flow, allowing homogeneous and quicker cooking inside the cavity.

### **Multilevel cooking**

Several cooking levels allow maximum flexibility of use

### **Multilevel halogen light**

Internal halogen lighting on different levels guarantees excellent visibility

### **Removable inner glass**

Internal door glasses are easily removable for complete cleaning

### **Tangential cooling**

New cooling system with tangential fan and airflow from the door to the splashback

### **Isothermic Cavity**

The best cooking performance at the highest energy efficiency

### **BBQ (optional accessory)**

Barbeque cooking directly in the oven with the double-sided grill (BBQ optional accessory)



---

**Pizza stone (optional accessory)**

Baking with refractory stone for soft and crispy pizza and yeast products (STONE optional accessory)

**Adjustable height**

Cooker top flushed with the working area thanks to adjustable feet

**Cold door**

During any function, the external door glass is cold, avoiding any risk of burns

**AirFry (AIRFRY optional accessory)**

Lighter and tastier food thanks to airfry basket (optional accessory)

**Double Turbine**

The oven has two fans equipped with two circular heating elements allowing cooking with rotating heat