

# CB2485U



<b>Product family</b>	Refrigerator
<b>Installation</b>	Built-in
<b>Category</b>	Bottom mount
<b>No-frost system</b>	Total
<b>Cooling type</b>	Fan-assisted refrigerator, no-frost freezer
<b>Defrost</b>	Automatic
<b>Hinge</b>	Door-to-door
<b>Hinge position</b>	Right
<b>Reversible door</b>	Yes
<b>EAN code</b>	8017709306045



## Aesthetic



<b>Material</b>	Steel	<b>Glass shelf profile color</b>	Silver
<b>Side material</b>	Steel	<b>Display</b>	LED
<b>Logo</b>	Silkscreened	<b>Display position</b>	Internal
<b>Door shelf profile color</b>	Silver		

## Refrigerator compartment features



<b>No. of adjustable shelves</b>	3	<b>Low temperature compartment</b>	Yes
<b>Number of fruit and vegetables drawers</b>	2	<b>Refrigerator lighting</b>	Yes
<b>Type of adjustable shelves</b>	Glass	<b>Refrigerator lighting</b>	LED
<b>Crisper cover</b>	Yes		

## Refrigerator Inner Door

<b>Number of adjustable door shelves</b>	2	<b>No. of bottle shelves</b>	1
--	---	------------------------------	---

## Other Refrigerator features



Accessories	Egg tray	Fan	Yes
MultiFlow	Metal		

## Freezer features

Number of drawers	3
-------------------	---

## Other Freezer features



Accessories	1 x ice box	Fast-freezing compartment	Yes
-------------	-------------	---------------------------	-----

## Other technical features



Display functions	Holiday, Fast-freezing, Fast-cooling, ECO
Fast-freezing button	Yes
Power-on light	Yes
Door open alarm	Yes
Temperature setting type	Electronic
No. of compressors	1
Refrigerant gas type	R600a
Door panel weight allowance	37 lbs
Foam agent	Cyclopentane
Maximum freezer door panel weight allowance	26 lbs

## Performance / Energy Label







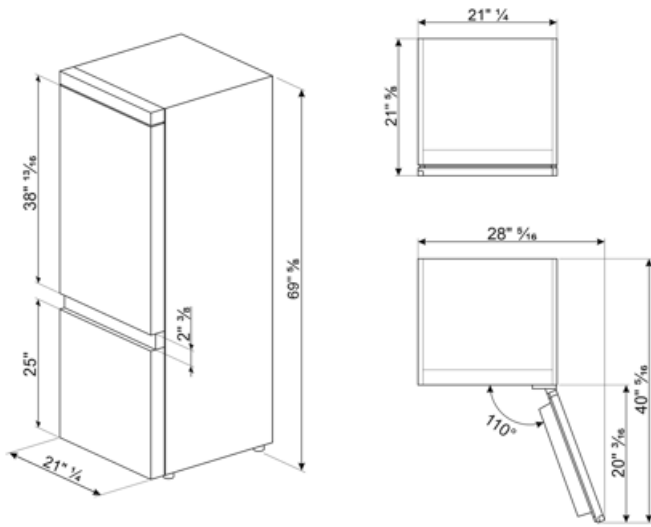



Noise level	40 dB(A) re 1 pW
-------------	------------------

## Electrical Connection

Plug	(A) USA & Mexico	Voltage (V)	115 V
Electrical connection rating	160 W	Frequency (Hz)	60 Hz
Current	0,4 A	Power cord length	70 7/8 "



## Symbols glossary

- |   |   |   |  |
|---|---|---|--|
|   | 4 stars freezing compartment for better food preservation.  |  | The automatic defrost system works by automatically defrosting at regular intervals eliminating the need to defrost altogether.            |
|   | LED display: to show programmes, functions and options selected and the time to the end of the cycle.   |  | Economical mode: Analyzes fridge functioning during the activation and optimizes the operating cycle in order to reduce power consumption. |
|   | Ventilated: Forced distribution of cold air in the refrigerator compartment, which allows even temperature distribution within the fridge.  |  | Fast freezing: The fast freezing function brings the temperature of the compartment down when activated a few hours prior to usage.        |
|   | Power saving mode: The power saving mode allows you to disable the refrigerator and keep the freezer working.   |  | LED interior lighting: is a more energy efficient and long lasting way of illuminating the interior of the appliance.                      |
|   | Built-in niche  |  | No Frost: The No Frost and Frost free systems prevent ice from forming so that no defrosting is required.                                  |
|  | Multiflow Cooling System: the Multiflow ventilation system allows an even distribution of cool air around the fridge cabinet. The stainless steel panel gives a more premium look to the appliance. |   |  |

## Benefit (TT)

---

### **Metallic Multiflow system**

The metal Multiflow system ensures an even distribution of cold air inside the refrigerator, which diffuses through an elegant stainless steel panel

A back panel with a series of openings ensures uniform circulation of cold air around each shelf of the refrigerator. This advanced air recirculation system ensures a constant temperature and humidity level, preserving food freshness for longer and helping to reduce food waste significantly

### **Fan**

The fan contributes to an even distribution of air inside the refrigerator

### **Refrigerant gas R600a**

Environmentally friendly R600a refrigerant gas contributes to rapid cooling with lower energy consumption

### **Climate class**

Climatic class SN-T makes the appliance suitable for working at room temperature between 10 °C and 43 °C (50 °F ~ 109 °F)

### **Self-supporting hinges**

Self-supporting hinges ensure a perfect fit between the equipment door and the cabinet door, giving the product a minimalist and elegant appearance

### **Refrigerator Internal lighting**

Interior lighting for perfect visibility of shelves in the refrigerator compartment

### **Fruit and vegetable drawer**

The fruit and vegetable drawer ensures the best storage conditions for fresh food, avoiding any contamination

### **Internal display**

Internal display for targeted temperature control and a clean, minimalist design