

CG90X9

Categorie fornuis	90x60 cm
N. of cavities with energy label	1
Cavity heat source	Elektriciteit
Type kookplaat	Gas
Type primaire oven	Thermogeventileerd
Reinigingssysteem primaire oven	Vapor Clean reiniging
EAN-code	8017709214173
Energie-efficiëntieklasse	A



Design



Design	Standaard	Bedieningsknoppen	Smeg Classici
Afwerking bedieningspaneel	Inox	Kleur bedieningsknoppen	Inox
Design Logo	Mixed	Aantal bedieningsknoppen	7
Logo	In reliëf	Kleur serigrafie	Zwart
Kleur	Inox	Display	Elektronisch 5 toetsen
Positie logo	Strook onder de oven	Deur	Geheel glas
Afwerking Upstand	Geborsteld inox	Type glas	Stopsol
Series	Ja	Handgreep	Smeg Tondino
Kleur kookplaat	Concerto	Kleur handgreep	Geborsteld inox
Type pottendragers	Inox	Opbergruimte	Opbergvak met klep
Bediening	Gietijzeren pottendragers	Pootjes	Zilver
	Bedieningsknoppen		

Programma's / Functies

Traditionele bereidingsfuncties

 Statisch	 Geventileerd	 Circulatie (ventilator + circulaire)
 ECO	 Grote grill	 Ventilator + grote grill
 Geventileerde onderwarmte	 Braadspit	











Reinigingsfuncties

 Vapor Clean reiniging
--

Technische specificaties kookplaat

 UR			
Totaal aantal kookzones	5		
Linksvoor - Gas - RP	2.90 kW		
Linksachter - Gas - SRD	1.80 kW		
Midden - Gas - URP	4.00 kW		
Rechtsachter - Gas - SRD	1.80 kW		
Rechtsvoor - Gas - AUX	1.00 kW		
Type gasbranders	Standaard	Thermobeveiliging	Ja
Automatische vonkontsteking	Ja	Branderdeksels	Mat zwart geëmailleerd

Technische specificaties primaire oven

         			
Netto volume 1e oven	115 l	Aantal ruiten ovendeur	3
Bruto volume, oven 1	129 l	Aantal thermo-reflecterende ruiten	2
Materiaal ovenruimte	Ever Clean emaille	Veiligheidsthermostaat	Ja
Aantal kookniveaus	5	Koelsysteem	Mantelkoeling
Type ovenrekken	Metalen zijsteunen	Afmetingen bruikbare interne ovenruimte (hxbxd)	371x724x418 mm
Type licht	Halogeen	Temperatuurregeling	Elektro-mechanisch
Vermogen lamp	40 W	Onderwarmte - vermogen	1700 W
Opties bereidingstijdprogrammering	Begin en eind	Bovenwarmte - vermogen	1200 W
Automatische inschakeling verlichting bij openen deur	Ja	Grill - vermogen	1700 W
Opening deur	Neerwaarts	Grote vlakgrill - vermogen	2900 W
Uitneembare ovendeur	Ja	Circulatie - vermogen	1550 W
Volledig glazen binnendeur	Ja		
Uitneembaar glas binnendeur	Ja		

Grill type

Elektrisch

Opties primaire oven

Timer	Ja	Minimum temperatuur	50 °C
Geluidssignaal einde kooktijd	Ja	Maximum temperatuur	260 °C

Meegeleverde accessoires primaire oven en kookplaat

Houder t.b.v. caffettiera	1	Bakplaat (40 mm)	1
Ovenrooster met stop	1	Inzetrooster	1

Elektrische aansluiting

Nominale aansluitwaarde	3200 W	Frequentie	50/60 Hz
Stroom	14 A	Connection box	3 polig
Spanning	220-240 V	Stekker	Nee
Lengte voedingskabel	120 cm		

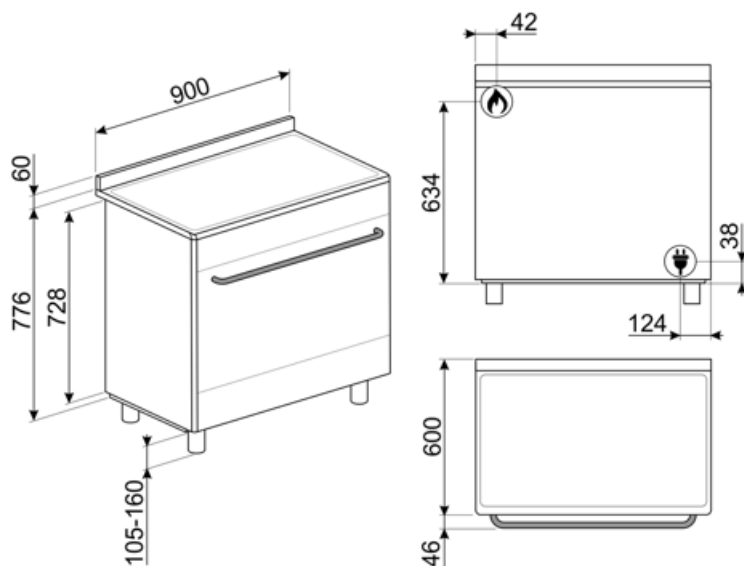

Compatible Accessories

AIRFRY9

Air fryer rack AIRFRY . Ideal for recreating traditional frying in the oven, but with fewer calories and less fat. It allows you to cook quickly and simply dishes such as French fries, fried vegetables and fish, ensuring perfect browning and crispiness.



BBQ9

teflon-coated aluminum grid for 90 cm cavity



BN940

Enamelled tray 90 cm, 40 mm deep



GTT

Volledig uitschuifbare telescopische rails (1 niveau) voor traditionele ovens (SF-).



KIT90X9-1

Splashback, stainless steel, 90cm, for Concerto cookers with single MF or gas oven



KITPDQ

Height reduction feet (850mm), stainless steel, for Concerto cookers (850-881mm)



PALPZ

Pizzapallet inox met plooibaar handvat, 315x325 mm



SMOLD

Set van 7 siliconen vormen voor ijsjes, pralines, ijsblokjes of porties. -60°C tot 230°C.

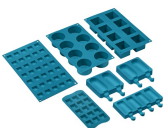

AL90X9

Upstand suitable for 90cm Concerto cookers with gas hob and MF oven



BN920

Enamelled tray 90cm cavity, 20mm deep



GTP

Partially extractable telescopic guides (1 level), suitable for traditional ovens. Made in stainless steel, they guarantee stability and facilitate the smooth extraction of the trays.



KIT600SNL-9

Cover strip for hob back side, depth 60mm, suitable for 90cm single oven Concerto cookers



KITH95

Height extension feet (950mm), stainless steel, suitable for Concerto cookers (911-966mm)



KITROT9

Rotisserie kit for 90x60 cookers, new cavity (115 L)

























SFLK1

Child lock



Symbols glossary

 <p>Heavy duty cast iron pan stands: for maximum stability and strength.</p>	 <p>Energy efficiency class A</p>
 <p>Installation in column: Installation in column.</p>	 <p>Air cooling system: to ensure a safe surface temperatures.</p>
 <p>Triple glazed doors: Number of glazed doors.</p>	 <p>Ever Clean Enamel: Ever Clean enamel is applied electrostatically, corner to corner and edge to edge to prevent cracking or cracks over time. It is a particular pyrolytic enamel, resistant to acids which, in addition to being pleasantly bright, promotes greater cleaning of the oven walls, thanks to its lower porosity. It is baked at over 850 °C and slowly polymerized at a scientifically determined rate to ensure uniform depth and strength. Ever Clean enamel creates an impeccable finish both on the inside of the oven and on the trays, making the surfaces of the oven incredibly easy to maintain over time as it reduces the adhesion of fat during cooking.</p>
 <p>Circogas: In gasovens verdeelt de ventilator de warmte snel en gelijkmatig over de ovenruimte, waardoor smaakoverdracht wordt vermeden bij het tegelijkertijd bereiden van een aantal verschillende gerechten. In elektrische ovens voltooit deze combinatie het koken van voedsel dat aan de oppervlakte klaar is, maar dat van binnen meer moet worden gekookt, zonder verder bruin te worden.</p>	 <p>Ventilator met bovenste en onderste elementen: De elementen in combinatie met de ventilator zijn bedoeld om een meer gelijkmatige warmte te bieden, een methode die vergelijkbaar is met conventioneel koken, dus voorverwarmen is vereist. Het meest geschikt voor items die langzaam koken vereisen.</p>
 <p>Alleen boven- en onder element: een traditionele kookmethode die het meest geschikt is voor losse items in het midden van de oven. de bovenkant van de oven zal altijd het heetst zijn. Ideaal voor gebraden vlees, fruitcake, brood etc.</p>	 <p>Circulaire: De combinatie van de ventilator en het ronde element eromheen zorgt voor een hete lucht kookmethode. Dit biedt vele voordelen, waaronder geen voorverwarmen als de kooktijd meer dan 20 minuten bedraagt, geen smaakoverdracht bij het gelijktijdig bereiden van verschillende soorten voedsel, minder energie en kortere kooktijden. Geschikt voor alle soorten voedsel.</p>
 <p>De combinatie van de grill, de ventilator en onderwarmte is interessant voor het bereiden van kleine hoeveelheden.</p>	 <p>Grill: Very intense heat coming only from above from a double heating element. The fan is not active. Provides excellent grilling and gratinating results. Used at the end of cooking, it gives a uniform browning to dishes.</p>
 <p>Fan grill: very intense heat coming only from above from a double heating element. The fan is active. It allows the optimal grilling of thickest meats. Ideal for large cuts of meat.</p>	 <p>Rotisserie: The rotisserie (where installed) works in combination with the grill element to brown foods to perfection.</p>
 <p>All glass inner door: All glass inner door, a single flat surface which is simple to keep clean.</p>	 <p>The inner door glass: can be removed with a few quick movements for cleaning.</p>

-
-  Side lights: Two opposing side lights increase visibility inside the oven.
 -  Automatic opening: some models have Automatic opening door when the cycle is finished which is a perfect solution for handle-less kitchen units as no handle is needed. For safety reasons, the door locks automatically when the machine is in use to avoid it being opened inadvertently.
 -  The oven cavity has 5 different cooking levels.
 -  Ultra rapid burners: Powerful ultra rapid burners offer up to 5kw of power.
 -  Vapor Clean: a simple cleaning function using steam to loosen deposits in the oven cavity.
 -  The capacity indicates the amount of usable space in the oven cavity in litres.
 -  Knobs control