

CMS4303X



Product Family	Coffee machine
Type	Automatic
Category	45 cm compact



Aesthetics





Aesthetic	Classica	Type of steel	Brushed
Colour	Stainless steel	Glass Type	Eclipse
Finishing	Fingerproof	Logo	Embossed









Controls



Display	4,3" TFT colour soft touch	No. of controls	2
No. of display languages	17	Control knobs	Classic
Display languages	IT, GB, FR, NL, SP, PT, SWE, RU, DE, DK, PL, NO, FI, TR, ET, KK, UK	Controls colour	Steel effect
Type of control setting	Touch control		

Program / Functions

N° drinks	
Coffee function (single)	
Coffee function (double)	
Pre-heat infuser function	Yes
Automatic Cappuccino maker with separate tank for milk	Yes
Hot water function: for Tea or other drinks	

Ground coffee option	
Adjustable coffee intensity	
Variable coffee length	
Adjustable cappuccino foam	
Programmed automatic switch-on	
Automatic rinsing	
Automatic descaling	
Variable coffee temperature	
Adjustable coffee grinder	
Water hardness	Yes
Lack of water signal	Yes
Child lock	Yes
Demo mode	Yes

Technical Features



Coffee granules compartment	Yes	Heating system	Thermoblock + Steamer
Ground coffee compartment	Yes	Grinder	Semiprofessional stainless steel conical grinder
Removable water container	Yes	Pump pressure	15 bar
Used coffee waste container	Yes (14 single, 7 double)	Water container capacity	2,50 l
Height-adjustable coffee spout	Yes, 85-142 mm	Coffee granule container capacity	350 g
Steam dispenser	Yes	Light Type	LED
Drip tray	Yes	Lights	4
Removable milk jug	Yes	Installation	On telescopic guides with soft closing
Thermal carafe	Yes, stainless steel 0,5 L with autoclean system	Frontal approach	Yes
Cup holder	Yes, warmed		

Electrical Connection

Plug	Not present	Voltage (V)	220-240 V
Nominal power	1350 W	Frequency (Hz)	50-60 Hz
Current	5,6 A	Power supply cable length	180 cm

Logistic Information

Width (mm)	595 mm	Height (mm)	455 mm
-------------------	--------	--------------------	--------

Depth (mm)

470 mm

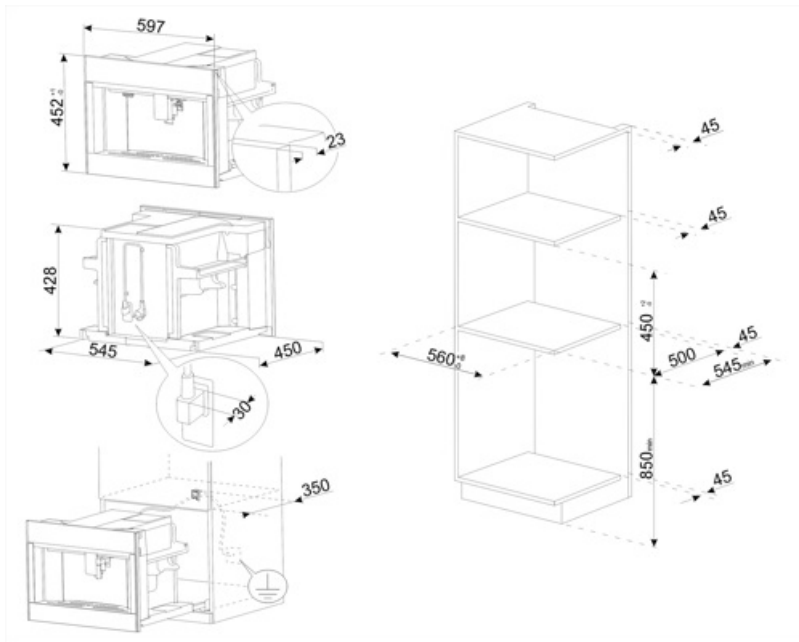

























Compatible Accessories

KITCABLE90UK

Cable with IEC connector and UK plug

Symbols glossary

 <p>Rinsing: There is an automatic rinsing with hot water when the coffee machine is switched on.</p>	 <p>Automatic switch on: It is possible to program automatic switch on of the machine to make it ready for use by the required time.</p>
 <p>Brewing temperature between 88 and 96°C.</p>	 <p>Three levels adjustable coffee temperature to taste the coffee on the temperature desired.</p>
 <p>Semiprofessional steamer with a dedicated heating element to manage the steam outlet. Suitable for recipes such as hot chocolate, punch, bombardino, vin brulé.</p>	 <p>Types of coffee: You can prepare the following types of coffee: Ristretto-Corto (small portion) / Normale (medium portion) / Lungo (large portion)</p>
 <p>The double coffee function makes possible to prepare two espresso at the same time with just one infusion cycle.</p>	 <p>Coffee beans: You can use coffee beans in the coffee machine with the possibility to adjust the coarseness of grind.</p>
 <p>Integrated cup warmer.</p>	 <p>Descaling function: Is essential to remove excess deposits of limestone in the tank and allow the proper operation of the product. The need to perform this operation is signaled by the product itself.</p>
 <p>Fingerprint proof stainless steel: Fingerprint proof stainless steel keeps stainless steel looking as good as new.</p>	 <p>Frontal approach: it is possible to reach every point in the machine and extract any components with a single hand use.</p>
 <p>Milk froth temperature 60°C.</p>	 <p>Conical stainless steel coffee grinder.</p>
 <p>Ground coffee: You can use ground coffee or coffee beans in the coffee machine with the possibility to adjust the coarseness of grind.</p>	 <p>Compact appliances with a height of 45 cm - perfect solution to meet the functional requirements of kitchen sets of small height. Available in several types and in different styles.</p>
 <p>Hot water: Coffee machine can make hot water for tea or other hot drinks</p>	 <p>5 levels adjustable coffee intensity. This function makes possible to adjust the quantity of beans grounded in any infusion cycle.</p>
 <p>Five levels adjustable coffee length: espresso, normal, long, extra long and Americano.</p>	 <p>13 levels adjustable grinder.</p>
 <p>The machine guarantees to create different drinks: espresso, coffee, long, 2 x espresso, espresso macchiato, americano, cappuccino, cappuccino mix, caffelatte, latte macchiato, hot milk, flat white, hot water.</p>	 <p>The milk froth is adjustable through the thermal carafe knob.</p>
 <p>Stainless steel thermal carafe. It guarantees to maintain longer the milk fresh. Fitted with an auto-clean system and a knob to adjust the milk froth, it can be washed in the dishwasher.</p>	 <p>Touch controls: Easy to use touch controls allow the appliance to be programmed at the touch of a button.</p>