

CMS4303X



Product familie	Automatische koffiemachine
Type	Automatisch
Categorie	45 cm



Design

Design	Classici	Type staal	Geborsteld inox
Kleur	Inox	Type glas	Eclipse zwart glas
Afwerking	Fingerproof	Logo	In reliëf









Bediening



Display	Touch bediening grafisch kleurendisplay	Aantal bedieningsknoppen	2
Aantal talen display	17	Bedieningsknoppen	Classici
Display talen	IT, GB, FR, NL, SP, PT, SWE, RU, DE, DK, PL, NO, FI, TR, ET, KK, UK	Kleur bedieningsknoppen	Inox look
Type bediening	Touch bediening		

Program / Functions

Aantal type bereidingen	
Functie 1 koffie	
Functie dubbele koffie	
Voorverwarmen	Ja
Automatische Cappuccino maker met melkreservoir	Ja
Heet water functie voor thee of andere	

Optie gemalen koffie	
Aanpasbare intensiteit koffie	
Aanpasbare grootte koffie	
Aanpasbaar Cappuccino melkschuim	
Programmeerbare automatische aan/uit functie	
Automatisch spoelen	
Automatisch ontkalken	
Aanpasbare koffietemperatuur	
Aanpasbare koffiemaler	
Water hardheid	Ja
Signaal water tekort	Ja
Kinderbeveiliging	Ja
Demo functie	Ja

Technische specificaties



Compartiment gemalen koffie	Ja	Warmte systeem	Thermoblock + stomer
Compartiment gemalen koffie	Ja	Koffie maler	Semiprofessionele inox konische molen
Uitneembaar waterreservoir	Ja	Druk	15 bar
Afvalbakje verwerkte koffie	Ja (14 enkele koffies, 7 dubbele koffies)	Volume waterreservoir	2,50 l
Koffie-uitloop aanpasbaar in hoogte	Ja, 85-142 mm	Capaciteit gemalen koffie compartiment	350 g
Stoom dispenser	Ja	Type lamp	LED
Afdruipbakje	Ja	Indicatoren (lampjes)	4
Uitneembaar melkreservoir	Ja	Installatie	Op telescopische geleiders met zachte sluiting
Thermische karaf	Inox 0,5 l met AutoClean systeem	Frontale opening	Ja
Kopjes houder	Ja, verwarmd		

Elektrische aansluiting

Stekker	Nee	Spanning (V)	220-240 V
Nominale aansluitwaarde	1350 W	Frequentie	50-60 Hz
Stroom	5,6 A	Lengte voedingskabel	180 cm

Logistieke informatie

Breedte product (mm) 595 mm

Hoogte

455 mm

Diepte product (mm) 470 mm

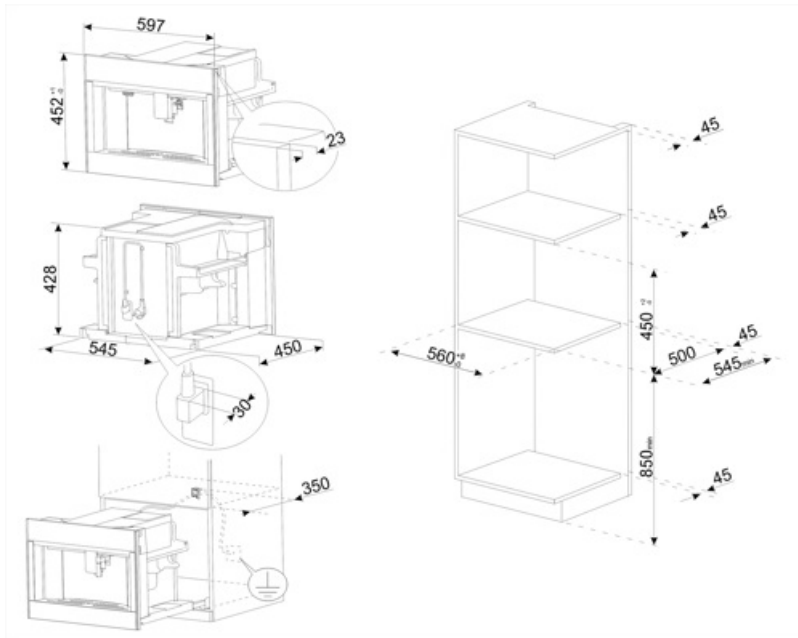

























Compatible Accessories

KITCABLE90UK

Cable with IEC connector and UK plug

Symbols glossary

 <p>Rinsing: There is an automatic rinsing with hot water when the coffee machine is switched on.</p>	 <p>Automatische inschakeling: Het is mogelijk om de automatische inschakeling van de machine te programmeren om deze op de gewenste tijd gebruiksklaar te maken.</p>
 <p>Brewing temperature between 88 and 96°C.</p>	 <p>Three levels adjustable coffee temperature to taste the coffee on the temperature desired.</p>
 <p>Semiprofessional steamer with a dedicated heating element to manage the steam outlet. Suitable for recipes such as hot chocolate, punch, bombardino, vin brulé.</p>	 <p>Types of coffee: You can prepare the following types of coffee: Ristretto-Corto (small portion) / Normale (medium portion) / Lungo (large portion).</p>
 <p>The double coffee function makes possible to prepare two espresso at the same time with just one infusion cycle.</p>	 <p>Coffee beans: You can use coffee beans in the coffee machine with the possibility to adjust the coarseness of grind.</p>
 <p>Integrated cup warmer.</p>	 <p>Ontkalkingsfunctie: Is essentieel om overtollige kalkaanslag in de tank te verwijderen en de goede werking van het product mogelijk te maken. De noodzaak om deze bewerking uit te voeren, wordt door het product zelf aangegeven.</p>
 <p>Fingerprint proof stainless steel: Fingerprint proof stainless steel keeps stainless steel looking as good as new.</p>	 <p>Frontal approach: it is possible to reach every point in the machine and extract any components with a single hand use.</p>
 <p>Milk froth temperature 60°C.</p>	 <p>Conical stainless steel coffee grinder.</p>
 <p>Ground coffee: You can use ground coffee or coffee beans in the coffee machine with the possibility to adjust the coarseness of grind.</p>	 <p>Compacte toestellen met een hoogte van 45 cm - perfecte oplossing om te voldoen aan de functionele eisen van keukensets met een kleine hoogte. Verkrijgbaar in verschillende soorten en in verschillende stijlen.</p>
 <p>Hot water: Coffee machine can make hot water for tea or other hot drinks</p>	 <p>5 levels adjustable coffee intensity. This function makes possible to adjust the quantity of beans grounded in any infusion cycle.</p>
 <p>Five levels adjustable coffee length: espresso, normal, long, extra long and Americano.</p>	 <p>13 levels adjustable grinder.</p>
 <p>The machine guarantees to create different drinks: espresso, coffee, long, 2 x espresso, espresso macchiato, americano, cappuccino, cappuccino mix, caffelatte, latte macchiato, hot milk, flat white, hot water.</p>	 <p>The milk froth is adjustable through the thermal carafe knob.</p>
 <p>Stainless steel thermal carafe. It guarantees to maintain longer the milk fresh. Fitted with an auto-clean system and a knob to adjust the milk froth, it can be washed in the dishwasher.</p>	 <p>Bediening met touch knoppen: dankzij de gebruiksvriendelijke aanraakbediening kan het apparaat met één druk op de knop worden geprogrammeerd.</p>