

# CMS4303X



|           |                      |
|-----------|----------------------|
| Familie   | Inbouw koffiemachine |
| Type      | Automatisch          |
| Categorie | 45 cm compact        |



## Design

|           |                 |                     |            |
|-----------|-----------------|---------------------|------------|
| Esthetiek | Classici        | Type roestvrijstaal | Geborsteld |
| Kleur     | Roestvrij staal | Type glas           | Zwart      |
| Afwerking | Vingervlekvrij  | Logo                | In reliëf  |

## Bediening



|                        |   |                          |          |
|------------------------|---|--------------------------|----------|
| Display                | 4,3" TFT colour soft touch  | Aantal bedieningsknoppen | 2        |
| Aantal weergaven talen | 17  | Bedieningsknoppen        | Classici |
| Weergave taal          | IT, GB, FR, NL, SP, PT, SWE, RU, DE, DK, PL, NO, FI, TR, ET, KK, UK | Kleur knoppen            | Rvs look |
| Type bediening         | Touch control   |                          |          |

## Programma's / functies

|   |    |
|---|----|
| Soorten dranken   |    |
| Koffiefunctie (één kopje)                                     |    |
| Koffiefunctie (twee kopjes)                                   |    |
| Infusiefunctie vóór het verwarmen                             | Ja |
| Automatische cappuccino functie met uitneembaar melkreservoir | Ja |
| Heet water functie (voor bijv. thee)                          |    |

|   |   |
|---|---|
| Gemalen bonen functie                     |  |
| Instelbare koffie-intensiteit             |  |
| Instelbare waterhoeveelheid               |  |
| Intensiteit cappuccinoschuim              |  |
| Automatische inschakeling programmeerbaar |  |
| Automatisch spoelen                       |  |
| Automatisch ontkalken                     |  |
| Instelbare koffietemperatuur              |  |
| Instelbare roestvrijstalen koffiemaler    |  |
| Waterhardheid                             | Ja  |
| Geen-water-signaal                        | Ja  |
| Kinderbeveiliging                         | Ja  |
| Demo stand                                | Ja  |

## Technische specificaties



|                                      |   |                       |   |
|--------------------------------------|---|-----------------------|---|
| Bonen reservoir                      | Ja  | Verwarmingssysteem    | Thermoblock + stomer                                  |
| Gemalen koffiereservoir              | Ja  | Koffie maler          | Semiprofessionele roestvrijstalen conische maalschijf |
| Uitneembaar waterreservoir           | Ja  | Pompdruksysteem       | 15 bar  |
| Afvalcontainer voor gebruikte koffie | Ja (14 enkele koffies, 7 dubbele koffies) | Inhoud waterreservoir | 2.50 l  |
| Koffietuit met hoogteverstelling     | Ja, 85-142 mm                             | Koffiebonen reservoir | 350 g   |
| Stoom dispenser                      | Ja  | Soort verlichting     | Led   |
| Opvangschaal                         | Ja  | Verlichting           | 4   |
| Uitneembare melkkan                  | Ja  | Installatie           | Op telescopische geleiders met soft close             |
| Thermokan                            | Ja, RVS 0,5 L met autoclean systeem       | Frontale opening      | Ja  |
| Kopjes houder                        | Ja, verwarmd                              |                       |   |

## Elektrische aansluiting

|                |           |                      |          |
|----------------|-----------|----------------------|----------|
| Aansluitwaarde | 1350 W    | Frequentie           | 50-60 Hz |
| Stroom         | 5,6 A     | Lengte voedingskabel | 180 cm   |
| Spanning (V)   | 220-240 V |                      |          |

## Logistieke informatie

|                 |        |                |        |
|-----------------|--------|----------------|--------|
| Breedte product | 595 mm | Hoogte product | 455 mm |
| Diepte product  | 470 mm |                |        |

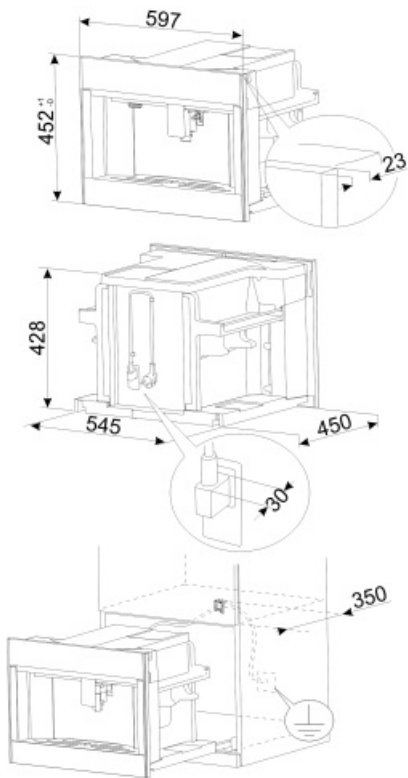

---





















## Accessoires niet inbegrepen

---

**KITCABLE90UK**

Cable with IEC connector and UK plug

## Symbols glossary (TT)

|   |  |
|---|--|
|  <p>Spoelen: er is een automatische spoeling met heet water wanneer de koffiemachine is ingeschakeld</p>  |  <p>Automatische inschakeling: Het is mogelijk om de automatische inschakeling van de machine te programmeren om deze op de gewenste tijd gebruiksklaar te maken</p>  |
|  <p>Three levels adjustable coffee temperature to taste the coffee on the temperature desired.</p>  |  <p>Semiprofessional steamer with a dedicated heating element to manage the steam outlet. Suitable for recipes such as hot chocolate, punch, bombardino, vin brulé.</p>   |
|  <p>Types of coffee: You can prepare the following types of coffee: Ristretto-Corto (small portion) / Normale (medium portion) / Lungo (large portion)</p>  |  <p>The double coffee function makes possible to prepare two espresso at the same time with just one infusion cycle.</p>  |
|  <p>Coffee beans: You can use coffee beans in the coffee machine with the possibility to adjust the coarseness of grind.</p>  |  <p>Integrated cup warmer.</p>  |
|  <p>Ontkalkingsfunctie: Is essentieel om overtollige kalksteenafzetting in de tank te verwijderen en de goede werking van het product mogelijk te maken. De noodzaak om deze handeling uit te voeren, wordt door het product zelf aangegeven.</p> |  <p>Frontal approach: it possible to reach every point in the machine and extract any components with a single hand use.</p>  |
|  <p>Conical stainless steel coffee grinder.</p>   |  <p>Ground coffee: You can use ground coffee or coffee beans in the coffee machine with the possibility to adjust the coarseness of grind.</p>  |
|  <p>Compact appliances with a height of 45 cm - perfect solution to meet the functional requirements of kitchen sets of small height. Available in several types and in different styles.</p>   |  <p>Hot water: Coffee machine can make hot water for tea or other hot drinks</p>  |
|  <p>5 levels adjustable coffee intensity. This function makes possible to adjust the quantity of beans grounded in any infusion cycle.</p>  |  <p>Five levels adjustable coffee length: espresso, normal, long, extra long and Americano.</p>   |
|  <p>13 levels adjustable grinder.</p>   |  <p>The machine guarantees to create different drinks: espresso, coffee, long, 2 x espresso, espresso macchiato, americano, cappuccino, cappuccino mix, caffelatte, latte macchiato, hot milk, flat white, hot water.</p> |
|  <p>The milk froth is adjustable through the thermal carafe knob.</p>   |  <p>Stainless steel thermal carafe. It guarantees to maintain longer the milk fresh. Fitted with an auto-clean system and a knob to adjust the milk froth, it can be washed in the dishwasher.</p>                        |
|  <p>Touch control: dankzij de gebruiksvriendelijke Touch control kan het apparaat met één druk op de knop worden geprogrammeerd.</p>  |  |