

CMS4604NR



Produktfamilie	Kaffeevollautomat
Produkttyp	Automatisch
Produktkategorie	45 cm Kompaktgerät







Ästhetik









Ästhetik	Dolce Stil Novo	Verzierung der Komponenten	Kupfer
Farbe	Schwarz	Glasart	Eclipse-Schwarzglas
Oberfläche	Hochglanz	Markenlogo	Standard

Bedienelemente

Display	4,3" TFT-Grafik-Farbdisplay mit Klartextanzeige und Piktogrammen	Display-Sprachen	IT, GB, FR, NL, SP, PT, SWE, RU, DE, DK, PL, NO, FI, TR, ET, KK, UK
Anzahl der Display-Sprachen	17	Bedienungsart	Touch-Control

Programme / Funktionen

Anzahl der Heißgetränke	
Funktion 1 Tasse Espresso/Kaffee	
Funktion 2 Tassen Espresso/Kaffee	
Vorheizfunktion	Ja
Automatische Cappuccino-Milchaufschäumung	Ja
Heißwasserfunktion für Tee und Heißgetränke	

Option Kaffeepulver	
Regelbare Kaffeestärke/Kaffeearoma	
Regelbare Wassermengen	
Regelbarer Cappuccino-Milchaufschäumer	
Programmuhr mit Auto-Start, Uhrzeitanzeige	
Automatische Spülfunktion	
Automatische Entkalkungsfunktion	
Regelbare Kaffeetemperaturen	
Regelbare Mahlgradstufen	
Wasserhärtegrad einstellbar	Ja
Wassermangelanzeige	Ja
Tastensperre/Kindersicherung	Ja
Demo-Mode Showroom-Funktion	Ja

Technische Eigenschaften



Kaffeebohnenfach	Ja	Tassenträger	beheizt
Kaffeepulverfach	Ja	Heizsystem	Doppelter Thermoblock
Wasserbehälter herausnehmbar	Ja	Mahlwerk	Edelstahl-Kegelmahlwerk
Kaffeesatzbehälter herausnehmbar	Ja	Pumpendruck	15 bar
Kaffeeauslauf höhenverstellbar	85-142 mm	Fassungsvermögen Wasserbehälter	2.40 l
Schwenkbare Heißwasser-/Dampflanze	Ja	Fassungsvermögen Kaffeebohnenfach	350 g
Restwasserschale	Ja	Art der Beleuchtung	LED
Thermo-Milchkaraffe, herausnehmbar	Ja	Beleuchtungen	4
Thermo-Milchkaraffe	0,5 l, aus Edelstahl, herausnehmbar, Autoclean-Funktion, regelbare Milchschaum-Konsistenz	Installation	Auf Teleskop-Vollauszug mit Soft-Close

Elektrischer Anschluss

Elektrischer Gesamtanschlusswert	1350 W	Frequenz	50-60 Hz
Absicherung	5.6 A	Länge des Netzkabels	180 cm
Spannung	220-240 V		

Logistik-Informationen

Produktbreite 595 mm
Produkttiefe (mm) 470 mm

Produkthöhe 455 mm

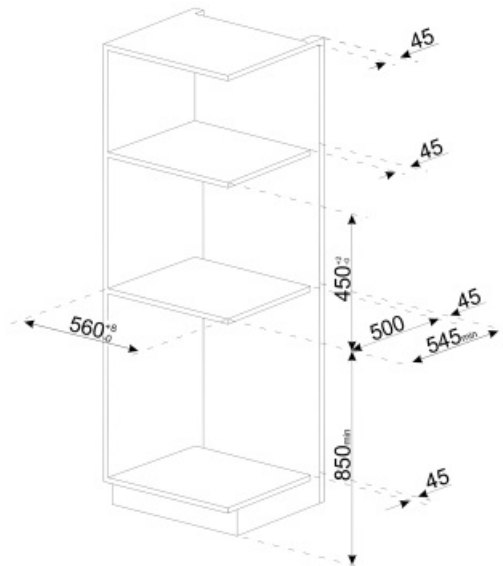
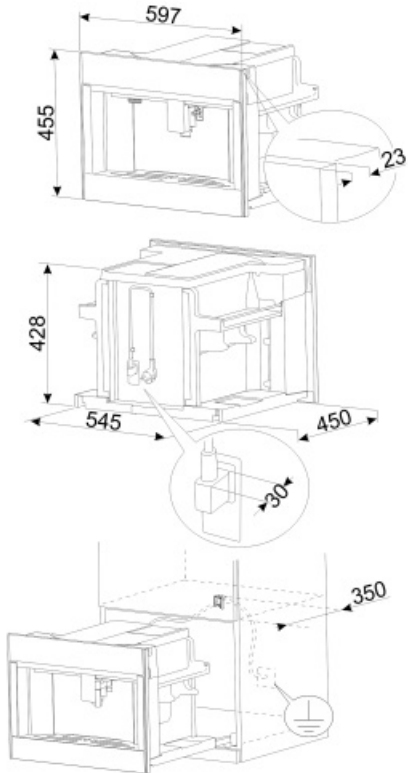





















Sonderzubehör

KITCABLE90UK

Netzkabel mit IEC-Stecksystem und UK-Netzstecker

Symbols glossary (TT)

 <p>Rinsing: There is an automatic rinsing with hot water when the coffee machine is switched on.</p>	 <p>Automatic switch on: It is possible to program automatic switch on of the machine to make it ready for use by the required time.</p>
 <p>Three levels adjustable coffee temperature to taste the coffee on the temperature desired.</p>	 <p>Semiprofessional steamer with a dedicated heating element to manage the steam outlet. Suitable for recipes such as hot chocolate, punch, bombardino, vin brulé.</p>
 <p>Types of coffee: You can prepare the following types of coffee: Ristretto-Corto (small portion) / Normale (medium portion) / Lungo (large portion)</p>	 <p>The double coffee function makes possible to prepare two espresso at the same time with just one infusion cycle.</p>
 <p>Coffee beans: You can use coffee beans in the coffee machine with the possibility to adjust the coarseness of grind.</p>	 <p>Integrated cup warmer.</p>
 <p>Entkalkungsfunktion: Ist unerlässlich, um Kalkablagerungen im Gerät zu beseitigen und die einwandfreie Funktion zu gewährleisten. Die Notwendigkeit wird durch eine Anzeige signalisiert.</p>	 <p>Conical stainless steel coffee grinder.</p>
 <p>Ground coffee: You can use ground coffee or coffee beans in the coffee machine with the possibility to adjust the coarseness of grind.</p>	 <p>Kompakte Geräte mit einer Höhe von 45 cm - die perfekte Lösung, um die funktionalen Anforderungen von Einbauküchen mit geringer Höhe zu erfüllen. Erhältlich in mehreren Ausführungen und in verschiedenen Designs.</p>
 <p>Hot water: Coffee machine can make hot water for tea or other hot drinks</p>	 <p>5 levels adjustable coffee intensity. This function makes possible to adjust the quantity of beans grounded in any infusion cycle.</p>
 <p>Five levels adjustable coffee length: espresso, normal, long, extra long and Americano.</p>	 <p>13 levels adjustable grinder.</p>
 <p>The machine guarantees to create different drinks: espresso, coffee, long, 2 x espresso, espresso macchiato, americano, cappuccino, cappuccino mix, caffelatte, latte macchiato, hot milk, flat white, hot water.</p>	 <p>The milk froth is adjustable through the thermal carafe knob.</p>
 <p>Stainless steel thermal carafe. It guarantees to maintain longer the milk fresh. Fitted with an auto-clean system and a knob to adjust the milk froth, it can be washed in the dishwasher.</p>	 <p>Touch Control: mit der benutzerfreundlichen Touch-Bedienung lässt sich das Gerät per Fingertipp sehr leicht bedienen.</p>