

CMS6451X



Product Family Coffee machine
 Type Automatic
 Category 45 cm compact



Aesthetics

Aesthetics	Classic	Type of steel	Brushed
Colour	Stainless steel	Glass Type	Eclipse
Finishing	Fingerproof	Logo	Embossed









Controls



Display	White LCD on black background (2 lines)	Control knobs	Classic
No. of display languages	13	Controls colour	Steel effect
Display languages	IT, GB, FR, NL, SP, PT, SWE, RU, DE, CZ, DK, GR, PL	No. of buttons	8
Type of control setting	Control knobs / buttons	Button colour	Steel effect
No. of controls	2		

Program / Functions

Coffee function (single)	
Coffee function (double)	
Pre-heat infuser function	Yes
Automatic Cappuccino maker with separate tank for milk	Yes
Hot water function: for Tea or other drinks	

Ground coffee option	
Adjustable coffee intensity	
Variable coffee length	
Adjustable cappuccino foam	
Programmed automatic switch-on	
Automatic rinsing	
Automatic descaling	
Variable coffee temperature	
Adjustable coffee grinder	Yes
Water hardness	Yes
Lack of water signal	Yes

Technical Features



Coffee granules compartment	Yes	Removable milk jug	Yes
Ground coffee compartment	Yes	Pump pressure	15 bar
Removable water container	Yes	Water container capacity	1.80 l
Used coffee waste container	Yes (14 single, 7 double)	Coffee granule container capacity	220 g
Height-adjustable coffee spout	Yes	Lights	2
Steam dispenser	Yes	Installation	On telescopic guides
Drip tray	Yes		

Electrical Connection

Nominal power	1350 W	Frequency (Hz)	50-60 Hz
Current	5,6 A	Power supply cable length	180 cm
Voltage (V)	220-240 V	Plug Kit	Cina

Logistic Information

Width (mm)	595 mm	Height (mm)	455 mm
Depth (mm)	380 mm		

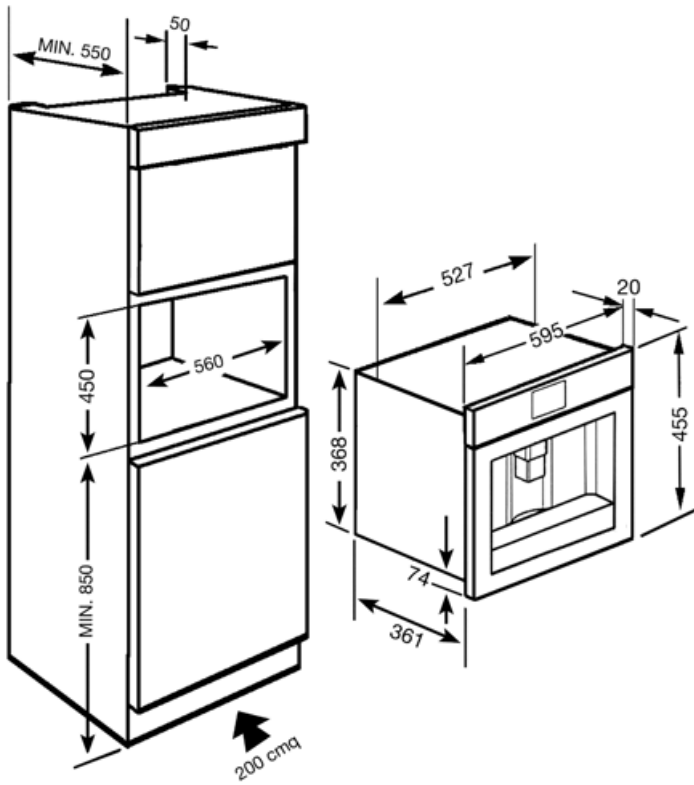

















Compatible Accessories

KITCABLE90UK

Cable with IEC connector and UK plug

Symbols glossary

 <p>Rinsing: There is an automatic rinsing with hot water when the coffee machine is switched on.</p>	 <p>Automatic switch on: It is possible to program automatic switch on of the machine to make it ready for use by the required time.</p>
 <p>Three levels adjustable coffee temperature to taste the coffee on the temperature desired.</p>	 <p>Semiprofessional steamer with a dedicated heating element to manage the steam outlet. Suitable for recipes such as hot chocolate, punch, bombardino, vin brulé.</p>
 <p>Types of coffee: You can prepare the following types of coffee: Ristretto-Corto (small portion) / Normale (medium portion) / Lungo (large portion)</p>	 <p>Types of coffee: You can prepare the following types of coffee: Ristretto-Corto (small portion) / Normale (medium portion) / Lungo (large portion)</p>
 <p>The double coffee function makes possible to prepare two espresso at the same time with just one infusion cycle.</p>	 <p>Coffee beans: You can use coffee beans in the coffee machine with the possibility to adjust the coarseness of grind.</p>
 <p>Descaling function: Is essential to remove excess deposits of limestone in the tank and allow the proper operation of the product. The need to perform this operation is signaled by the product itself.</p>	 <p>LCD display: to optimize performance and simplify the use of the appliance.</p>
 <p>Fingerprint proof stainless steel: Fingerprint proof stainless steel keeps stainless steel looking as good as new.</p>	 <p>Ground coffee: You can use ground coffee or coffee beans in the coffee machine with the possibility to adjust the coarseness of grind.</p>
 <p>Compact appliances with a height of 45 cm - perfect solution to meet the functional requirements of kitchen sets of small height. Available in several types and in different styles.</p>	 <p>Hot water: Coffee machine can make hot water for tea or other hot drinks</p>
 <p>5 levels adjustable coffee intensity. This function makes possible to adjust the quantity of beans grounded in any infusion cycle.</p>	 <p>Side lights: Two opposing side lights increase visibility inside the oven.</p>
 <p>The milk froth is adjustable through the thermal carafe knob.</p>	