

CMS6451X



Familie	Inbouw koffiemachine
Type	Automatisch
Categorie	45 cm compact



Design



Esthetiek	Classici	Type roestvrijstaal	Geborsteld
Kleur	Roestvrij staal	Type glas	Zwart
Afwerking	Vingervlekvrij	Logo	In reliëf









Bediening



Display	White LCD on black background (2 lines)	Bedieningsknoppen	Classici
Aantal weergaven talen	13	Kleur knoppen	Rvs look
Weergave taal	IT, GB, FR, NL, SP, PT, SWE, RU, DE, CZ, DK, GR, PL	Aantal knoppen	8
Type bediening	Bedieningsknoppen/ -toetsen	Kleur toetsen	Rvs look
Aantal bedieningsknoppen	2		

Program / Functions

Koffiefunctie (één kopje)	
Koffiefunctie (twee kopjes)	
Infusiefunctie vóór het verwarmen	Ja
Automatische cappuccino functie met uitneembaar melkreservoir	Ja
Heet water functie (voor bijv. thee)	

Gemalen bonen functie	
Instelbare koffie-intensiteit	
Instelbare waterhoeveelheid	
Intensiteit cappuccinoschuim	
Automatische inschakeling programmeerbaar	
Automatisch spoelen	
Automatisch ontkalken	
Instelbare koffietemperatuur	
Instelbare roestvrijstalen koffiemaler	Ja
Waterhardheid	Ja
Geen-water-signaal	Ja

Technische specificaties



Bonen reservoir	Ja	Uitneembare melkkan	Ja
Gemalen koffiereservoir	Ja	Pompdruksysteem	15 bar
Uitneembaar waterreservoir	Ja	Inhoud waterreservoir	1.80 l
Afvalcontainer voor gebruikte koffie	Ja (14 enkele koffies, 7 dubbele koffies)	Koffiebonen reservoir	220 g
Koffietuit met hoogteverstelling	Ja	Verlichting	2
Stoom dispenser	Ja	Installatie	Op telescopische geleiders met soft close
Opvangschaal	Ja		

Elektrische aansluiting

Aansluitwaarde	1350 W	Frequentie	50-60 Hz
Stroom	5,6 A	Lengte voedingskabel	180 cm
Spanning (V)	220-240 V	Stekker	Cina

Logistieke informatie

Breedte product	595 mm	Hoogte product	455 mm
Diepte product	380 mm		

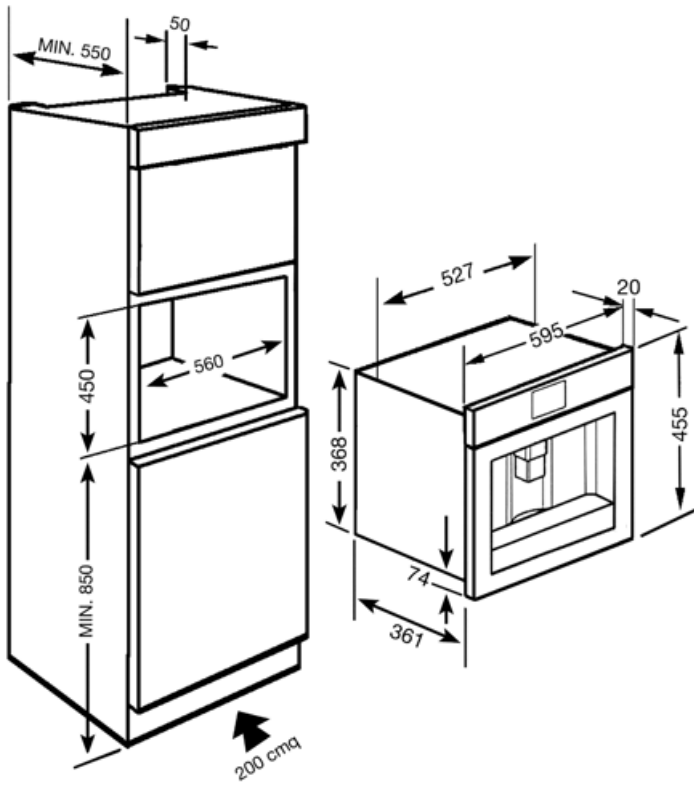

















Compatibele Accessoires

KITCABLE90UK

Cable with IEC connector and UK plug

Symbols glossary

 <p>Spoelen: er is een automatische spoeling met heet water wanneer de koffiemachine is ingeschakeld</p>	 <p>Automatische inschakeling: Het is mogelijk om de automatische inschakeling van de machine te programmeren om deze op de gewenste tijd gebruiksklaar te maken</p>
 <p>Three levels adjustable coffee temperature to taste the coffee on the temperature desired.</p>	 <p>Semiprofessional steamer with a dedicated heating element to manage the steam outlet. Suitable for recipes such as hot chocolate, punch, bombardino, vin brulé.</p>
 <p>Types of coffee: You can prepare the following types of coffee: Ristretto-Corto (small portion) / Normale (medium portion) / Lungo (large portion)</p>	 <p>Types of coffee: You can prepare the following types of coffee: Ristretto-Corto (small portion) / Normale (medium portion) / Lungo (large portion)</p>
 <p>The double coffee function makes possible to prepare two espresso at the same time with just one infusion cycle.</p>	 <p>Coffee beans: You can use coffee beans in the coffee machine with the possibility to adjust the coarseness of grind.</p>
 <p>Ontkalkingsfunctie: Is essentieel om overtollige kalksteenafzetting in de tank te verwijderen en de goede werking van het product mogelijk te maken. De noodzaak om deze handeling uit te voeren, wordt door het product zelf aangegeven.</p>	 <p>LCD-display: om de prestaties te optimaliseren en het gebruik van het apparaat te vereenvoudigen.</p>
 <p>Vingerafdrukbestendig roestvrij staal: Vingerafdrukbestendig roestvrij staal zorgt ervoor dat roestvrij staal er zo goed als nieuw uitziet.</p>	 <p>Ground coffee: You can use ground coffee or coffee beans in the coffee machine with the possibility to adjust the coarseness of grind.</p>
 <p>Compact appliances with a height of 45 cm - perfect solution to meet the functional requirements of kitchen sets of small height. Available in several types and in different styles.</p>	 <p>Hot water: Coffee machine can make hot water for tea or other hot drinks</p>
 <p>5 levels adjustable coffee intensity. This function makes possible to adjust the quantity of beans grounded in any infusion cycle.</p>	 <p>verlichting</p>
 <p>The milk froth is adjustable through the thermal carafe knob.</p>	