

CMSU2104G



Product family
Type
Category

Coffee Machine
Automatic
Compact



Aesthetic







Aesthetics	Linea	Series	2
Color	Neptune Grey	Logo	Silkscreened
Finishing	Matte		

Controls

Display	4.3" SoftTouch color	Display languages	IT, GB, FR, NL, SP, PT, SWE, RU, DE, DK, PL, NO, FI, TR, ET, KK, UK
No. of display languages	17	Control setting type	Touch controls

Program / Functions

Beverage settings	
Single coffee	
Double coffee	
Pre-heat infuser function	Yes
Automatic cappuccino maker with separate milk tank	Yes
Hot-water function	
Pre-ground coffee option	
Adjustable coffee intensity	

Variable coffee size	
Adjustable cappuccino foam	
Pre-set automatic switch-on	
Automatic rinse	
Automatic descaling	
Variable coffee temperature	
Adjustable coffee grinder	
Water hardness	Yes
Lack of water signal	Yes
Child lock	Yes
Showroom mode	Yes

Technical Features



Coffee granules compartment	Yes	Cup holder	Yes, warmed
Ground coffee compartment	Yes	Heating system	Thermoblock + Steamer
Removable water container	Yes	Coffee Grinder	Pro-style stainless steel conical grinder
Coffee grounds container	14 single, 7 double	Pump pressure	217.6 psi
Height-adjustable coffee dispenser	Yes, 3 3/8" to 5 5/8"	Water container capacity	0.7 gal
Steam dispenser	Yes	Coffee bean container capacity	12.3 oz
Drip tray	Yes	Lighting	LED
Removable milk jug	Yes	Lights	4
Thermal carafe	Stainless steel, auto-clean system, 17 fl oz capacity	Installation	On telescopic guides with soft close

Electrical Connection

Plug	No	Voltage	120 V
Nominal power	1350 W	Frequency (Hz)	60 Hz
Current	12 A	Power cord length	70 7/8 "

Logistic Information

Width	23 7/16 "	Height	17 15/16 "
Depth	18 1/2 "		

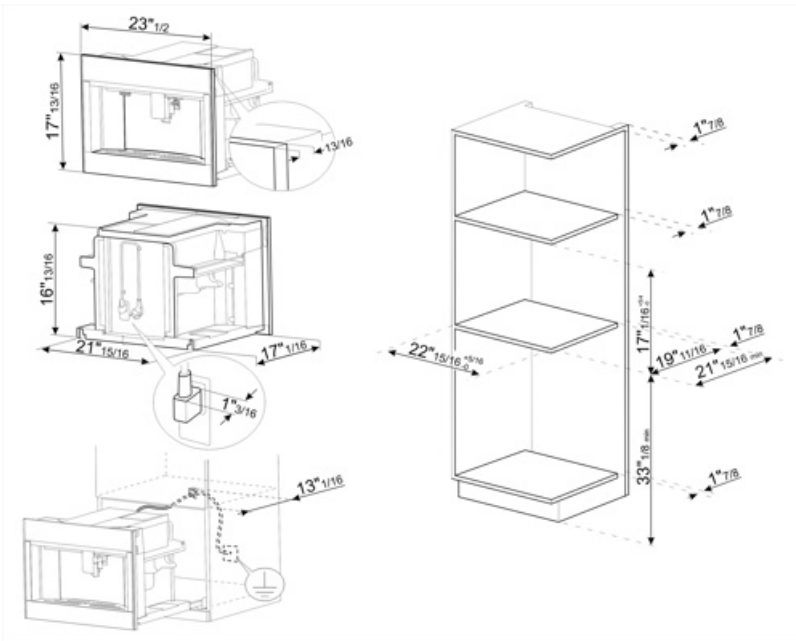























Alternative products



CMSU2304X

Color: Stainless steel

Symbols glossary

	Rinsing: There is an automatic rinsing with hot water when the coffee machine is switched on.		Automatic switch on: It is possible to program automatic switch on of the machine to make it ready for use by the required time.
	Brewing temperature between 88 and 96°C.		Three levels adjustable coffee temperature to taste the coffee on the temperature desired.
	Semiprofessional steamer with a dedicated heating element to manage the steam outlet. Suitable for recipes such as hot chocolate, punch, bombardino, vin brulé.		Types of coffee: You can prepare the following types of coffee: Ristretto-Corto (small portion) / Normale (medium portion) / Lungo (large portion)
	The double coffee function makes possible to prepare two espresso at the same time with just one infusion cycle.		Coffee beans: You can use coffee beans in the coffee machine with the possibility to adjust the coarseness of grind.
	Integrated cup warmer.		Descaling function: Is essential to remove excess deposits of limestone in the tank and allow the proper operation of the product. The need to perform this operation is signaled by the product itself.
	Frontal approach: it possible to reach every point in the machine and extract any components with a single hand use.		Milk froth temperature 60°C.
	Conical stainless steel coffee grinder.		Ground coffee: You can use ground coffee or coffee beans in the coffee machine with the possibility to adjust the coarseness of grind.
	Compact appliances with a height of 45 cm - perfect solution to meet the functional requirements of kitchen sets of small height. Available in several types and in different styles.		Hot water: Coffee machine can make hot water for tea or other hot drinks
	5 levels adjustable coffee intensity. This function makes possible to adjust the quantity of beans grounded in any infusion cycle.		Five levels adjustable coffee length: espresso, normal, long, extra long and Americano.
	13 levels adjustable grinder.		The machine guarantees to create different drinks: espresso, coffee, long, 2 x espresso, espresso macchiato, americano, cappuccino, cappuccino mix, caffelatte, latte macchiato, hot milk, flat white, hot water.
	The milk froth is adjustable through the thermal carafe knob.		Stainless steel thermal carafe. It guarantees to maintain longer the milk fresh. Fitted with an auto-clean system and a knob to adjust the milk froth, it can be washed in the dishwasher.
	Touch controls: Easy to use touch controls allow the appliance to be programmed at the touch of a button.		