

# CMSU4303X



**Product family**  
**Type**  
**Category**

Coffee machine  
Automatic  
Compact







## Aesthetic









<b>Aesthetics</b>	Classic	<b>Stainless steel type</b>	Brushed
<b>Color</b>	Stainless steel	<b>Glass</b>	Eclipse
<b>Finishing</b>	Fingerprint-proof	<b>Logo</b>	Embossed

## Controls

<b>Display</b>	4.3" SoftTouch color	<b>No. of controls</b>	2
<b>No. of display languages</b>	17	<b>Control knobs</b>	Classic
<b>Display languages</b>	IT, GB, FR, NL, SP, PT, SWE, RU, DE, DK, PL, NO, FI, TR, ET, KK, UK	<b>Control knobs color</b>	Stainless steel effect
<b>Control setting type</b>	Touch controls		

## Program / Functions

<b>Beverage settings</b>	
<b>Single coffee</b>	
<b>Double coffee</b>	
<b>Pre-heat infuser function</b>	Yes
<b>Automatic cappuccino maker with separate milk tank</b>	Yes
<b>Hot-water function</b>	

Pre-ground coffee option	
Adjustable coffee intensity	
Variable coffee size	
Adjustable cappuccino foam	
Pre-set automatic switch-on	
Automatic rinse	
Automatic descaling	
Variable coffee temperature	
Adjustable coffee grinder	
Water hardness	Yes
Lack of water signal	Yes
Child lock	Yes
Showroom mode	Yes

## Technical Features



<b>Coffee granules compartment</b>	Yes	<b>Heating system</b>	Thermoblock + Steamer
<b>Ground coffee compartment</b>	Yes	<b>Coffee grinder</b>	Pro-style stainless steel conical grinder
<b>Removable water container</b>	Yes	<b>Pump pressure</b>	217,6 psi
<b>Coffee grounds container</b>	14 single, 7 double	<b>Water container capacity</b>	0.7 gal
<b>Height-adjustable coffee dispenser</b>	Yes, 3 3/8" to 5 5/8"	<b>Coffee bean container capacity</b>	12,3 oz
<b>Steam dispenser</b>	Yes	<b>Lighting</b>	LED
<b>Drip tray</b>	Yes	<b>Lights</b>	4
<b>Removable milk jug</b>	Yes	<b>Installation</b>	On telescopic guides with soft close
<b>Thermal carafe</b>	Stainless steel, auto-clean system, 17 fl oz capacity	<b>Frontal</b>	Yes
<b>Cup holder</b>	Yes, warmed		

## Electrical Connection







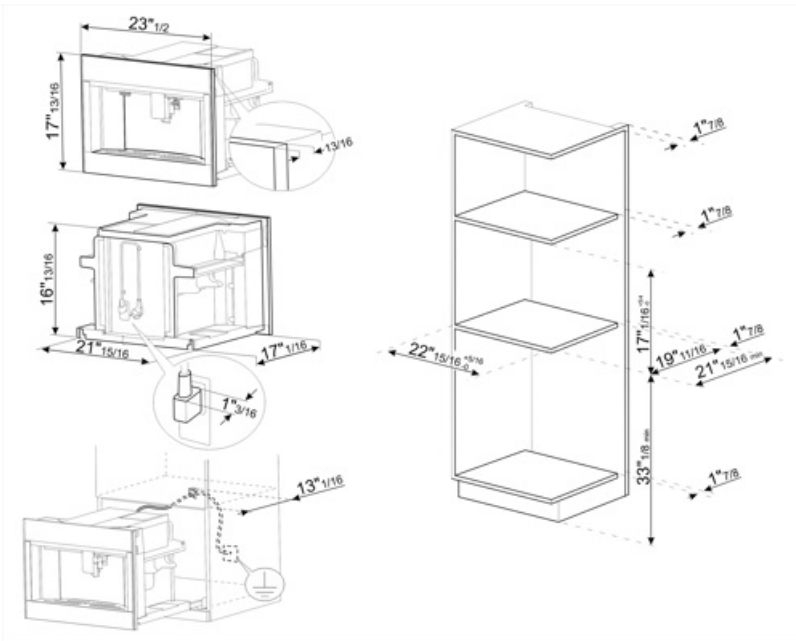

















<b>Nominal power</b>	1350 W	<b>Frequency (Hz)</b>	60 Hz
<b>Current</b>	12,2 A	<b>Power cord length</b>	70 7/8 "
<b>Voltage</b>	120 V		

## Logistic Information

<b>Width</b>	23 7/16 "	<b>Height</b>	17 15/16 "
<b>Depth</b>	18 1/2 "		



## Symbols glossary

 <p>Rinsing: There in an automatic rinsing with hot water when the coffee machine is switched on.</p>	 <p>Automatic switch on: It is possible to program automatic switch on of the machine to make it ready for use by the required time.</p>
 <p>Brewing temperature between 88 and 96°C.</p>	 <p>Three levels adjustable coffee temperature to taste the coffee on the temperature desired.</p>
 <p>Semiprofessional steamer with a dedicated heating element to manage the steam outlet. Suitable for recipes such as hot chocolate, punch, bombardino, vin brulé.</p>	 <p>Types of coffee: You can prepare the following types of coffee: Ristretto-Corto (small portion) / Normale (medium portion) / Lungo (large portion)</p>
 <p>The double coffee function makes possible to prepare two espresso at the same time with just one infusion cycle.</p>	 <p>Coffee beans: You can use coffee beans in the coffee machine with the possibility to adjust the coarseness of grind.</p>
 <p>Integrated cup warmer.</p>	 <p>Descaling function: Is essential to remove excess deposits of limestone in the tank and allow the proper operation of the product. The need to perform this operation is signaled by the product itself.</p>
 <p>Fingerprint proof stainless steel: Fingerprint proof stainless steel keeps stainless steel looking as good as new.</p>	 <p>Frontal approach: it possible to reach every point in the machine and extract any components with a single hand use.</p>
 <p>Milk froth temperature 60°C.</p>	 <p>Conical stainless steel coffee grinder.</p>
 <p>Ground coffee: You can use ground coffee or coffee beans in the coffee machine with the possibility to adjust the coarseness of grind.</p>	 <p>Compact appliances with a height of 45 cm - perfect solution to meet the functional requirements of kitchen sets of small height. Available in several types and in different styles.</p>
 <p>Hot water: Coffee machine can make hot water for tea or other hot drinks</p>	 <p>5 levels adjustable coffee intensity. This function makes possible to adjust the quantity of beans grounded in any infusion cycle.</p>
 <p>Five levels adjustable coffee length: espresso, normal, long, extra long and Americano.</p>	 <p>13 levels adjustable grinder.</p>
 <p>The machine guarantees to create different drinks: espresso, coffee, long, 2 x espresso, espresso macchiato, americano, cappuccino, cappuccino mix, caffelatte, latte macchiato, hot milk, flat white, hot water.</p>	 <p>The milk froth is adjustable through the thermal carafe knob.</p>
 <p>Stainless steel thermal carafe. It guarantees to maintain longer the milk fresh. Fitted with an auto-clean system and a knob to adjust the milk froth, it can be washed in the dishwasher.</p>	 <p>Touch controls: Easy to use touch controls allow the appliance to be programmed at the touch of a button.</p>

## Benefit (TT)

---

### **TFT Touch Display**

Intuitive and practical full-touch display for easy navigation through options and quick selection of your desired beverage

### **Favorites Function**

'Favorites' function to save and recreate preferred drinks with a single touch, customizing intensity and quantity

### **Coffee compatibility**

Compatible with both coffee beans and ground coffee, ideal for switching between blends, including decaf

### **Stainless steel conical grinder**

Stainless steel conical grinder with 13 adjustable levels for uniform grinding that preserves the full aroma

### **Thermoblock heating system**

Increased speed of machine preparation and precise control of the water temperature for coffee brewing, thanks to a thermoblock heating system

### **13 beverages**

13 different beverages with just three ingredients - coffee, milk, and water - for a varied and always perfect experience

### **Easy cleaning**

Front-accessible components for effortless cleaning and maintenance