

CPF120IGMPR

Cooker size	120x60 cm
N. of cavities with energy label	2
Cavity heat source	Electric
Hob type	Mixed
Type of main oven	Thermo-ventilated
Type of second oven	Thermo-ventilated
Cleaning system main oven	Pyrolytic
EAN code	8017709286095
Energy efficiency class	A+
Energy efficiency class, second cavity	A



Aesthetics











Design	Flush fit	Controls colour	Stainless steel
Command panel finish	Enamelled metal	No. of controls	11
Aesthetics	Portofino	Serigraphy colour	Black
Logo	Assembled st/steel	Display	Touch
Colour	Red	Door	With frame
Logo position	Facia below the oven	Glass type	Black
Upstand	Yes	Handle	Smeg Portofino
Hob colour	Stainless steel	Handle Colour	coloured
Type of pan stands	Cast Iron	Storage compartment	Drawer
Type of control setting	Control knobs	Sliding compartment	Yes
Control knobs	Smeg Portofino	Plinth	Black

Programs / Functions

No. of cooking functions	9
--------------------------	---

Traditional cooking functions

- | | | |
|--|---|---|
|  Static |  Fan assisted |  Circulaire |
|  Turbo (circulaire + bottom + upper + fan) |  ECO |  Small grill |
|  Large grill |  Fan grill (large) |  Fan assisted base |







Cleaning functions

-  Pyrolytic

Programs / Functions Auxiliary Oven

Cooking functions cavity 2 8

Traditional cooking functions, cavity 2

- | | | |
|--|--|---|
|  Static |  Fan assisted |  Circulaire |
|  ECO |  Large grill |  Fan grill (large) |
|  Fan-assisted bottom | | |

Cooking functions with Direct Steam technology

-  Thermo-ventilato (Circolare + Ventola)

Cleaning functions cavity 2

-  Vapor Clean

Hob technical features



Total no. of cook zones 6

Left centre - Gas - 2UR (dual) - 4.20 kW

Front centre - Gas - Semi Rapid - 1.80 kW

Rear centre - Gas - Rapid - 3.00 kW

Front right - Induction - multizone - 2.10 kW - Booster 2.30 kW - 21.1x19.1 cm

Rear right - Induction - multizone - 1.60 kW - Booster 1.85 kW - 21.0x19.0 cm

Central - Teppanyaki - 1.40 kW

Number of Flexible zones	1	Automatic pan detection	Yes
Type of gas burners	Standard	Minimum pan diameter indication	Yes
Automatic electronic ignition	Yes	Selected zone indicator	Yes
Burner caps	Matte black enamelled	Residual heat indicator	Yes
Automatic switch off when overheat	Yes		

Main Oven Technical Features



No. of lights	2	Total no. of door glasses	4
Fan number	1	No. of thermo-reflective door glasses	3
Net volume of the cavity	70 litres	Safety Thermostat	Yes
Gross volume, 1st cavity	79 l	Heating suspended when door is opened	Yes
Cavity material	Easy clean enamel	Cooling system	Tangential
Shelf positions	5	Door Lock During Pyrolysis	Yes
Type of shelves	Metal racks	Usable cavity space dimensions (HxWxD)	360X460X425 mm
Light type	Halogen	Temperature control	Electro-mechanical
Light power	40 W	Lower heating element power	1200 W
Cooking time setting	Start and Stop	Upper heating element - Power	1000 W
Light when oven door is open	Yes	Grill element	1700 W
Door opening	Flap down	Large grill - Power	2700 W
Removable door	Yes	Circular heating element - Power	2000 W
Full glass inner door	Yes	Grill type	Electric
Removable inner door	Yes	Soft Close system	Yes

Options Main Oven

Timer	Yes	Minimum Temperature	50 °C
End of cooking acoustic alarm	Yes	Maximum temperature	280 °C

Second Oven Technical Features



Net volume of the second cavity	63 litres	No. thermo-reflective door glasses	2
Gross volume, 2nd cavity	79 l	Safety Thermostat	Yes
Cavity material	Easy clean enamel	Heating suspended when door is opened	Yes

Shelf positions	5	Cooling system	Tangential
Type of shelves	Metal racks	Usable cavity space dimensions (HxWxD)	360X460X425 mm
No. of lights	2	Temperature control	Electro-mechanical
Light type	Halogen	Lower heating element - power	1200 W
Light power	40 W	Upper heating element - Power	1000 W
Cooking time setting	Start and Stop	Grill element - power	1700 W
Light when oven door is open	Yes	Large grill - Power	2700 W
Door opening	Flap down	Circular heating element - Power	2000 W
Removable door	Yes	Grill type	Electric
Full glass inner door	Yes	Tilting grill	Yes
Removable inner door	Yes	Soft Close system	Yes
No. total door glasses	3		

Options Auxiliary Oven

Timer	Yes	Minimum Temperature	50 °C
End of cooking acoustic alarm	Yes	Maximum temperature	260 °C

Accessories included for Main Oven & Hob



Chrome shelf with back and side stop	1	Grill mesh	1
20mm deep tray	1	Telescopic Guide rails, total Extraction	1
40mm deep tray	1	Meat Probe	1

Accessories included for Secondary Oven



Chrome shelf with back and side stop	1	Grill mesh	1
20mm deep tray	1	Telescopic Guide rails, total Extraction	1
40mm deep tray	1		

Electrical Connection

Max Power Draw	10900 W	Cable testing	Yes
Current	32 A	Additional connection modalities	Yes, Double and Three Phase
Voltage	220-240 V	Frequency	50/60 Hz
Voltage 2 (V)	380-415 V	Terminal block	5 poles
Type of electric cable	Yes, Single phase	Plug	No



Compatible Accessories

AIRFRY

Air fryer rack AIRFRY. Ideal for recreating traditional frying in the oven, but with fewer calories and less fat. It allows you to cook quickly and simply dishes such as French fries, fried vegetables and fish, ensuring perfect browning and crispiness.



BBQ

Double sided plate BBQ. Suitable for recreating succulent and crispy dishes in the oven with the typical taste of grilled cooking. The ribbed side is particularly suitable for meats and cheeses. The smooth side for fish, seafood and vegetables.



BN640

Enamelled tray, 40mm deep



GRILLPLATE

Universal griddle for induction, gas, ceramic and electric hobs. Non-stick surface ideal for cooking meat, cheese and vegetables. Dimensions: 410 x 240 mm.



GTT

Totally extractable telescopic guides (1 level) Extraction: 433 mm Material: Stainless steel AISI 430 polished



KITH95CPF120

Height extension kit (950 mm), suitable for TR4110 cookers



PALPZ

Pizza shovel with fold away handle width: 315mm length : 325mm



SFLK1

Child lock



AIRFRY2

Air fryer tray. Ideal for recreating traditional frying in the oven, but with fewer calories and less fat. It allows you to cook quickly and simply dishes such as French fries, fried vegetables and fish, ensuring perfect browning and crispiness.



BN620-1

Enamelled tray, 20mm deep



BNP608T

Teflon-coated tray, 8mm depth, to be placed on the grid



GTP

Partially extractable telescopic guides (1 level) Extraction: 300 mm Material: Stainless steel AISI 430 polished



KIT1CPF120X

Splashback 120x60 cm, stainless steel, suitable for Portofino cookers



KITP65CPF120

Depth extension kit (650 mm), suitable for TR4110 cookers



SCRP

Induction and ceramic hobs and teppanyaki scraper



SMOLD

Set of 7 silicone moulds for ice creams, ice lollies, pralines, ice cubes or to portion food. Usable from -60°C to +230°C

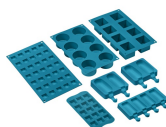



TPKPLATE

Universal plate for induction, gas, ceramic and electric hobs. Non-stick surface ideal for cooking fish, eggs and vegetables. Dimensions: 410 X 240 mm.



WOKGHU

Cast-Iron WOK Support

Alternative products



CPF120IGMPX

Colour: Stainless steel



CPF120IGMPWH

Colour: White



CPF120IGMPBL

















Colour: Black























CPF120IGMPT

Colour: Turquoise

Symbols glossary

- | | |
|---|--|
|  <p>A: Product drying performance, measured from A+++ to D / G depending on the product family</p> |  <p>A+: Energy efficiency class A+ helps to save up to 10% energy compared to class A. Maximum performance with minimum consumption is guaranteed.</p> |
|  <p>Heavy duty cast iron pan stands: for maximum stability and strength.</p> |  <p>Installation in column: Installation in column</p> |
|  <p>Air cooling system: to ensure a safe surface temperatures.</p> |  <p>A DIRECT STEAM oven has 1 steam cooking function to which the user can MANUALLY add steam. The function is activated when the user turns the function knob to the STEAM ON position, and deactivated when the user turns the steam knob to the STEAM OFF position. The user decides at the start of the cooking process how much water to load, up to 250ml. The water in the cavity then becomes steam during the cooking process.</p> |
|  <p>Triple glazed doors: Number of glazed doors.</p> |  <p>Quadruple glazed: Number of glazed doors.</p> |
|  <p>ECO-logic: option allows you to restrict the power limit of the appliance real energy saving.</p> |  <p>Enamel interior: The enamel interior of all Smeg ovens have a special antacid lining which helps keep the interior clean by reducing the amount of cooking grease adhering to it.</p> |
|  <p>Fan assisted base: the mix of fan and lower heating element alone allows to finish cooking foods already cooked on the surface but not internally more quickly. This system is recommended to finish cooking foods that are already well cooked on the surface, but not internally, which therefore require a moderate higher heat. Ideal for any type of food.</p> |  <p>Fan with upper and lower elements: The elements combined with the fan aim to provide more uniform heat, a similar method to conventional cooking, so pre-heat is required. Most suitable for items requiring slow cooking methods.</p> |
|  <p>Upper and lower element only: a traditional cooking method best suited for single items located in the centre of the oven. the top pf the oven will always be hottest. Ideal for roast, fruit cakes, bread etc.</p> |  <p>Circulaire: The combination of the fan and circular element around it gives a hot air cooking method. This provides many benefits including no preheat if cook time is more than 20 minutes, no flavour transfer when cooking different foods at the same time, less energy, and shorter cook times. Good for all types of food.</p> |
|  <p>ECO: The combination of the grill, fan and lower element is particularly suitable for cooking small quantities of food.</p> |  <p>Grill element: Using of grill gives excellent results when cooking meat of medium and small portions, especially when combined with a rotisserie (where possible). Also ideal for cooking sausages and bacon.</p> |

- | | |
|---|--|
|  <p>Half grill: For rapid cooking and browning of foods. Best results can be obtained by using the top shelf for small items, the lower shelves for larger ones, such as chops or sausages. For half grill heat is generated only at the centre of the element, so is ideal for smaller quantities.</p> |  <p>Fan with grill element: The fan reduces the fierce heat from the grill, providing an excellent method of grilling various foods, chops, steaks, sausages etc. giving even browning and heat distribution, without drying out the food. The top two levels recommended for use, and the lower part of the oven can be used to keep items warm at the same time, an excellent facility when cooking a grilled breakfast. Half grill (centre portion only) is ideal for small quantities of food.</p> |
|  <p>Circulaire with upper and lower elements: The use of the fan with both elements allows food to be cooked quickly and effectively, ideal for large joints that require thorough cooking. It offers a similar result to rotisserie, moving the heat around the food, instead of moving the food itself, enabling any size or shape to be cooked.</p> |  <p>Circulaire with steam assist: Provides extra moisture to food during cooking. Excellent for bread baking. The moisture allows the bread dough to stretch further at the beginning of cooking, creating an aerated and light textured dough. The remaining part of the cooking process allows for the signature crust to form.</p> |
|  <p>Overheat protection: The safety system that automatically turns off the hob in case of overheating of the control unit.</p> |  <p>All glass inner door: All glass inner door, a single flat surface which is simple to keep clean.</p> |
|  <p>The inner door glass: can be removed with a few quick movements for cleaning.</p> |  <p>Side lights: Two opposing side lights increase visibility inside the oven.</p> |
|  <p>Automatic opening: some models have Automatic opening door when the cycle is finished which is a perfect solution for handle-less kitchen units as no handle is needed. For safety reasons, the door locks automatically when the machine is in use to avoid it being opened inadvertently.</p> |  <p>Pyrolytic: Pyrolytic cleaning cycles can be selected as necessary to automatically clean the oven interior.</p> |
|  <p>Indication of residual heat: After the glass ceramic hob is switched off the residual heat indicator shows which of the heating zones still remains hot. When the temperature drops below 60 ° C, the indicator goes out.</p> |  <p>The oven cavity has 5 different cooking levels.</p> |
|  <p>Soft close: all models are equipped with advanced function of smooth closing of the door, which allows the device to close smoothly and quietly.</p> |  <p>Telescopic rails: allow you to pull out the dish and check it without having to remove it from the oven entirely.</p> |
|  <p>Electronic control: Allows you to maintain temperature inside the oven with the precision 2-3 ° C. This enables to cook meals that are very sensitive to temperature changes, such as cakes, souffles, puddings.</p> |  <p>Tilting grill: the tilting grill can be easily unhooked to move the heating element and clean the roof of the appliance in one simple step.</p> |
|  <p>Ultra rapid burners: Powerful ultra rapid burners offer up to 5kw of power.</p> |  <p>Vapor Clean: a simple cleaning function using steam to loosen deposits in the oven cavity.</p> |
|  <p>The capacity indicates the amount of usable space in the oven cavity in litres.</p> |  <p>The capacity indicates the amount of usable space in the oven cavity in litres.</p> |



The touch timer display or DigiScreen guarantees simple functionality. They display the time, set programmed cooking and the minute minder timer.



Knobs control



Automatic merge of zones for a bigger area

Benefit

Pyrolysis

Easy oven cleaning thanks to special pyrolytic function

Touch control

Easy and intuitive timer setting with a single touch

Drawer storage compartment

More space thanks to the lower compartment, ideal for storing accessories or cooking utensils

Circulaire

The best cooking performances guaranteed by ventilated circular flow.

Multiple fans and heating elements guarantee the perfect aerodynamic heat flow, allowing homogeneous and quicker cooking inside the cavity.

Multilevel cooking

Several cooking levels allow maximum flexibility of use

Multilevel halogen light

Internal halogen lighting on different levels guarantees excellent visibility

Removable inner glass

Internal door glasses are easily removable for complete cleaning

Tangential cooling

New cooling system with tangential fan and airflow from the door to the splashback

Telescopic guides

Easy extraction and safe insertion of trays into the oven thanks to telescopic guides

Adjustable height

Cooker top flushed with the working area thanks to adjustable feet

AirFry (AIRFRY optional accessory)

Lighter and tastier food thanks to airfry basket

Cold door

During any function, the external door glass is cold, avoiding any risk of burns

Pizza stone (optional accessory)

Baking with refractory stone for soft and crispy pizza and yeast products (STONE optional accessory)

BBQ (optional accessory)

Barbeque cooking directly in the oven with the double-sided grill

Isothermic Cavity

The best cooking performance at the highest energy efficiency

Soft close

The door is equipped with a specific system for silent closing

Single turbine

The oven has a fan equipped with a circular heating element allowing cooking with rotating heat

Direct Steam

Steam is generated from water placed in a dedicated basin at the bottom of the cavity