

# CPF120IGMPWH

Cooker size	120x60 cm
N. of cavities with energy label	2
Cavity heat source	Electric
Hob type	Mixed
Type of main oven	Thermo-ventilated
Type of second oven	Thermo-ventilated
Cleaning system main oven	Pyrolytic
EAN code	8017709286071
Energy efficiency class	A+
Energy efficiency class, second cavity	A



## Aesthetics











<b>Design</b>	Flush fit	<b>Controls colour</b>	Stainless steel
<b>Command panel finish</b>	Enamelled metal	<b>No. of controls</b>	11
<b>Aesthetics</b>	Portofino	<b>Serigraphy colour</b>	Black
<b>Logo</b>	Assembled st/steel	<b>Display</b>	Touch
<b>Colour</b>	White	<b>Door</b>	With frame
<b>Logo position</b>	Facia below the oven	<b>Glass type</b>	Black
<b>Upstand</b>	Yes	<b>Handle</b>	Smeg Portofino
<b>Hob colour</b>	Stainless steel	<b>Handle Colour</b>	White
<b>Type of pan stands</b>	Cast Iron	<b>Storage compartment</b>	Drawer
<b>Type of control setting</b>	Control knobs	<b>Sliding compartment</b>	Yes
<b>Control knobs</b>	Smeg Portofino	<b>Plinth</b>	Black

## Programs / Functions

No. of cooking functions	9
--------------------------	---

### Traditional cooking functions

- |  |   |   |
|--|---|---|
|  Static                                    |  Fan assisted      |  Circulaire        |
|  Turbo (circulaire + bottom + upper + fan) |  ECO               |  Small grill       |
|  Large grill                               |  Fan grill (large) |  Fan assisted base |







### Cleaning functions

-  Pyrolytic

## Programs / Functions Auxiliary Oven

### Cooking functions cavity 2 8

#### Traditional cooking functions, cavity 2

- |  |  |   |
|--|--|---|
|  Static              |  Fan assisted |  Circulaire        |
|  ECO                 |  Large grill  |  Fan grill (large) |
|  Fan-assisted bottom |  |   |

#### Cooking functions with Direct Steam technology



Termo-ventilato (Circolare + Ventola)

#### Cleaning functions cavity 2

-  Vapor Clean

## Hob technical features



### Total no. of cook zones 6

Left centre - Gas - 2UR (dual) - 4.20 kW

Front centre - Gas - Semi Rapid - 1.80 kW

Rear centre - Gas - Rapid - 3.00 kW

Front right - Induction - multizone - 2.10 kW - Booster 2.30 kW - 21.1x19.1 cm

Rear right - Induction - multizone - 1.60 kW - Booster 1.85 kW - 21.0x19.0 cm

Central - Teppanyaki - 1.40 kW

<b>Number of Flexible zones</b>	1	<b>Automatic pan detection</b>	Yes
<b>Type of gas burners</b>	Standard	<b>Minimum pan diameter indication</b>	Yes
<b>Automatic electronic ignition</b>	Yes	<b>Selected zone indicator</b>	Yes
<b>Burner caps</b>	Matte black enamelled	<b>Residual heat indicator</b>	Yes
<b>Automatic switch off when overheat</b>	Yes		

## Main Oven Technical Features



<b>No. of lights</b>	2	<b>Total no. of door glasses</b>	4
<b>Fan number</b>	1	<b>No. of thermo-reflective door glasses</b>	3
<b>Net volume of the cavity</b>	70 litres	<b>Safety Thermostat</b>	Yes
<b>Gross volume, 1st cavity</b>	79 l	<b>Heating suspended when door is opened</b>	Yes
<b>Cavity material</b>	Easy clean enamel	<b>Cooling system</b>	Tangential
<b>Shelf positions</b>	5	<b>Door Lock During Pyrolysis</b>	Yes
<b>Type of shelves</b>	Metal racks	<b>Usable cavity space dimensions (HxWxD)</b>	360X460X425 mm
<b>Light type</b>	Halogen	<b>Temperature control</b>	Electro-mechanical
<b>Light power</b>	40 W	<b>Lower heating element power</b>	1200 W
<b>Cooking time setting</b>	Start and Stop	<b>Upper heating element - Power</b>	1000 W
<b>Light when oven door is open</b>	Yes	<b>Grill element</b>	1700 W
<b>Door opening</b>	Flap down	<b>Large grill - Power</b>	2700 W
<b>Removable door</b>	Yes	<b>Circular heating element - Power</b>	2000 W
<b>Full glass inner door</b>	Yes	<b>Grill type</b>	Electric
<b>Removable inner door</b>	Yes	<b>Soft Close system</b>	Yes

## Options Main Oven

<b>Timer</b>	Yes	<b>Minimum Temperature</b>	50 °C
<b>End of cooking acoustic alarm</b>	Yes	<b>Maximum temperature</b>	280 °C

## Second Oven Technical Features



<b>Net volume of the second cavity</b>	63 litres	<b>No. thermo-reflective door glasses</b>	2
<b>Gross volume, 2nd cavity</b>	79 l	<b>Safety Thermostat</b>	Yes
<b>Cavity material</b>	Easy clean enamel	<b>Heating suspended when door is opened</b>	Yes

<b>Shelf positions</b>	5	<b>Cooling system</b>	Tangential
<b>Type of shelves</b>	Metal racks	<b>Usable cavity space dimensions (HxWxD)</b>	360X460X425 mm
<b>No. of lights</b>	2	<b>Temperature control</b>	Electro-mechanical
<b>Light type</b>	Halogen	<b>Lower heating element - power</b>	1200 W
<b>Light power</b>	40 W	<b>Upper heating element - Power</b>	1000 W
<b>Cooking time setting</b>	Start and Stop	<b>Grill element - power</b>	1700 W
<b>Light when oven door is open</b>	Yes	<b>Large grill - Power</b>	2700 W
<b>Door opening</b>	Flap down	<b>Circular heating element - Power</b>	2000 W
<b>Removable door</b>	Yes	<b>Grill type</b>	Electric
<b>Full glass inner door</b>	Yes	<b>Tilting grill</b>	Yes
<b>Removable inner door</b>	Yes	<b>Soft Close system</b>	Yes
<b>No. total door glasses</b>	3		

## Options Auxiliary Oven

<b>Timer</b>	Yes	<b>Minimum Temperature</b>	50 °C
<b>End of cooking acoustic alarm</b>	Yes	<b>Maximum temperature</b>	260 °C

## Accessories included for Main Oven & Hob



<b>Chrome shelf with back and side stop</b>	1	<b>Grill mesh</b>	1
<b>20mm deep tray</b>	1	<b>Telescopic Guide rails, total Extraction</b>	1
<b>40mm deep tray</b>	1	<b>Meat Probe</b>	1

## Accessories included for Secondary Oven



<b>Chrome shelf with back and side stop</b>	1	<b>Grill mesh</b>	1
<b>20mm deep tray</b>	1	<b>Telescopic Guide rails, total Extraction</b>	1
<b>40mm deep tray</b>	1		

## Electrical Connection

<b>Max Power Draw</b>	10900 W	<b>Cable testing</b>	Yes
<b>Current</b>	32 A	<b>Additional connection modalities</b>	Yes, Double and Three Phase
<b>Voltage</b>	220-240 V	<b>Frequency</b>	50/60 Hz
<b>Voltage 2 (V)</b>	380-415 V	<b>Terminal block</b>	5 poles
<b>Type of electric cable</b>	Yes, Single phase	<b>Plug</b>	No



## Compatible Accessories

### AIRFRY

Air fryer rack AIRFRY. Ideal for recreating traditional frying in the oven, but with fewer calories and less fat. It allows you to cook quickly and simply dishes such as French fries, fried vegetables and fish, ensuring perfect browning and crispiness.



### BBQ

Double sided plate BBQ. Suitable for recreating succulent and crispy dishes in the oven with the typical taste of grilled cooking. The ribbed side is particularly suitable for meats and cheeses. The smooth side for fish, seafood and vegetables.



### BN640

Enamelled tray, 40mm deep



### GRILLPLATE

Universal griddle for induction, gas, ceramic and electric hobs. Non-stick surface ideal for cooking meat, cheese and vegetables. Dimensions: 410 x 240 mm.



### GTT

\*\*Totally extractable telescopic guides (1 level)\*\* Extraction: 433 mm Material: Stainless steel AISI 430 polished



### KITH95CPF120

Height extension kit (950 mm), suitable for TR4110 cookers



### PALPZ

Pizza shovel with fold away handle width: 315mm length : 325mm



### SFLK1

Child lock



### AIRFRY2

Air fryer tray. Ideal for recreating traditional frying in the oven, but with fewer calories and less fat. It allows you to cook quickly and simply dishes such as French fries, fried vegetables and fish, ensuring perfect browning and crispiness.



### BN620-1

Enamelled tray, 20mm deep



### BNP608T

Teflon-coated tray, 8mm depth, to be placed on the grid



### GTP

\*\*Partially extractable telescopic guides (1 level)\*\* Extraction: 300 mm Material: Stainless steel AISI 430 polished



### KIT1CPF120X

Splashback 120x60 cm, stainless steel, suitable for Portofino cookers



### KITP65CPF120

Depth extension kit (650 mm), suitable for TR4110 cookers



### SCRP

Induction and ceramic hobs and teppanyaki scraper



### SMOLD

Set of 7 silicone moulds for ice creams, ice lollies, pralines, ice cubes or to portion food. Usable from -60°C to +230°C

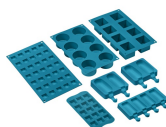



#### TPKPLATE

Universal plate for induction, gas, ceramic and electric hobs. Non-stick surface ideal for cooking fish, eggs and vegetables. Dimensions: 410 X 240 mm.



#### WOKGHU

Cast-Iron WOK Support

---

## Alternative products

---



**CPF120IGMPX**  
Colour: Stainless steel



**CPF120IGMPR**  
Colour: Red







































**CPF120IGMPBL**  
Colour: Black



**CPF120IGMPT**  
Colour: Turquoise

## Symbols glossary

 <p>Automatic merge of zones for a bigger area</p>	 <p>Heavy duty cast iron pan stands: for maximum stability and strength.</p>
 <p>A: Product drying performance, measured from A+++ to D / G depending on the product family</p>	 <p>A+: Energy efficiency class A+ helps to save up to 10% energy compared to class A. Maximum performance with minimum consumption is guaranteed.</p>
 <p>Installation in column: Installation in column</p>	 <p>Knobs control</p>
 <p>Air cooling system: to ensure a safe surface temperatures.</p>	 <p>A DIRECT STEAM oven has 1 steam cooking function to which the user can MANUALLY add steam. The function is activated when the user turns the function knob to the STEAM ON position, and deactivated when the user turns the steam knob to the STEAM OFF position. The user decides at the start of the cooking process how much water to load, up to 250ml. The water in the cavity then becomes steam during the cooking process.</p>
 <p>The touch timer display or DigiScreen guarantees simple functionality. They display the time, set programmed cooking and the minute minder timer.</p>	 <p>Triple glazed doors: Number of glazed doors.</p>
 <p>Quadruple glazed: Number of glazed doors.</p>	 <p>ECO-logic: option allows you to restrict the power limit of the appliance real energy saving.</p>
 <p>Enamel interior: The enamel interior of all Smeg ovens have a special antacid lining which helps keep the interior clean by reducing the amount of cooking grease adhering to it.</p>	 <p>Fan assisted base: the mix of fan and lower heating element alone allows to finish cooking foods already cooked on the surface but not internally more quickly. This system is recommended to finish cooking foods that are already well cooked on the surface, but not internally, which therefore require a moderate higher heat. Ideal for any type of food.</p>
 <p>Fan with upper and lower elements: The elements combined with the fan aim to provide more uniform heat, a similar method to conventional cooking, so pre-heat is required. Most suitable for items requiring slow cooking methods.</p>	 <p>Upper and lower element only: a traditional cooking method best suited for single items located in the centre of the oven. the top of the oven will always be hottest. Ideal for roast, fruit cakes, bread etc.</p>
 <p>Circulaire: The combination of the fan and circular element around it gives a hot air cooking method. This provides many benefits including no preheat if cook time is more than 20 minutes, no flavour transfer when cooking different foods at the same time, less energy, and shorter cook times. Good for all types of food.</p>	 <p>ECO: The combination of the grill, fan and lower element is particularly suitable for cooking small quantities of food.</p>

- |   |  |
|---|--|
|  <p><b>Grill element:</b> Using of grill gives excellent results when cooking meat of medium and small portions, especially when combined with a rotisserie (where possible). Also ideal for cooking sausages and bacon.</p>  |  <p><b>Half grill:</b> For rapid cooking and browning of foods. Best results can be obtained by using the top shelf for small items, the lower shelves for larger ones, such as chops or sausages. For half grill heat is generated only at the centre of the element, so is ideal for smaller quantities.</p>  |
|  <p><b>Fan with grill element:</b> The fan reduces the fierce heat from the grill, providing an excellent method of grilling various foods, chops, steaks, sausages etc. giving even browning and heat distribution, without drying out the food. The top two levels recommended for use, and the lower part of the oven can be used to keep items warm at the same time, an excellent facility when cooking a grilled breakfast. Half grill (centre portion only) is ideal for small quantities of food.</p> |  <p><b>Circulaire with upper and lower elements:</b> The use of the fan with both elements allows food to be cooked quickly and effectively, ideal for large joints that require thorough cooking. It offers a similar result to rotisserie, moving the heat around the food, instead of moving the food itself, enabling any size or shape to be cooked.</p> |
|  <p><b>Circulaire with steam assist:</b> Provides extra moisture to food during cooking. Excellent for bread baking. The moisture allows the bread dough to stretch further at the beginning of cooking, creating an aerated and light textured dough. The remaining part of the cooking process allows for the signature crust to form.</p>  |  <p><b>Overheat protection:</b> The safety system that automatically turns off the hob in case of overheating of the control unit.</p>  |
|  <p><b>All glass inner door:</b> All glass inner door, a single flat surface which is simple to keep clean.</p>   |  <p><b>The inner door glass:</b> can be removed with a few quick movements for cleaning.</p>  |
|  <p><b>Side lights:</b> Two opposing side lights increase visibility inside the oven.</p>   |  <p><b>Automatic opening:</b> some models have Automatic opening door when the cycle is finished which is a perfect solution for handle-less kitchen units as no handle is needed. For safety reasons, the door locks automatically when the machine is in use to avoid it being opened inadvertently.</p>  |
|  <p><b>Pyrolytic:</b> Pyrolytic cleaning cycles can be selected as necessary to automatically clean the oven interior.</p>  |  <p><b>Indication of residual heat:</b> After the glass ceramic hob is switched off the residual heat indicator shows which of the heating zones still remains hot. When the temperature drops below 60 ° C, the indicator goes out.</p>  |
|  <p><b>5</b> The oven cavity has 5 different cooking levels.</p>  |  <p><b>Soft close:</b> all models are equipped with advanced function of smooth closing of the door, which allows the device to close smoothly and quietly.</p>   |
|  <p><b>Telescopic rails:</b> allow you to pull out the dish and check it without having to remove it from the oven entirely.</p>  |  <p><b>Electronic control:</b> Allows you to maintain temperature inside the oven with the precision 2-3 ° C. This enables to cook meals that are very sensitive to temperature changes, such as cakes, souffles, puddings.</p>   |
|  <p><b>Tilting grill:</b> the tilting grill can be easily unhooked to move the heating element and clean the roof of the appliance in one simple step.</p>  |  <p><b>UR</b> Ultra rapid burners: Powerful ultra rapid burners offer up to 5kw of power.</p>   |



Vapor Clean: a simple cleaning function using steam to loosen deposits in the oven cavity.



The capacity indicates the amount of usable space in the oven cavity in litres.



The capacity indicates the amount of usable space in the oven cavity in litres.

## Benefit

---

### **Pyrolysis**

Easy oven cleaning thanks to special pyrolytic function

### **Touch control**

Easy and intuitive timer setting with a single touch

### **Drawer storage compartment**

More space thanks to the lower compartment, ideal for storing accessories or cooking utensils

### **Circulaire**

The best cooking performances guaranteed by ventilated circular flow.

Multiple fans and heating elements guarantee the perfect aerodynamic heat flow, allowing homogeneous and quicker cooking inside the cavity.

### **Multilevel cooking**

Several cooking levels allow maximum flexibility of use

### **Multilevel halogen light**

Internal halogen lighting on different levels guarantees excellent visibility

### **Removable inner glass**

Internal door glasses are easily removable for complete cleaning

### **Tangential cooling**

New cooling system with tangential fan and airflow from the door to the splashback

### **Telescopic guides**

Easy extraction and safe insertion of trays into the oven thanks to telescopic guides

### **Adjustable height**

Cooker top flushed with the working area thanks to adjustable feet

### **AirFry (AIRFRY optional accessory)**

Lighter and tastier food thanks to airfry basket

### **Cold door**

During any function, the external door glass is cold, avoiding any risk of burns

### **Pizza stone (optional accessory)**

Baking with refractory stone for soft and crispy pizza and yeast products (STONE optional accessory)

**BBQ (optional accessory)**

Barbeque cooking directly in the oven with the double-sided grill

**Isothermic Cavity**

The best cooking performance at the highest energy efficiency

**Soft close**

The door is equipped with a specific system for silent closing

**Single turbine**

The oven has a fan equipped with a circular heating element allowing cooking with rotating heat

**Direct Steam**

Steam is generated from water placed in a dedicated basin at the bottom of the cavity