

CPF30UGGAN

Cooker size	30"
N. of cavities with energy label	1
Cavity heat source	GAS
Type of main oven	Gas with gas grill
EAN code	8017709270292



Aesthetics



Design	Flush fit	Controls colour	Stainless steel
Command panel finish	Enamelled metal	No. of controls	7
Aesthetic	Portofino	Serigraphy colour	Silver
Logo	Assembled st/steel	Display	Touch
Colour	Anthracite	Door	With frame
Logo position	Facia below the oven	Glass type	Grey
Upstand	Yes	Handle	Smeg Portofino
Hob colour	Stainless steel	Handle Colour	coloured
Type of pan stands	Cast Iron	Storage compartment	Door
Type of control setting	Control knobs	Feet	Stainless steel
Control knobs	Smeg Portofino	Plinth	Black

Programs / Functions

No. of cooking functions	2
--------------------------	---

Hob technical features



Total no. of cook zones	4
Left - Gas - 2UR (dual) - 5.86 kW - 20000 BTU	
Front centre - Gas - Semi Rapid - 2.34 kW - 8000 BTU	
Rear centre - Gas - AUX - 1.31 kW - 4500 BTU	
Right - Gas - UR - 5.86 kW - 20000 BTU	

Type of gas burners	Standard	Gas safety valves	Yes
Automatic electronic ignition	Yes	Burner caps	Matt black enamelled

Main Oven Technical Features



No. of lights	2	Removable door	Yes
Fan number	1	Full glass inner door	Yes
Gross volume, 1st cavity	0.13 cu. ft.	Removable inner door	Yes
Cavity material	Ever Clean enamel	Total no. of door glasses	3
No. of shelves	4	No. of thermo-reflective door glasses	2
Type of shelves	Metal racks	Safety Thermostat	Yes
Light type	Halogen	Cooling system	Tangential
Light Power	40 W	Usable cavity space dimensions (HxWxD)	317 x 640 x 430 "
Cooking time setting	Start and Stop	Temperature control	Electro-mechanical
Light when oven door is open	Yes	Grill type	Gas
Door opening	Flap down	Soft Close system	Yes

Options Main Oven

Timer	Yes	Minimum Temperature	120 °F
End of cooking acoustic alarm	Yes	Maximum temperature	500 °F

Accessories included for Main Oven & Hob



Cast iron wok support	1	40mm deep tray	1
Oven grid with stop, tray support	1	Grill mesh	1
TOP Oven grid with back stop	2	Telescopic Guide rails, partial Extraction	1

Electrical Connection

Electrical connection rating	200 W	Power supply cable length	55 1/8 "
Current	2 A	Frequency	60 Hz
Circuit breaker	15 A	Terminal block	3 poles
Voltage	120 V	Plug	(B) NEMA 5-15P
Type of electric cable installed	Yes, Single phase		

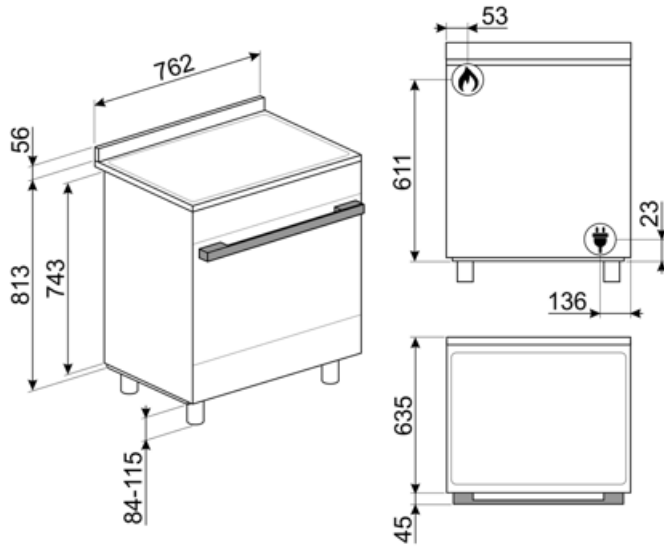

Compatible Accessories



GT91P

Partially extractable telescopic guides suitable for CPF30 cookers, USA



SFLK1

Child lock



PALPZ

Pizza shovel with folding handle. Dimensions L31.5 x H32.5 cm. Easy and convenient to use and store. Perfect for serving pizza, bread and savory pastries in a safe and professional way.

Alternative products



CPF30UGGX

Colour: Stainless steel



CPF30UGGR

















Colour: Red



CPF30UGGWH

Colour: White

Symbols glossary

 <p>Heavy duty cast iron pan stands: for maximum stability and strength.</p>	 <p>Installation in column: Installation in column</p>
 <p>Air cooling system: to ensure a safe surface temperatures.</p>	 <p>Triple glazed doors: Number of glazed doors.</p>
 <p>Ever Clean Enamel: Ever Clean enamel is applied electrostatically, corner to corner and edge to edge to prevent cracking or cracks over time. It is a particular pyrolytic enamel, resistant to acids which, in addition to being pleasantly bright, promotes greater cleaning of the oven walls, thanks to its lower porosity. It is baked at over 850 ° C and slowly polymerized at a scientifically determined rate to ensure uniform depth and strength Ever Clean enamel creates an impeccable finish both on the inside of the oven and on the trays, making the surfaces of the oven incredibly easy to maintain over time as it reduces the adhesion of fat during cooking</p>	 <p>Gas ovens offer instantaneous heat control, reduced cooking times and the ability to bake at much lower temperatures than electric ovens.</p>
 <p>All glass inner door: All glass inner door, a single flat surface which is simple to keep clean.</p>	 <p>The inner door glass: can be removed with a few quick movements for cleaning.</p>
 <p>Side lights: Two opposing side lights increase visibility inside the oven.</p>	 <p>Automatic opening: some models have Automatic opening door when the cycle is finished which is a perfect solution for handle-less kitchen units as no handle is needed. For safety reasons, the door locks automatically when the machine is in use to avoid it being opened inadvertently.</p>
 <p>The oven cavity has 4 different cooking levels.</p>	 <p>Soft close: all models are equipped with advanced function of smooth closing of the door, which allows the device to close smoothly and quietly.</p>
 <p>Telescopic rails: allow you to pull out the dish and check it without having to remove it from the oven entirely.</p>	 <p>Ultra rapid burners: Powerful ultra rapid burners offer up to 5kw of power.</p>
 <p>4.3 inch display with LED technology, usability with knobs + 3 touch keys</p>	 <p>Knobs control</p>