

# CPF30UGGBL

Range size	30"
N. of cavities with energy label	1
Oven energy source	Gas
Main oven	Gas with grill
EAN code	8017709270285



## Aesthetic



<b>Aesthetics</b>	Portofino	<b>Controls color</b>	Stainless steel
<b>Design</b>	Flush mounted	<b>No. of controls</b>	7
<b>Color</b>	Black	<b>Silkscreen color</b>	Silver
<b>Control panel finish</b>	Metal enameled	<b>Display</b>	Touch
<b>Logo</b>	Stainless steel	<b>Door</b>	With frame
<b>Logo position</b>	Fascia below the oven	<b>Door glass type</b>	Gray
<b>Upstand</b>	Yes	<b>Handle</b>	Portofino
<b>Cooktop color</b>	Stainless steel	<b>Handle color</b>	Colored
<b>Grates</b>	Cast Iron	<b>Storage compartment</b>	Storage drawer
<b>Control setting type</b>	Control knobs	<b>Feet</b>	Stainless steel
<b>Control knobs</b>	Portofino	<b>Plinth</b>	Black

## Programs / Functions

No. of cooking functions 3

Traditional cooking functions



Large grill



Bottom



Convection bottom

Other functions



Defrost by time

## Cooktop technical features

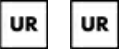

### Cooking zones 4

Left - Gas - Dual ultra-rapid - 5860 W - 20000 BTU  
 Front-center - Gas - Semi-rapid - 2340 W - 8000 BTU  
 Rear-center - AUX - 1310 W - 4500 BTU  
 Right - Gas - Ultra-rapid - 5860 W - 20000 BTU

<b>Burners type</b>	Standard	<b>Gas safety valves</b>	Yes
<b>Automatic gas ignition</b>	Yes	<b>Burner caps</b>	Enameled matte black

## Main Oven Technical Features



<b>No. of lights</b>	2	<b>Removable door</b>	Yes
<b>Fan number</b>	1	<b>Full-glass inner door</b>	Yes
<b>Volume</b>	0.13 cu. ft.	<b>Removable inner door</b>	Yes
<b>Cavity material</b>	EverClean enamel	<b>Total no. of door glasses</b>	3
<b>No. of shelves</b>	4	<b>No. of thermo-reflective door glasses</b>	2
<b>Shelves type</b>	Metal racks	<b>Safety thermostat</b>	Yes
<b>Light type</b>	Halogen	<b>Cooling system</b>	Tangential
<b>Light Power</b>	40 W	<b>Inner cavity dimensions (HxWxD)</b>	317 x 640 x 430 "
<b>Time setting</b>	Start and end	<b>Temperature control</b>	Electro-mechanical
<b>Light on when door is open</b>	Yes	<b>Grill type</b>	Gas
<b>Door opening</b>	Drop-down	<b>Soft Close system</b>	Yes

## Main oven options

<b>Timer</b>	Yes	<b>Minimum Temperature</b>	120 °F
<b>End-of-cooking alarm</b>	Yes	<b>Maximum temperature</b>	500 °F

## Accessories included for main oven and cooktop



<b>Cast iron wok support</b>	1	<b>1.6"-deep tray</b>	1
<b>Oven wire rack</b>	1	<b>Grill mesh</b>	1
<b>TOP Oven grid with back stop</b>	2	<b>Telescopic Guide rails, partial Extraction</b>	1

## Electrical Connection

<b>Plug</b>	(B) NEMA 5-15P	<b>Power cord length</b>	47 1/4 "
<b>Electrical connection rating</b>	200 W	<b>Frequency</b>	60 Hz
<b>Current</b>	2 A	<b>Terminal block</b>	3 pins
<b>Voltage</b>	120 V		

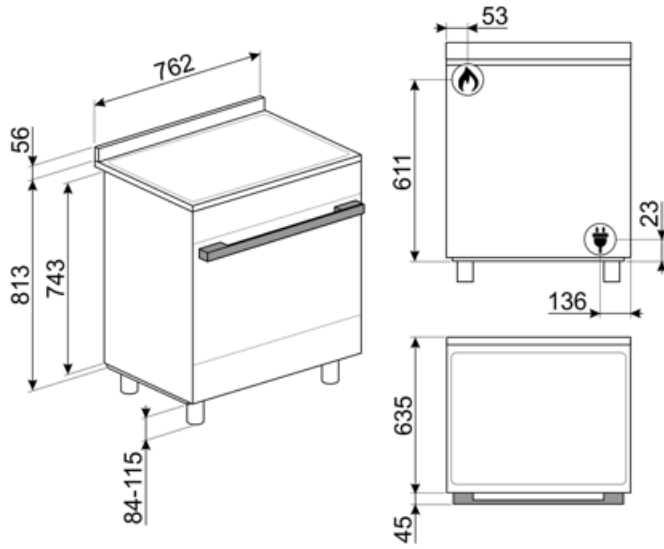

---

## Not included accessories

---



### GT91P

Partial-extraction telescopic guides for 30" Portofino ranges



### SFLK1

Child lock



### PRTX





















Refractory pizza stone with handles. D=35cm Not suitable for microwave ovens. Suitable for gas ovens, to be put on the griddle.



### PALPZ

Pizza shovel with fold away handle  
width: 315mm length : 325mm

## Symbols glossary (TT)

	Heavy duty cast iron pan stands: for maximum stability and strength.		Installation in column: Installation in column
	Air cooling system: to ensure a safe surface temperatures.		Defrost by time: with this function the time of thawing of foods are determined automatically.
	Triple glazed doors: Number of glazed doors.		Enamel interior: The enamel interior of all Smeg ovens have a special antacid lining which helps keep the interior clean by reducing the amount of cooking grease adhering to it.
	Circogas: In gas ovens the fan distributes the heat quickly and evenly throughout the oven cavity, avoiding flavour transfer when cooking a number of different dishes at the same time. In electric ovens this combination completes cooking more quickly of foods that are ready on the surface, but that require more cooking inside, without further browning.		Lower heating element only: This function is ideal for foods that require extra base temperature without browning, e.g. pastry dishes, pizza. Also suitable for slow cooking of stews and casseroles.
	Grill element: Using of grill gives excellent results when cooking meat of medium and small portions, especially when combined with a rotisserie (where possible). Also ideal for cooking sausages and bacon.		Gas ovens offer instantaneous heat control, reduced cooking times and the ability to bake at much lower temperatures than electric ovens.
	All glass inner door: All glass inner door, a single flat surface which is simple to keep clean.		The inner door glass: can be removed with a few quick movements for cleaning.
	Side lights: Two opposing side lights increase visibility inside the oven.		Automatic opening: some models have Automatic opening door when the cycle is finished which is a perfect solution for handle-less kitchen units as no handle is needed. For safety reasons, the door locks automatically when the machine is in use to avoid it being opened inadvertently.
	The oven cavity has 4 different cooking levels.		Soft close: all models are equipped with advanced function of smooth closing of the door, which allows the device to close smoothly and quietly.
	Telescopic rails: allow you to pull out the dish and check it without having to remove it from the oven entirely.		Ultra rapid burners: Powerful ultra rapid burners offer up to 5kw of power.
	...		Knobs control

## Benefit (TT)

---

### **Gas hob**

Induction offers fast cooking and precise temperature control

Equipped with a thermocouple, the gas supply is cut off if the flame is extinguished for greater safety

### **Touch control**

Easy and intuitive timer setting with a single touch

### **Single turbine**

The oven has a fan equipped with a circular heating element allowing cooking with rotating heat

### **Isothermic Cavity**

The best cooking performance at the highest energy efficiency

### **Tangential cooling**

New cooling system with tangential fan and airflow from the door to the splashback

### **Soft close**

The door is equipped with a specific system for silent closing

### **Multilevel halogen light**

Internal halogen lighting on different levels guarantees excellent visibility

### **Telescopic guides**

Easy extraction and safe insertion of trays into the oven thanks to telescopic guides

### **Adjustable height**

Cooker top flushed with the working area thanks to adjustable feet

### **Removable inner glass**

Internal door glasses are easily removable for complete cleaning

### **Multilevel cooking**

Several cooking levels allow maximum flexibility of use

### **Cold door**

During any function, the external door glass is cold, avoiding any risk of burns

### **AirFry (AIRFRY optional accessory)**

Lighter and tastier food thanks to airfry basket

**BBQ (optional accessory)**

Barbeque cooking directly in the oven with the double-sided grill

**Pizza stone (optional accessory)**

Baking with refractory stone for soft and crispy pizza and yeast products (STONE optional accessory)

**Storage compartment**

More space thanks to the lower compartment, ideal for storing accessories or cooking utensils