

# CPF36UGGWH

Range size	36"
N. of cavities with energy label	1
Oven energy source	Gas
Main oven	Gas with grill
EAN code	8017709265236



## Aesthetic



<b>Aesthetics</b>	Portofino	<b>Controls color</b>	Stainless steel
<b>Design</b>	Flush mounted	<b>No. of controls</b>	8
<b>Color</b>	White	<b>Silkscreen color</b>	Black
<b>Control panel finish</b>	Metal enameled	<b>Display</b>	Touch
<b>Logo</b>	Stainless steel	<b>Door</b>	With frame
<b>Logo position</b>	Fascia below the oven	<b>Door glass type</b>	Gray
<b>Upstand</b>	Yes	<b>Handle</b>	Portofino
<b>Cooktop color</b>	Stainless steel	<b>Handle color</b>	Colored
<b>Grates</b>	Cast Iron	<b>Storage compartment</b>	Push-pull
<b>Control setting type</b>	Control knobs	<b>Feet</b>	Stainless steel
<b>Control knobs</b>	Portofino	<b>Plinth</b>	Black

## Programs / Functions

No. of cooking functions 3

Traditional cooking functions



Large grill

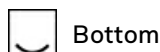

Bottom

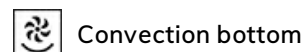

Convection bottom

Other functions



Defrost by time

## Cooktop technical features

UR

**Cooking zones 5**

Left - Gas - Dual ultra-rapid - 5860 W - 20000 BTU  
 Rear-center - Gas - AUX - 1310 W - 4500 BTU  
 Front-center - Gas - Rapid - 3080 W - 10500 BTU  
 Rear-right - Gas - Rapid - 3510 W - 12000 BTU  
 Front-right - Gas - Semi-rapid - 2340 W - 8000 BTU

<b>Burners type</b>	Standard	<b>Gas safety valves</b>	Yes
<b>Automatic gas ignition</b>	Yes	<b>Burner caps</b>	Enameled matte black

**Main Oven Technical Features**



<b>No. of lights</b>	2	<b>Full-glass inner door</b>	Yes
<b>Fan number</b>	3	<b>Removable inner door</b>	Yes
<b>Volume</b>	0.16 cu. ft.	<b>Total no. of door glasses</b>	3
<b>Cavity material</b>	EverClean enamel	<b>No. of thermo-reflective door glasses</b>	2
<b>No. of shelves</b>	5	<b>Safety thermostat</b>	Yes
<b>Shelves type</b>	Metal racks	<b>Cooling system</b>	Tangential
<b>Light type</b>	Halogen	<b>Inner cavity dimensions (HxWxD)</b>	345 x 690 x 415 "
<b>Light Power</b>	40 W	<b>Temperature control</b>	Electro-mechanical
<b>Time setting</b>	Start and end	<b>Grill type</b>	Gas
<b>Door opening</b>	Drop-down	<b>Soft Close system</b>	Yes
<b>Removable door</b>	Yes		

**Main oven options**

<b>Timer</b>	Yes	<b>Minimum Temperature</b>	120 °F
<b>End-of-cooking alarm</b>	Yes	<b>Maximum temperature</b>	500 °F

**Accessories included for main oven and cooktop**



<b>Cast iron wok support</b>	1	<b>Grill mesh</b>	1
<b>TOP Oven grid with back stop</b>	2	<b>Telescopic Guide rails, total Extraction</b>	1
<b>0.8"-deep tray</b>	1		

**Electrical Connection**

<b>Plug</b>	(B) NEMA 5-15P	<b>Voltage (V)</b>	120 V
<b>Electrical connection rating</b>	200 W	<b>Type of electric cable installed</b>	Yes, Single phase
<b>Current</b>	2 A	<b>Power cord length</b>	47 1/4 "
<b>Circuit breaker</b>	15 A	<b>Frequency</b>	60 Hz
<b>Voltage</b>	120 V	<b>Terminal block</b>	3 pins

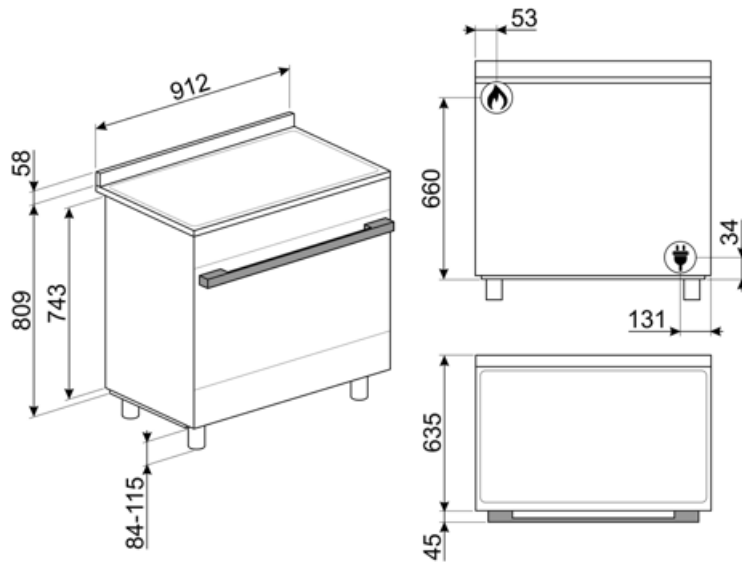

---

## Not included accessories

---



**SFLK1**  
Child lock



**BGTR9**  
Cast iron grill plate suitable for 90 cm Victoria, 60 and 90 cm Master and Sinfonia cookers



**PPR9**  
Refractory pizza stone without handles. Squared stone (HxWxD): 0.9" x 25.2" x 14.75". Also suitable for gas ovens, to be placed on a rack



**PRTX**  
Refractory pizza stone with handles. D=35cm Not suitable for microwave ovens. Suitable for gas ovens, to be put on the griddle.























**GT3T**



**PALPZ**  
Pizza shovel with fold away handle width: 315mm length : 325mm

## Symbols glossary (TT)

 <p><b>Triple Fan Technology:</b> The oven is equipped with an exclusive three fan system, which, combined with the increased power of the motors, enables excellent cooking performance. The two large side fans distribute the air around the outer perimeter of the cavity while the smaller central fan increases ventilation by creating a vertical vortex of heat. Accordingly, the temperature within the cavity is uniform, allowing food to be cooked evenly on all five levels, like in professional kitchens.</p>	 <p><b>Heavy duty cast iron pan stands:</b> for maximum stability and strength.</p>
 <p><b>Installation in column:</b> Installation in column</p>	 <p><b>Air cooling system:</b> to ensure a safe surface temperatures.</p>
 <p><b>Defrost by time:</b> with this function the time of thawing of foods are determined automatically.</p>	 <p><b>Triple glazed doors:</b> Number of glazed doors.</p>
 <p><b>Enamel interior:</b> The enamel interior of all Smeg ovens have a special antacid lining which helps keep the interior clean by reducing the amount of cooking grease adhering to it.</p>	 <p><b>Circogas:</b> In gas ovens the fan distributes the heat quickly and evenly throughout the oven cavity, avoiding flavour transfer when cooking a number of different dishes at the same time. In electric ovens this combination completes cooking more quickly of foods that are ready on the surface, but that require more cooking inside, without further browning.</p>
 <p><b>Lower heating element only:</b> This function is ideal for foods that require extra base temperature without browning, e.g. pastry dishes, pizza. Also suitable for slow cooking of stews and casseroles.</p>	 <p><b>Grill element:</b> Using of grill gives excellent results when cooking meat of medium and small portions, especially when combined with a rotisserie (where possible). Also ideal for cooking sausages and bacon.</p>
 <p><b>Gas ovens offer instantaneous heat control,</b> reduced cooking times and the ability to bake at much lower temperatures than electric ovens.</p>	 <p><b>All glass inner door:</b> All glass inner door, a single flat surface which is simple to keep clean.</p>
 <p><b>The inner door glass:</b> can be removed with a few quick movements for cleaning.</p>	 <p><b>Side lights:</b> Two opposing side lights increase visibility inside the oven.</p>
 <p><b>Automatic opening:</b> some models have Automatic opening door when the cycle is finished which is a perfect solution for handle-less kitchen units as no handle is needed. For safety reasons, the door locks automatically when the machine is in use to avoid it being opened inadvertently.</p>	 <p><b>The oven cavity has 5 different cooking levels.</b></p>
 <p><b>Soft close:</b> all models are equipped with advanced function of smooth closing of the door, which allows the device to close smoothly and quietly.</p>	 <p><b>Telescopic rails:</b> allow you to pull out the dish and check it without having to remove it from the oven entirely.</p>
 <p><b>Ultra rapid burners:</b> Powerful ultra rapid burners offer up to 5kw of power.</p>	 <p>...</p>



Knobs control

---

## Benefit (TT)

---

### **Gas hob**

Induction offers fast cooking and precise temperature control

Equipped with a thermocouple, the gas supply is cut off if the flame is extinguished for greater safety

### **Touch control**

Easy and intuitive timer setting with a single touch

### **Isothermic Cavity**

The best cooking performance at the highest energy efficiency

### **Triple Turbine**

The oven has three fans and two circular heating elements, allowing cooking with rotating heat

### **Tangential cooling**

New cooling system with tangential fan and airflow from the door to the splashback

### **Soft close**

The door is equipped with a specific system for silent closing

### **Multilevel halogen light**

Internal halogen lighting on different levels guarantees excellent visibility

### **Telescopic guides**

Easy extraction and safe insertion of trays into the oven thanks to telescopic guides

### **Adjustable height**

Cooker top flushed with the working area thanks to adjustable feet

### **Removable inner glass**

Internal door glasses are easily removable for complete cleaning

### **Multilevel cooking**

Several cooking levels allow maximum flexibility of use

### **Cold door**

During any function, the external door glass is cold, avoiding any risk of burns

### **AirFry (AIRFRY optional accessory)**

Lighter and tastier food thanks to airfry basket

**BBQ (optional accessory)**

Barbeque cooking directly in the oven with the double-sided grill

**Pizza stone (optional accessory)**

Baking with refractory stone for soft and crispy pizza and yeast products (STONE optional accessory)

**Push-pull storage compartment**

More space thanks to the lower push-pull compartment, ideal for storing accessories or cooking utensils