

CPF36UGMBL

Range size	36"
N. of cavities with energy label	1
Oven energy source	Electricity
Main oven	Thermo-ventilated
Cleaning system - Main oven	VaporClean
EAN code	8017709254001



Aesthetic



Aesthetics	Portofino	Controls color	Stainless steel
Design	Flush mounted	No. of controls	8
Color	Black	Silkscreen color	Silver
Control panel finish	Metal enameled	Display	Touch
Logo	Stainless steel	Door	With frame
Logo position	Fascia below the oven	Door glass type	Gray
Upstand	Yes	Handle	Portofino
Cooktop color	Stainless steel	Handle color	Colored
Grates	Cast Iron	Storage compartment	Push-pull
Control setting type	Control knobs	Feet	Stainless steel
Control knobs	Portofino	Plinth	Black

Programs / Functions

No. of cooking functions	10
--------------------------	----

Traditional cooking functions

Static	Fan-assisted	True European convection
Small grill	Large grill	Large grill + Fan
Bottom	Convection bottom	Pizza
Rotisserie		

Other functions

Defrost by time

Cleaning functions

VaporClean

Cooktop technical features

UR			
Cooking zones 5			
Left - Gas - Dual ultra-rapid - 5860 W - 20000 BTU			
Rear-center - Gas - AUX - 1310 W - 4500 BTU			
Front-center - Gas - Rapid - 3080 W - 10500 BTU			
Rear-right - Gas - Rapid - 3510 W - 12000 BTU			
Front-right - Gas - Semi-rapid - 2340 W - 8000 BTU			
Burners type Standard	Gas safety valves Yes		
Automatic gas ignition Yes	Burner caps Enameled matte black		

Main Oven Technical Features

No. of lights 2	Fan number 3	Volume 0.16 cu. ft.	Cavity material EverClean enamel	No. of shelves 5	Shelves type Metal racks	Light type Halogen	Light Power 40 W	Time setting Start and end	Light on when door is open Yes	Door opening Drop-down	Removable door Yes	Total no. of door glasses 3	No. of thermo-reflective door glasses 2	Safety thermostat Yes	Cooling system Tangential	Inner cavity dimensions (HxWxD) 370 x 690 x 415 "	Temperature control Electro-mechanical	Bottom heating element - Power 1700 W	Upper heating element - Power 1200 W	Grill power 1700 W	Large grill - Power 2900 W

Full-glass inner door	Yes	Circular heating element	2 x 1550 W
Removable inner door	Yes	- Power	
		Grill type	Electric
		Tilting grill	Yes
		Soft Close system	Yes

Main oven options

Timer	Yes	Minimum Temperature	120 °F
End-of-cooking alarm	Yes	Maximum temperature	500 °F

Accessories included for main oven and cooktop



Cast iron wok support	1	1.6"-deep tray	1
TOP Oven grid with back stop	2	Telescopic Guide rails, total Extraction	1

Electrical Connection

Electrical connection rating	3800 W	Power cord length	47 1/4 "
Current	20 A	Frequency	60 Hz
Voltage	240/208 V	Terminal block	5 poles

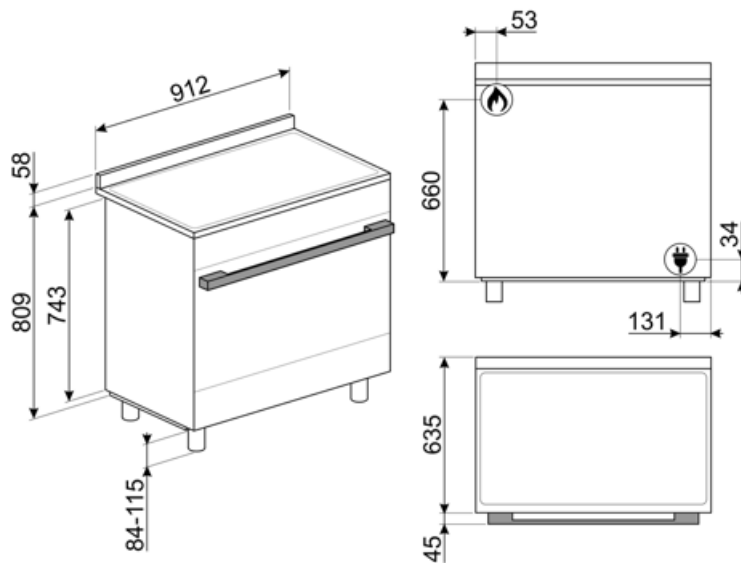

Not included accessories



SFLK1
Child lock



BGTR9
Cast iron grill plate suitable for 90 cm Victoria, 60 and 90 cm Master and Sinfonia cookers



PPR9
Refractory pizza stone without handles. Squared stone (HxWxD): 0.9" x 25.2" x 14.75". Also suitable for gas ovens, to be placed on a rack



PRTX
Refractory pizza stone with handles. D=35cm Not suitable for microwave ovens. Suitable for gas ovens, to be put on the griddle.

















GT3T















PALPZ

Pizza shovel with fold away handle width: 315mm length : 325mm



Symbols glossary (TT)

 <p>Triple Fan Technology: The oven is equipped with an exclusive three fan system, which, combined with the increased power of the motors, enables excellent cooking performance. The two large side fans distribute the air around the outer perimeter of the cavity while the smaller central fan increases ventilation by creating a vertical vortex of heat. Accordingly, the temperature within the cavity is uniform, allowing food to be cooked evenly on all five levels, like in professional kitchens.</p>	 <p>Heavy duty cast iron pan stands: for maximum stability and strength.</p>
 <p>Installation in column: Installation in column</p>	 <p>Air cooling system: to ensure a safe surface temperatures.</p>
 <p>Defrost by time: with this function the time of thawing of foods are determined automatically.</p>	 <p>Triple glazed doors: Number of glazed doors.</p>
 <p>Enamel interior: The enamel interior of all Smeg ovens have a special antacid lining which helps keep the interior clean by reducing the amount of cooking grease adhering to it.</p>	 <p>Circogas: In gas ovens the fan distributes the heat quickly and evenly throughout the oven cavity, avoiding flavour transfer when cooking a number of different dishes at the same time. In electric ovens this combination completes cooking more quickly of foods that are ready on the surface, but that require more cooking inside, without further browning.</p>
 <p>Fan with upper and lower elements: The elements combined with the fan aim to provide more uniform heat, a similar method to conventional cooking, so pre-heat is required. Most suitable for items requiring slow cooking methods.</p>	 <p>Upper and lower element only: a traditional cooking method best suited for single items located in the centre of the oven. the top pf the oven will always be hottest. Ideal for roast, fruit cakes, bread etc.</p>
 <p>Lower heating element only: This function is ideal for foods that require extra base temperature without browning, e.g. pastry dishes, pizza. Also suitable for slow cooking of stews and casseroles.</p>	 <p>True European Convection: The combination of the fan and circular heating element around it provides many benefits, including no preheat if cooking time is longer than 20 minutes, no flavor transfer when cooking different foods at the same time, lower energy consumption, and shorter cooking times. Suitable for all types of food preparations.</p>
 <p>Grill element: Using of grill gives excellent results when cooking meat of medium and small portions, especially when combined with a rotisserie (where possible). Also ideal for cooking sausages and bacon.</p>	 <p>Half grill: For rapid cooking and browning of foods. Best results can be obtained by using the top shelf for small items, the lower shelves for larger ones, such as chops or sausages. For half grill heat is generated only at the centre of the element, so is ideal for smaller quantities.</p>

-  Fan with grill element: The fan reduces the fierce heat from the grill, providing an excellent method of grilling various foods, chops, steaks, sausages etc. giving even browning and heat distribution, without drying out the food. The top two levels recommended for use, and the lower part of the oven can be used to keep items warm at the same time, an excellent facility when cooking a grilled breakfast. Half grill (centre portion only) is ideal for small quantities of food.
-  Rotisserie: The rotisserie (where installed) works in combination with the grill element to brown foods to perfection.
-  The inner door glass: can be removed with a few quick movements for cleaning.
-  Automatic opening: some models have Automatic opening door when the cycle is finished which is a perfect solution for handle-less kitchen units as no handle is needed. For safety reasons, the door locks automatically when the machine is in use to avoid it being opened inadvertently.
-  Soft close: all models are equipped with advanced function of smooth closing of the door, which allows the device to close smoothly and quietly.
-  Tilting grill: the tilting grill can be easily unhooked to move the heating element and clean the roof of the appliance in one simple step.
-  Vapor Clean: a simple cleaning function using steam to loosen deposits in the oven cavity.
-  Knobs control
-  Pizza function: The simultaneous operation of three elements ensures an optimum cooking facility when used with the Smeg pizza stone.
-  All glass inner door: All glass inner door, a single flat surface which is simple to keep clean.
-  Side lights: Two opposing side lights increase visibility inside the oven.
-  The oven cavity has 5 different cooking levels.
-  Telescopic rails: allow you to pull out the dish and check it without having to remove it from the oven entirely.
-  Ultra rapid burners: Powerful ultra rapid burners offer up to 5kw of power.
-  ...

Benefit (TT)

True-convection

The best cooking performances guaranteed by ventilated circular flow.

Multiple fans and heating elements guarantee the perfect aerodynamic heat flow, allowing homogeneous and quicker cooking inside the cavity.

Gas hob

Induction offers fast cooking and precise temperature control

Equipped with a thermocouple, the gas supply is cut off if the flame is extinguished for greater safety

Vapor Clean

By inserting water into a recess at the bottom of the cavity, steam is generated, which softens the residue and facilitates its removal

By inserting water into a recess at the bottom of the cavity, steam is generated, which softens the residue and facilitates its removal.

Touch control

Easy and intuitive timer setting with a single touch

Isothermic Cavity

The best cooking performance at the highest energy efficiency

Triple Turbine

The oven has three fans and two circular heating elements, allowing cooking with rotating heat

Tangential cooling

New cooling system with tangential fan and airflow from the door to the splashback

Soft close

The door is equipped with a specific system for silent closing

Multilevel halogen light

Internal halogen lighting on different levels guarantees excellent visibility

Telescopic guides

Easy extraction and safe insertion of trays into the oven thanks to telescopic guides

Adjustable height

Cooker top flushed with the working area thanks to adjustable feet

Removable inner glass

Internal door glasses are easily removable for complete cleaning

Multilevel cooking

Several cooking levels allow maximum flexibility of use

Cold door

During any function, the external door glass is cold, avoiding any risk of burns

AirFry (AIRFRY optional accessory)

Lighter and tastier food thanks to airfry basket

BBQ (optional accessory)

Barbeque cooking directly in the oven with the double-sided grill

Pizza stone (optional accessory)

Baking with refractory stone for soft and crispy pizza and yeast products (STONE optional accessory)

Push-pull storage compartment

More space thanks to the lower push-pull compartment, ideal for storing accessories or cooking utensils