

CPF92GMWH

Cooker size	90x60 cm
N. of cavities with energy label	2
Cavity heat source	ELECTRICITY
Hob type	Gas
Type of main oven	Thermo-ventilated
Type of second oven	Static
Cleaning system main oven	Vapor Clean
EAN code	8017709300364
Energy efficiency class	A
Energy efficiency class, second cavity	A



Aesthetics



Aesthetic	Portofino	Controls colour	Stainless steel
Design	Flush fit	No. of controls	8
Colour	White	Serigraphy colour	Black
Command panel finish	Enamelled metal	Display name	DigiScreen
Logo	Assembled st/steel	Door	With frame
Logo position	Facia below the oven	Glass type	Grey
Upstand	Yes	Handle	Smeg Portofino
Hob colour	Stainless steel	Handle Colour	White
Type of pan stands	Cast Iron	Storage compartment	Door
Type of control setting hob	Control knobs	Feet color	Black
Type of control knobs	Smeg Portofino		

Programs / Functions main oven

No. of cooking functions 8

Traditional cooking functions



Static



Circulaire



Turbo



Eco



Small grill



Large grill



Fan grill (large)



Fan assisted base

Other functions

 Defrost by time

Cleaning functions

 Vapor clean

Programs / Functions Auxiliary Oven

Cooking functions cavity 2 4

Traditional cooking functions, cavity 2

 Static

 Small grill

 Bottom

Hob technical features

UR

Total no. of cook zones 6

Front left - Gas - 2UR (dual) - 4.20 kW

Rear left - Gas - AUX - 1.00 kW

Front centre - Gas - AUX - 1.00 kW

Rear centre - Gas - Semi Rapid - 1.80 kW

Front right - Gas - Semi Rapid - 1.80 kW

Rear right - Gas - Rapid - 3.00 kW

Type of gas burners Standard

Gas safety valves Yes

Automatic electronic ignition Yes

Burner caps Matt black enamelled

Main Oven Technical Features



No. of lights 1

Fan number 1

Net volume of the cavity 70 l

Gross volume, 1st cavity 79 l

Cavity material Ever Clean enamel

No. of shelves 5

Type of shelves Metal racks

Light type Halogen

Light Power 40 W

Cooking time setting Start and Stop

Light when oven door is open Yes

Door opening Flap down

Removable door Yes

Full glass inner door Yes

Removable inner door Yes

Total no. of door glasses 3

No. of thermo-reflective door glasses 1

Safety Thermostat Yes

Cooling system Tangential

Usable cavity space dimensions (HxWxD) 360X460X425 mm

Temperature control Electronic

Lower heating element power 1200 W

Upper heating element - Power 1000 W

Grill element 1700 W

Large grill - Power 2700 W

Circular heating element - Power	2000 W
Grill type	Electric

Options Main Oven

Timer	Yes	Minimum Temperature	50 °C
End of cooking acoustic alarm	Yes	Maximum temperature	260 °C

Second Oven Technical Features



Fan number	1	Removable inner door	Yes
Net volume of the second cavity	35 l	No. total door glasses	3
Gross volume, 2nd cavity	36 l	No. thermo-reflective door glasses	1
Cavity material	Ever Clean enamel	Safety Thermostat	Yes
No. of shelves	4	Cooling system	Tangential
Type of shelves	Metal racks	Usable cavity space dimensions (HxWxD)	311x206x418 mm
No. of lights	1	Temperature control	Electro-mechanical
Light type	Incandescent	Lower heating element - power	700 W
Light Power	25 W	Upper heating element - Power	600 W
Door opening	Flap down	Grill element - power	1300 W
Removable door	Yes	Large grill - Power	1900 W
Full glass inner door	Yes	Grill type	Electric

Options Auxiliary Oven

Minimum Temperature	50 °C	Maximum temperature	245 °C
---------------------	-------	---------------------	--------

Accessories included for Main Oven & Hob



Rack with back and side stop	1	Grill mesh	1
20mm deep tray	1	Telescopic Guide rails, total Extraction	1
40mm deep tray	1		

Accessories included for Secondary Oven

Rack with back and side stop	1	Grill mesh	1
Wide baking tray	1		

Electrical Connection

Plug	Not present
Electrical connection rating	5200 W
Current	23 A
Voltage	220-240 V
Voltage 2 (V)	380-415 V

Electric cable	Installed, Single phase
Power supply cable length	120 cm
Additional connection modalities	Double and Three Phase
Frequency	50/60 Hz
Terminal block	5 poles

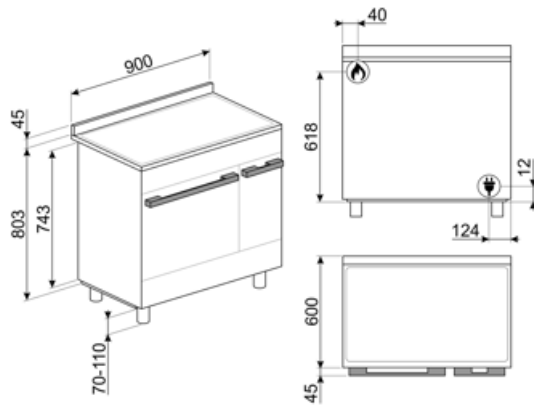

Compatible Accessories

AIRFRY

Air fryer rack AIRFRY . Ideal for recreating traditional frying in the oven, but with fewer calories and less fat. It allows you to cook quickly and simply dishes such as French fries, fried vegetables and fish, ensuring perfect browning and crispiness.



BN620-1

Enamelled tray suitable for 45cm and 60cm ovens. Depth 20 mm. Perfect for a wide range of savoury and sweet baking.



BNP608T

Teflon-coated tray, 8mm depth, to be placed on the grid



GTT

Totally extractable telescopic guides (1 level), suitable for traditional ovens. Made in stainless steel, they guarantee stability and facilitate the smooth extraction of the trays.



KITH900CPF9

Plinth, 90cm, three sides, black, suitable for CPF9 Portofino or Sinfony C9 cookers



KITPBX

Height reduction feet (850mm), st/steel, for Sinfonia and Master cookers (845-856mm)



PALPZ

Pizza shovel with folding handle. Dimensions L31.5 x H32.5 cm. Easy and convenient to use and store. Perfect for serving pizza, bread and savory pastries in a safe and professional way.



BBQ

Double sided plate BBQ. Suitable for recreating succulent and crispy dishes in the oven with the typical taste of grilled cooking. The ribbed side is particularly suitable for meats and cheeses. The smooth side for fish, seafood and vegetables.



BN640

Enamelled tray suitable for 45cm and 60cm ovens. Depth 540 mm. Perfect for cooking and roasting meat and fish in sauces. Also ideal for experimenting with lighter and crunchy side dishes

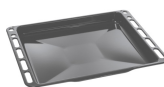

GTP

Partially extractable telescopic guides (1 level), suitable for traditional ovens. Made in stainless steel, they guarantee stability and facilitate the smooth extraction of the trays.



KITC9X9-1

Splashback kit, st/steel, 90cm, suitable for Portofino Multifunction, Master and Sinfonia cookers

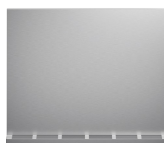

KITH95CPF9

Height extension kit with plinth, (950mm), three sides, black with feet, suitable for CPF9 Portofino and Sinfony C9 cookers



KITPD

Height extension black feet (950 mm), black, suitable for Master, Sinfonia and Portofino 90cm (914-968mm); Height extension black feet (900 mm), black, suitable for Concerto cookers with 850mm height (880-935mm)



SFLK1

Child lock



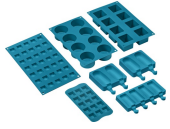

SMOLD

Set of 7 silicone moulds for ice creams, ice lollies, pralines, ice cubes or to portion food. Usable from -60°C to +230°C



STONE

Rectangular refractory stone Ideal for cooking pizzas with the same results as a typical wood-fired oven. Can also be used for baking bread, focaccias and other recipes such as pies, flans or biscuits Dimensions:L42 x H1,8 x P37,5 cm.



TPKCPF9

















Stainless steel teppanyaki plate, suitable for Portofino cookers

















WOKGHU

Cast iron WOK Support

Symbols glossary

			Heavy duty cast iron pan stands: for maximum stability and strength.
	Installation in column: Installation in column		Air cooling system: to ensure a safe surface temperatures.
	Defrost by time: Manual defrost function. At the end of the set duration, the function stops.		Triple glazed doors: Number of glazed doors.
	Ever Clean Enamel: Ever Clean enamel is applied electrostatically, corner to corner and edge to edge to prevent cracking or cracks over time. It is a particular pyrolytic enamel, resistant to acids which, in addition to being pleasantly bright, promotes greater cleaning of the oven walls, thanks to its lower porosity. It is baked at over 850 ° C and slowly polymerized at a scientifically determined rate to ensure uniform depth and strength Ever Clean enamel creates an impeccable finish both on the inside of the oven and on the trays, making the surfaces of the oven incredibly easy to maintain over time as it reduces the adhesion of fat during cooking		Fan assisted base: the mix of fan and lower heating element alone allows to finish cooking foods already cooked on the surface but not internally more quickly. This system is recommended to finish cooking foods that are already well cooked on the surface, but not internally, which therefore require a moderate higher heat. Ideal for any type of food.
	Static: Traditional cooking suitable for the preparation of one dish at a time. The fan is not active and the heat comes from below and from above at the same time. Static cooking is slower and more delicate, ideal in order to get well cooked and dry dishes even inside. Ideal for cooking all types of roasts, fatty meats, bread, filled cakes.		Base: the heat comes only from the bottom of the cavity. The fan is not active. Ideal for sweet and savory pies, cobblers and pizzas. Designed to complete cooking and make food more crunchy This symbol in gas ovens indicates the gas burner.
	Circulaire: it is the perfect function for cooking all types of dishes in a more delicate way. The heat comes from the back of the oven and is distributed quickly and evenly The fan is active. It is also ideal for cooking on multiple levels without mixing smells and flavors.		ECO: low energy consumption cooking: this function is particularly suitable for cooking on a single shelf with low energy consumption. It is recommended for all types of food except those that can generate a lot of moisture (for example vegetables). To achieve maximum energy savings and reduce time, it is recommended to put the food in the oven without preheating the cooking compartment
	Grill: Very intense heat coming only from above from a double heating element. The fan is not active. Provides excellent grilling and gratinating results. Used at the end of cooking, it gives a uniform browning to dishes.		Half grill: For rapid cooking and browning of foods. Best results can be obtained by using the top shelf for small items, the lower shelves for larger ones, such as chops or sausages. For half grill heat is generated only at the centre of the element, so is ideal for smaller quantities.
	Fan grill: very intense heat coming only from above from a double heating element The fan is active. It allows the optimal grilling of thickest meats. Ideal for large cuts of meat.		Light

-
-  Turbo: the heat comes from 3 directions: above, below and from the back of the oven The fan is active. It allows quick cooking, even on several shelves without mixing the aromas. Ideal for large volumes or foods that require intense cooking.
 -  The inner door glass: can be removed with a few quick movements for cleaning.
 -  Automatic opening: some models have Automatic opening door when the cycle is finished which is a perfect solution for handle-less kitchen units as no handle is needed. For safety reasons, the door locks automatically when the machine is in use to avoid it being opened inadvertently.
 -  The oven cavity has 5 different cooking levels.
 -  Electronic control: Allows you to maintain temperature inside the oven with the precision 2-3 ° C. This enables to cook meals that are very sensitive to temperature changes, such as cakes, souffles, puddings.
 -  Vapor Clean: a simple cleaning function using steam to loosen deposits in the oven cavity.
 -  The capacity indicates the amount of usable space in the oven cavity in litres.
 -  Knobs control
 -  All glass inner door: All glass inner door, a single flat surface which is simple to keep clean.
 -  Side lights: Two opposing side lights increase visibility inside the oven.
 -  The oven cavity has 4 different cooking levels.
 -  Telescopic rails: allow you to pull out the dish and check it without having to remove it from the oven entirely.
 -  Ultra rapid burners: Powerful ultra rapid burners offer up to 5kw of power.
 -  The capacity indicates the amount of usable space in the oven cavity in litres.
 -  4.3 inch display with LED technology, usability with knobs + 3 touch keys

Benefit (TT)

Gas hob

Gas provides permanent control of the heat source and the temperature change is immediate

Equipped with a thermocouple, the gas supply is cut off if the flame is extinguished for greater safety.

Vapor Clean

By inserting water into a recess at the bottom of the cavity, steam is generated, which softens the residue and facilitates its removal

By inserting water into a recess at the bottom of the cavity, steam is generated, which softens the residue and facilitates its removal.

Touch control

Easy and intuitive timer setting with a single touch

Storage compartment

More space thanks to the lower compartment, ideal for storing accessories or cooking utensils

True-convection

The best cooking performances guaranteed by ventilated circular flow

Multiple fans and heating elements guarantee the perfect aerodynamic heat flow, allowing homogeneous and quicker cooking inside the cavity.

Multilevel cooking

Several cooking levels allow maximum flexibility of use

Multilevel halogen light

Internal halogen lighting on different levels guarantees excellent visibility

Removable inner glass

Internal door glasses are easily removable for complete cleaning

Tangential cooling

New cooling system with tangential fan and airflow from the door to the splashback

Electronic control

Electronic control for timely temperature management and heat uniformity

Telescopic guides

Easy extraction and safe insertion of trays into the oven thanks to telescopic guides

Isothermic Cavity

The best cooking performance at the highest energy efficiency

Pizza stone (optional accessory)

Baking with refractory stone for soft and crispy pizza and yeast products (STONE optional accessory)

BBQ (optional accessory)

Barbeque cooking directly in the oven with the double-sided grill (BBQ optional accessory)

Adjustable height

Cooker top flushed with the working area thanks to adjustable feet

AirFry (AIRFRY optional accessory)

Lighter and tastier food thanks to airfry basket (optional accessory)

Cold door

During any function, the external door glass is cold, avoiding any risk of burns

Single turbine

The oven has a fan equipped with a circular heating element allowing cooking with rotating heat