

# CPF92IMWH

Cooker size	90x60 cm
N. of cavities with energy label	2
Cavity heat source	Electric
Hob type	Induction
Type of main oven	Thermo-ventilated
Type of second oven	Static
Cleaning system main oven	Vapor Clean
EAN code	8017709300395
Energy efficiency class	A
Energy efficiency class, second cavity	A



## Aesthetics

Aesthetics	Portofino	No. of controls	8
Colour	White	Serigraphy colour	Black
Design	Flush fit	Handle	Smeg Portofino
Door	With frame	Handle Colour	White
Hob colour	Stainless steel	Glass type	Grey
Command panel finish	Enamelled metal	Feet	Black
Control knobs	Smeg Portofino	Storage compartment	Door
Controls colour	Stainless steel	Logo	Assembled st/steel
Display	Touch	Logo position	Facia below the oven

## Programs / Functions

No. of cooking functions 7

Traditional cooking functions



Static



Fan assisted



Circulaire



ECO



Large grill



Fan grill (large)



Fan assisted base

Cleaning functions



Vapor Clean

## Other functions

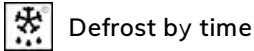

## Programs / Functions Auxiliary Oven

Cooking functions cavity 2 3  
 Traditional cooking functions, cavity 2



## Hob technical features

Total no. of cook zones 5

Front left - Induction - multizone - 2.10 kW - Booster 2.30 kW - 21.0x19.0 cm

Rear left - Induction - multizone - 1.60 kW - Booster 1.85 kW - 21.0x19.0 cm

Central - Induction - single - 2.30 kW - Booster 3.00 kW - Ø 27.0 cm

Rear right - Induction - single - 1.20 kW - Booster 1.40 kW - Ø 18.0 cm

Front right - Induction - single - 2.30 kW - Booster 3.00 kW - Ø 21.0 cm

## Main Oven Technical Features



<b>No. of lights</b>	1	<b>Removable inner door</b>	Yes
<b>Fan number</b>	1	<b>Total no. of door glasses</b>	3
<b>Net volume of the cavity</b>	70 litres	<b>No. of thermo-reflective door glasses</b>	2
<b>Gross volume, 1st cavity</b>	79 l	<b>Safety Thermostat</b>	Yes
<b>Cavity material</b>	Easy clean enamel	<b>Cooling system</b>	Tangential
<b>Shelf positions</b>	5	<b>Usable cavity space dimensions (HxWxD)</b>	360X460X425 mm
<b>Type of shelves</b>	Metal racks	<b>Temperature control</b>	Electronic
<b>Light type</b>	Halogen	<b>Lower heating element power</b>	1200 W
<b>Light power</b>	40 W	<b>Upper heating element - Power</b>	1000 W
<b>Cooking time setting</b>	Start and Stop	<b>Grill element</b>	1700 W
<b>Light when oven door is open</b>	Yes	<b>Large grill - Power</b>	2700 W
<b>Door opening</b>	Flap down	<b>Circular heating element - Power</b>	2000 W
<b>Removable door</b>	Yes	<b>Grill type</b>	Electric
<b>Full glass inner door</b>	Yes		

## Options Main Oven

<b>Timer</b>	Yes	<b>Minimum Temperature</b>	50 °C
<b>End of cooking acoustic alarm</b>	Yes	<b>Maximum temperature</b>	260 °C

## Second Oven Technical Features



<b>Fan number</b>	1	<b>Removable inner door</b>	Yes
<b>Net volume of the second cavity</b>	35 litres	<b>No. total door glasses</b>	3
<b>Gross volume, 2nd cavity</b>	36 l	<b>No. thermo-reflective door glasses</b>	2
<b>Cavity material</b>	Easy clean enamel	<b>Safety Thermostat</b>	Yes
<b>Shelf positions</b>	4	<b>Cooling system</b>	Tangential
<b>Type of shelves</b>	Metal racks	<b>Usable cavity space dimensions (HxWxD)</b>	311x206x418 mm
<b>No. of lights</b>	1	<b>Temperature control</b>	Electro-mechanical
<b>Light type</b>	Incandescent	<b>Lower heating element - power</b>	700 W
<b>Light power</b>	25 W	<b>Upper heating element - Power</b>	600 W
<b>Door opening</b>	Flap down	<b>Grill element - power</b>	1300 W
<b>Removable door</b>	Yes	<b>Large grill - Power</b>	1900 W
<b>Full glass inner door</b>	Yes	<b>Grill type</b>	Electric

## Options Auxiliary Oven

<b>Minimum Temperature</b>	50 °C	<b>Maximum temperature</b>	245 °C
----------------------------	-------	----------------------------	--------

## Accessories included for Main Oven & Hob



<b>Rack with back and side stop</b>	1	<b>Grill mesh</b>	1
<b>20mm deep tray</b>	1	<b>Telescopic Guide rails, total Extraction</b>	1
<b>40mm deep tray</b>	1		

## Accessories included for Secondary Oven

<b>Rack with back and side stop</b>	1	<b>Grill mesh</b>	1
<b>Wide baking tray</b>	1		

## Electrical Connection

<b>Nominal power</b>	11000 W	<b>Frequency</b>	50/60 Hz
<b>Current</b>	33 A	<b>Cable testing</b>	Yes
<b>Voltage</b>	220-240 V	<b>Terminal block</b>	5 poles
<b>Voltage 2 (V)</b>	380-415 V		

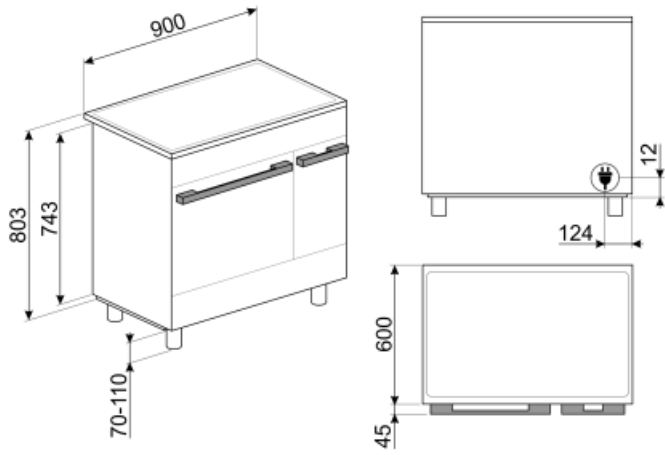

## Not included accessories

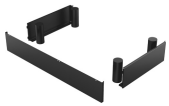

### KITH95CPF9

Height extension kit (950 mm), suitable for Portofino cookers



### SFLK1

Child lock



### PRTX

Refractory pizza stone with handles. D=35cm Not suitable for microwave ovens. Suitable for gas ovens, to be put on the griddle.



### GRILLPLATE

Universal griddle for induction, gas, ceramic and electric hobs. Non-stick surface ideal for cooking meat, cheese and vegetables. Dimensions: 410 x 240 mm.



### KITH900CPF9

Height extension kit (950 mm), suitable for TR4110 cookers



### SCRP

Induction and ceramic hobs and teppanyaki scraper



### BBQ

Double sided plate BBQ. Suitable for recreating succulent and crispy dishes in the oven with the typical taste of grilled cooking. The ribbed side is particularly suitable for meats and cheeses. The smooth side for fish, seafood and vegetables.



### AIRFRY

Air fryer rack AIRFRY . Ideal for recreating traditional frying in the oven, but with fewer calories and less fat. It allows you to cook quickly and simply dishes such as French fries, fried vegetables and fish, ensuring perfect browning and crispiness.



### GTP

\*\*Partially extractable telescopic guides (1 level)\*\* Extraction: 300 mm  
Material: Stainless steel AISI 430 polished



### BNP608T

Teflon-coated tray, 8mm depth, to be placed on the grid



### KITPBX

Height reduction feet (850 mm)



### BN620-1

Enamelled tray, 20mm deep



### KITPD

Height extension black feet (950 mm) for cookers



### TPKPLATE

Universal plate for induction, gas, ceramic and electric hobs. Non-stick surface ideal for cooking fish, eggs and vegetables. Dimensions: 410 X 240 mm.

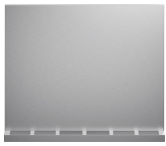

**KITC9X9-1**

Splashback, 90x75 cm, stainless steel, suitable for Portofino and Symphony cookers



**BN640**

Enamelled tray, 40mm deep



**GTT**



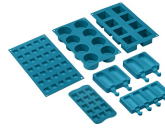















\*\*Totally extractable telescopic guides (1 level)\*\* Extraction: 433 mm  
Material: Stainless steel AISI 430 polished











**SMOLD**

Set of 7 silicone moulds for ice creams, ice lollies, pralines, ice cubes or to portion food. Usable from -60°C to +230°C

## Symbols glossary

 <p>Air cooling system: to ensure a safe surface temperatures.</p>	 <p>Defrost by time: with this function the time of thawing of foods are determined automatically.</p>
 <p>A: Product drying performance, measured from A+++ to D / G depending on the product family</p>	 <p>Triple glazed doors: Number of glazed doors.</p>
 <p>ECO-logic: option allows you to restrict the power limit of the appliance real energy saving.</p>	 <p>Enamel interior: The enamel interior of all Smeg ovens have a special antacid lining which helps keep the interior clean by reducing the amount of cooking grease adhering to it.</p>
 <p>Circogas: In gas ovens the fan distributes the heat quickly and evenly throughout the oven cavity, avoiding flavour transfer when cooking a number of different dishes at the same time. In electric ovens this combination completes cooking more quickly of foods that are ready on the surface, but that require more cooking inside, without further browning.</p>	 <p>Fan with upper and lower elements: The elements combined with the fan aim to provide more uniform heat, a similar method to conventional cooking, so pre-heat is required. Most suitable for items requiring slow cooking methods.</p>
 <p>Upper and lower element only: a traditional cooking method best suited for single items located in the centre of the oven. the top pf the oven will always be hottest. Ideal for roast, fruit cakes, bread etc.</p>	 <p>Lower heating element only: This function is ideal for foods that require extra base temperature without browning, e.g. pastry dishes, pizza. Also suitable for slow cooking of stews and casseroles.</p>
 <p>Circulaire: The combination of the fan and circular element around it gives a hot air cooking method. This provides many benefits including no preheat if cook time is more than 20 minutes, no flavour transfer when cooking different foods at the same time, less energy, and shorter cook times. Good for all types of food.</p>	 <p>ECO: The combination of the grill, fan and lower element is particularly suitable for cooking small quantities of food.</p>
 <p>Grill element: Using of grill gives excellent results when cooking meat of medium and small portions, especially when combined with a rotisserie (where possible). Also ideal for cooking sausages and bacon.</p>	 <p>Half grill: For rapid cooking and browning of foods. Best results can be obtained by using the top shelf for small items, the lower shelves for larger ones, such as chops or sausages. For half grill heat is generated only at the centre of the element, so is ideal for smaller quantities.</p>
 <p>Fan with grill element: The fan reduces the fierce heat from the grill, providing an excellent method of grilling various foods, chops, steaks, sausages etc. giving even browning and heat distribution, without drying out the food. The top two levels recommended for use, and the lower part of the oven can be used to keep items warm at the same time, an excellent facility when cooking a grilled breakfast. Half grill (centre portion only) is ideal for small quantities of food.</p>	 <p>Induction: The work of these hobs is based on the principle of electromagnetic induction. The heat is generated directly in the bottom of the pan during its contact with the hob.</p>
 <p>All glass inner door: All glass inner door, a single flat surface which is simple to keep clean.</p>	 <p>The inner door glass: can be removed with a few quick movements for cleaning.</p>

- 
- |  |  |
|--|--|
|  <p>Side lights: Two opposing side lights increase visibility inside the oven.</p>   |  <p>The oven cavity has 4 different cooking levels.</p>   |
|  <p>The oven cavity has 5 different cooking levels.</p>  |  <p>Telescopic rails: allow you to pull out the dish and check it without having to remove it from the oven entirely.</p> |
|  <p>Electronic control: Allows you to maintain temperature inside the oven with the precision 2-3 ° C. This enables to cook meals that are very sensitive to temperature changes, such as cakes, souffles, puddings.</p> |  <p>Vapor Clean: a simple cleaning function using steam to loosen deposits in the oven cavity.</p>                        |
|  <p>The capacity indicates the amount of usable space in the oven cavity in litres.</p>  |  <p>The capacity indicates the amount of usable space in the oven cavity in litres.</p>                                   |