

CPF92IMX

Categorie fornuis	90x60 cm
Aantal ovens met energielabel	2
Cavity heat source	Elektrisch
Type kookplaat	Inductie
Type primaire oven	Thermogeventileerd
Type secundaire oven	Statisch
Reinigingssysteem primaire oven	Vapor Clean
EAN-code	8017709297343
Energie-efficiëntieklasse	A
Energie-efficiëntieklasse, tweede oven	A



Design



Afwerking bedieningspaneel	Vingervlek vrij roestvrijstaal	Aantal bedieningsknoppen	8
Esthetiek	Portofino	Kleur serigrafie	Zwart
Logo	Assembled st/steel	Display	DigiScreen
Kleur	Roestvrij staal	Deur	Met kader
Positie logo	Strook onder de oven	Type glas	Grijs
Afwerking	Geborsteld	Handgreep	Smeg Portofino
Kleur kookplaat	Roestvrij staal	Kleur handgreep	Geborsteld roestvrijstaal
Type bediening	Bedieningsknoppen	Opbergruimte	Klep
Bedieningsknoppen	Smeg Portofino	Pootjes	Zwart
Kleur knoppen	Roestvrij staal		

Programma's / functies

Aantal kookfuncties 7
Traditionele kookfuncties



Statisch



Geventileerd



Circulaire



ECO

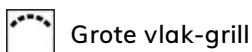

Grote vlak-grill

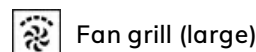

Fan grill (large)

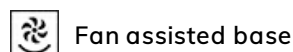

Fan assisted base

Overige functies

 Ontdooien op tijd

Schoonmaak functie

 Vapor Clean

Programma's / functies secundaire oven

Kookfuncties ovenruimte 2 3

Traditionele kookfuncties, ovenruimte 2

 Statisch

 Kleine grill

 Bodem

Technische specificaties kookplaat

Totaal aantal kookzones 5

Linksvoor - Inductie - Multizone - 2.10 kW - Booster 2.30 kW - 21.0x19.0 cm

Linksachter - Inductie - Multizone - 1.60 kW - Booster 1.85 kW - 21.0x19.0 cm

Midden - Inductie - enkel - 2.30 kW - Booster 3.00 kW - Ø 27.0 cm

Rechtsachter - Inductie - enkel - 1.20 kW - Booster 1.40 kW - Ø 18.0 cm

Rechtsvoor - Inductie - enkel - 2.30 kW - Booster 3.00 kW - Ø 21.0 cm

Number of Flexible zones 1

Technische specificaties primaire oven



Aantal lampen	1	Uitneembaar glas binnendeur	Ja
Aantal ventilatoren	1	Aantal ruiten ovendeur	3
Netto inhoud	70 l	Aantal thermo-reflecterende ruiten	2
Bruto inhoud 1e oven	79 l	Veiligheidsthermostaat	Ja
Materiaal ovenruimte	Ever Clean emaille	Koelsysteem	Mantelkoeling
Aantal kookniveaus	5	Afmetingen bruikbare interne ovenruimte (hxbxd)	360X460X425 mm
Type ovenrekken	Metalen zijsteunen	Temperatuurregeling	Elektronisch
Soort verlichting	Halogeen	Onderwarmte - vermogen	1200 W
Vermogen lamp	40 W	Bovenwarmte - vermogen	1000 W
Instelling kooktijd	Start en stop	Grill - vermogen	1700 W
Automatische inschakeling verlichting bij openen deur	Ja	Grote vlakgrill - vermogen	2700 W
Deur openen	naar beneden	Circulatie - vermogen	2000 W
Uitneembare ovendeur	Ja	Type grill	Elektrisch
Volledig glazen binnendeur	Ja		

Opties primaire oven

Timer	Ja	Minimum temperatuur	50 °C
Akoestisch signaal einde kooktijd	Ja	Maximum temperatuur	260 °C

Technische specificaties secundaire oven



Aantal ventilatoren	1	Uitneembaar glas binnendeur	Ja
Netto inhoud (l) oven 2	35 l	Aantal ruiten ovendeur	3
Bruto inhoud, 2e oven	36 l	Aantal thermo- reflecterende ruiten	2
Materiaal ovenruimte	Ever Clean emaille	Veiligheidsthermostaat	Ja
Aantal kookniveaus	4	Koelsysteem	Mantelkoeling
Type ovenrekken	Metalen zijsteunen	Afmetingen bruikbare interne ovenruimte (hxbxd)	311x206x418 mm
Aantal lampen	1	Temperatuurregeling	Elektro-mechanisch
Soort verlichting	Gloeilamp	Onderwarmte - vermogen	700 W
Vermogen lamp	25 W	Bovenwarmte - vermogen	600 W
Deur openen	naar beneden	Grill - vermogen	1300 W
Uitneembare ovendeur	Ja	Grote vlakgrill - vermogen	1900 W
Volledig glazen binnendeur	Ja	Type grill	Elektrisch

Opties secundaire oven

Minimum temperatuur	50 °C	Maximum temperatuur	245 °C
---------------------	-------	---------------------	--------

Meegeleverde accessoires primaire oven en kookplaat



Rek met achter- en zijstop	1	Inzetrooster	1
Bakplaat (20 mm)	1	Telescopische geleiders, geheel uitschuifbaar	1
Bakplaat (40 mm)	1		

Meegeleverde accessoires secundaire oven

Rek met achter- en zijstop	1	Inzetrooster	1
Bakplaat	1		

Elektrische aansluiting

Aansluitwaarde	11000 W
Stroom	33 A
Spanning	220-240 V
Spanning 2 (V)	380-415 V
Electric cable	Installed, Single phase

Type stroomkabel	Double and Three Phase
Frequentie	50/60 Hz
Aansluitkast	5 polig
Stekker	Nee

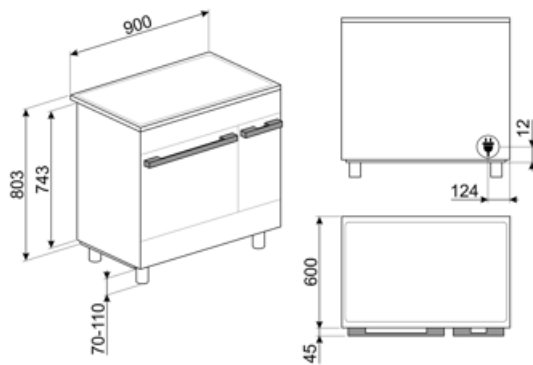

Compatibele Accessoires

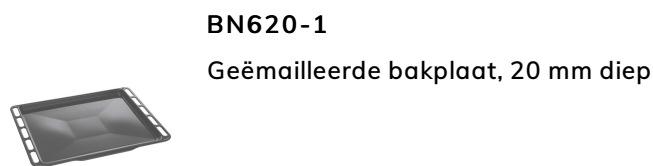

BN620-1

Geëmailleerde bakplaat, 20 mm diep

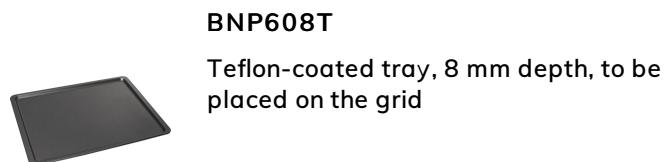

BNP608T

Teflon-coated tray, 8 mm depth, to be placed on the grid

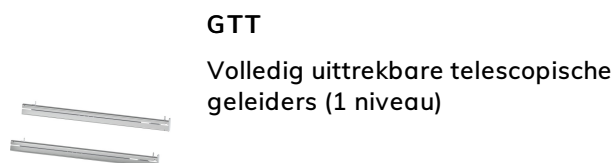

GTT

Volledig uittrekbare telescopische geleiders (1 niveau)

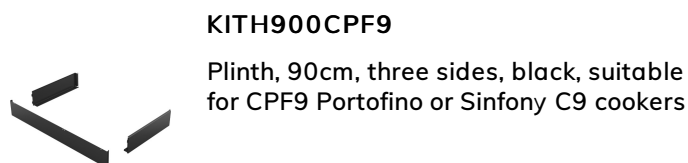

KITH900CPF9

Plinth, 90cm, three sides, black, suitable for CPF9 Portofino or Sinfony C9 cookers

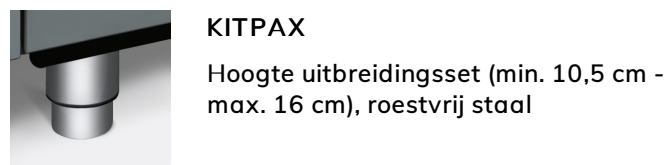

KITPAX

Hoogte uitbreidingsset (min. 10,5 cm - max. 16 cm), roestvrij staal

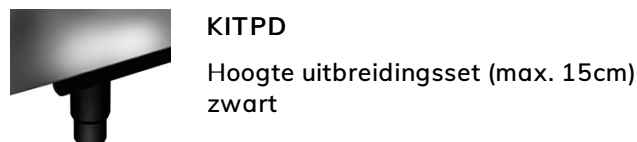

KITPD

Hoogte uitbreidingsset (max. 15cm) zwart



SFLK1

Kinderslot



BN640

Geëmailleerde bakplaat, 40 mm diep

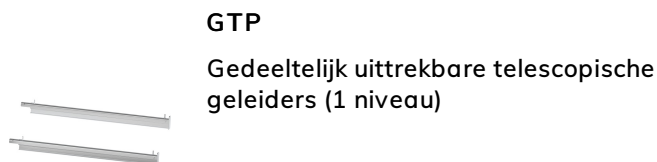

GTP

Gedeeltelijk uittrekbare telescopische geleiders (1 niveau)

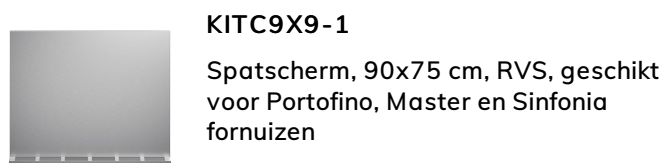

KITC9X9-1

Spatscherm, 90x75 cm, RVS, geschikt voor Portofino, Master en Sinfonia fornuizen

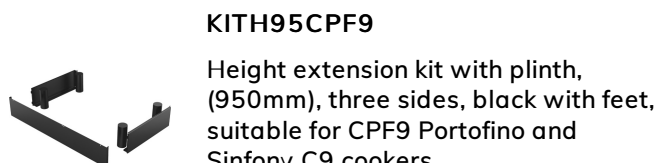

KITH95CPF9

Height extension kit with plinth, (950mm), three sides, black with feet, suitable for CPF9 Portofino and Sinfony C9 cookers

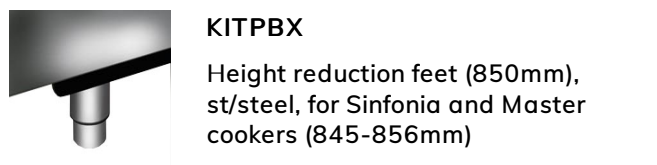

KITPBX

Height reduction feet (850mm), st/steel, for Sinfonia and Master cookers (845-856mm)

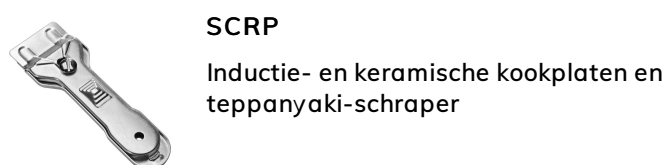

SCRP

Inductie- en keramische kookplaten en teppanyaki-schraper

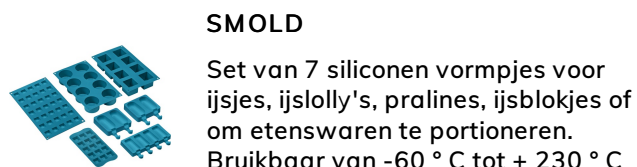

SMOLD

















Set van 7 siliconen vormpjes voor ijsjes, ijslolly's, pralines, ijsblokjes of om etenswaren te portioneren. Bruikbaar van -60 ° C tot + 230 ° C

















STONE

Rectangular refractory stone Ideal for cooking pizzas with the same results as a typical wood-fired oven. Can also be used for baking bread, focaccias and other recipes such as pies, flans or biscuits Dimensions:L42 x H1,8 x P37,5 cm.



Symbols glossary

 <p>A: Droogprestaties van het product, gemeten vanaf A +++ tot D / G afhankelijk van de productfamilie</p>	 <p>Installation in column: Installation in column.</p>
 <p>Luchtkoelsysteem: om een veilig oppervlak te garanderen temperaturen.</p>	 <p>Ontdooien op tijd: met deze functie wordt automatisch het tijdstip van ontdooien van voedsel bepaald</p>
 <p>Deuren met driedubbele beglazing: aantal glazen deuren.</p>	 <p>ECO-logic: optie stelt u in staat om de vermogenslimiet van de werkelijke energiebesparing van het apparaat te beperken</p>
 <p>Geëmailleerde binnenkant: De geëmailleerde binnenkant van alle Smeg-ovens heeft een speciale antacidumvoering die helpt om de binnenkant schoon te houden door de hoeveelheid kookvet te verminderen.</p>	 <p>Vingerafdrukbestendig roestvrij staal: Vingerafdrukbestendig roestvrij staal zorgt ervoor dat roestvrij staal er zo goed als nieuw uitziet.</p>
 <p>Fan assisted base: the mix of fan and lower heating element alone allows to finish cooking foods already cooked on the surface but not internally more quickly. This system is recommended to finish cooking foods that are already well cooked on the surface, but not internally, which therefore require a moderate higher heat. Ideal for any type of food.</p>	 <p>Ventilator met bovenste en onderste elementen: de elementen in combinatie met de ventilator zijn bedoeld om een meer gelijkmatige warmte te bieden, een methode die vergelijkbaar is met conventioneel koken, dus voorverwarmen is vereist. Het meest geschikt voor items die langzaam koken vereisen.</p>
 <p>De ovenruimte wordt tegelijk door het onder- en bovinelement verwarmt. De hitteverdeling over het gerecht is afhankelijk van het niveau waarop men dit plaatst. Geschikt voor bakken op 1 niveau. Gerechten: alle ovenschotels, vlees, gevogelte, brood, (gevulde) taarten. Speciaal: gans en eend (bevatten veel vet).</p>	 <p>De ovenruimte wordt uitsluitend verhit door het onderelement. Voor gerechten die een hoge basistemperatuur behoeven, heeft deze bakstand weinig tot geen invloed op de korst aan de bovenzijde. Geschikt voor bakken op 1 niveau, ideaal voor deeggerechten die moeten rijzen (bijv. pizza). Bij gevulde taarten zal de deegbodem beter droog blijven.</p>
 <p>Circulaire: it is the perfect function for cooking all types of dishes in a more delicate way. The heat comes from the back of the oven and is distributed quickly and evenly. The fan is active. It is also ideal for cooking on multiple levels without mixing smells and flavors.</p>	 <p>ECO: low energy consumption cooking: this function is particularly suitable for cooking on a single shelf with low energy consumption. It is recommended for all types of food except those that can generate a lot of moisture (for example vegetables). To achieve maximum energy savings and reduce time, it is recommended to put the food in the oven without preheating the cooking compartment.</p>
 <p>De warmte wordt geproduceerd door het grill- en bovinelement. Verhitting over het volledige oppervlak. De thermostaat wordt, afhankelijk van het gerecht, in de regel op de maximale stand gezet. Bij een korte baktijd kan de ovendeur gesloten blijven; bij langere baktijd blijft deze gedeeltelijk geopend. Voor vleesgerechten (klein- en middelgroot), vleespennen, vis, groenten, gratineren etc.</p>	 <p>De warmte is alleen afkomstig van het grill-element. Verhitting over een kleiner oppervlak. Te gebruiken als de grote vlak-grill, maar voor kleinere hoeveelheden</p>

- | | |
|--|--|
|  <p>Ventilator met grillelement: De ventilator vermindert de felle hitte van de grill en biedt een uitstekende methode om verschillende soorten voedsel, karbonades, steaks, worstjes enz. Te grillen, waardoor het gelijkmatig bruin wordt en de warmte wordt verdeeld, zonder het voedsel uit te drogen. De bovenste twee niveaus die voor gebruik worden aanbevolen, en het onderste deel van de oven kunnen worden gebruikt om gerechten tegelijkertijd warm te houden, een uitstekende mogelijkheid bij het bereiden van een gegrild ontbijt. Halve grill (alleen middengedeelte) is ideaal voor kleine hoeveelheden voedsel.</p> |  <p>Light</p> |
|  <p>Induction: The work of these hobs is based on the principle of electromagnetic induction. The heat is generated directly in the bottom of the pan during its contact with the hob.</p> |  <p>All glass inner door: All glass inner door, a single flat surface which is simple to keep clean.</p> |
|  <p>The inner door glass: can be removed with a few quick movements for cleaning.</p> |  <p>verlichting</p> |
|  <p>Automatic opening: some models have Automatic opening door when the cycle is finished which is a perfect solution for handle-less kitchen units as no handle is needed. For safety reasons, the door locks automatically when the machine is in use to avoid it being opened inadvertently.</p> |  <p>The oven cavity has 4 different cooking levels.</p> |
|  <p>The oven cavity has 5 different cooking levels.</p> |  <p>Telescopic rails: allow you to pull out the dish and check it without having to remove it from the oven entirely.</p> |
|  <p>Electronic control: Allows you to maintain temperature inside the oven with the precision 2-3 ° C. This enables to cook meals that are very sensitive to temperature changes, such as cakes, souffles, puddings.</p> |  <p>Vapor Clean: a simple cleaning function using steam to loosen deposits in the oven cavity.</p> |
|  <p>The capacity indicates the amount of usable space in the oven cavity in litres.</p> |  <p>The capacity indicates the amount of usable space in the oven cavity in litres.</p> |
|  <p>4.3 inch display with LED technology, usability with knobs + 3 touch keys</p> |  <p>Knobs control</p> |
|  <p>Automatic merge of zones for a bigger area</p> | |

Benefit (TT)

Induction hob

Inductie zorgt voor snel koken met nauwkeurige temperatuurregeling

Inductie is veilig, nauwkeurig en eenvoudig in gebruik en onderhoud – mits gebruikt met geschikt kookgerei

Vapor Clean

Door water in een uitsparing onderin de oven te plaatsen, ontstaat er stoom die aangekoekte resten losweekt en het schoonmaken vergemakkelijkt

Door water in een uitsparing onderin de ovenruimte te plaatsen, ontstaat er stoom die aangekoekte resten losweekt en het schoonmaken vergemakkelijkt

Touch control

De timer stel je eenvoudig en intuïtief in met één enkele aanraking

Storage compartment

Meer opbergruimte in het onderste compartiment – ideaal voor accessoires of kookgerei

True-convection

Optimale kookprestaties dankzij een ventilatiesysteem met circulerende hetelucht

Meerdere ventilatoren en verwarmingselementen zorgen voor een perfecte aerodynamische luchtstroom, waardoor gerechten sneller en gelijkmatig garen in de ovenruimte.

Multilevel cooking

Meerdere bakkiveaus zorgen voor maximale flexibiliteit tijdens het koken

Multilevel halogen light

Interne halogeenverlichting op meerdere niveaus zorgt voor perfect zicht op elk gerecht

Removalble inner glass

De binnenste ovenglaslagen zijn eenvoudig te verwijderen voor grondige reiniging

Tangential cooling

Nieuw koelsysteem met tangentiële ventilator en luchtstroom van deur tot achterwand voor betere temperatuurcontrole

Electronic control

Elektronische temperatuurregeling voor precieze controle en gelijkmatige warmteverdeling

Telescopic guides

Dankzij telescopische geleiders haal je bakplaten veilig en moeiteloos in en uit de oven

Adjustable height

Het kookoppervlak ligt gelijk met het werkblad dankzij verstelbare pootjes

AirFry (AIRFRY optional accessory)

Lichter en krokanter resultaat met het airfry-mandje (optioneel accessoire)

Cold door

Het buitenste glas van de ovendeur blijft koud tijdens gebruik, wat brandwonden voorkomt

Pizza stone (optional accessory)

Bakken op vuurvaste steen voor luchtige en krokante pizza's en deegwaren (optioneel STONE-accessoire)

BBQ (optional accessory)

Barbecue-effect in de oven met het dubbelzijdige grillrooster (optioneel BBQ-accessoire)

Isothermic Cavity

De oven heeft een ventilator met een circulair verwarmingselement voor gelijkmatige heteluchtcirculatie

Single turbine

De oven heeft een ventilator met een circulair verwarmingselement voor gelijkmatige heteluchtcirculatie