

CPF9GMR

Cooker size	90x60 cm
N.º de cavidades com rótulo energético	1
Fonte de calor da cavidade	ELECTRICITY
Hob type	Gas
Tipo de forno principal	Thermo-ventilated
Sistema de limpeza no forno principal	Vapor Clean
EAN code	8017709225742
Energy efficiency class	A+



Aesthetics











Aesthetic	Portofino	Controls colour	Stainless steel
Design	Flush fit	No. of controls	8
Colour	Red	Cor da serigrafia	Serigrafia em preto
Command panel finish	Enamelled metal	Display	TFT
Logo	Logotipo aplicado	Door	With frame
Posição do logotipo	Logotipo no painel abaixo do forno	Glass type	Grey
Upstand	Yes	Handle	Smeg Portofino
Cor da placa	Stainless steel	Handle Colour	coloured
Type of pan stands	Cast Iron	Storage compartment	Push pull
Type of control setting	Control knobs	Feet	Black
Control knobs	Smeg Portofino	Plinth	Black

Programs / Functions

No. of cooking functions 9

Traditional cooking functions

 Static	 Fan assisted	 Circulaire
 Turbo	 Eco	 Large grill
 Fan grill (large)	 Base	 Fan assisted bottom

Other functions



Defrost by time



Defrost by weight



Proving



Sabbath

Recipes No

Cleaning functions



Vapor clean

Customizable recipes No

Automatic programs 20

Hob technical features



Total no. of cook zones 6

Front left - Gas - 2UR (dual) - 4.20 kW

Rear left - Gas - AUX - 1.00 kW

Front centre - Gas - AUX - 1.00 kW

Rear centre - Gas - Semi Rapid - 1.80 kW

Front right - Gas - Semi Rapid - 1.80 kW

Rear right - Gas - Rapid - 3.00 kW

Type of gas burners Standard

Gas safety valves Yes

Automatic electronic ignition Yes

Burner caps Matt black enamelled

Main Oven Technical Features



No. of lights 2

Fan number 3

Net volume of the cavity 115 l

Gross volume, 1st cavity 129 l

Cavity material Ever Clean enamel

No. of shelves 5

Type of shelves Metal racks

Roof Liner No

Light type Halogen

Light Power 40 W

Cooking time setting Start and Stop

Light when oven door is open Yes

Door opening Flap down

Removable door Yes

Full glass inner door Yes

Removable inner door Yes



Total no. of door glasses 3

No. of thermo-reflective door glasses 2

Safety Thermostat Yes

Heating suspended when door is opened Yes

Cooling system Tangential

Usable cavity space dimensions (HxWxD) 371x724x418 mm

Temperature control Electronic

Lower heating element power 1700 W

Upper heating element - Power 1200 W

Grill element 1700 W

Large grill - Power 2900 W

Circular heating element - Power 1500 W

Grill type Electric

Tilting grill	Yes
Soft Close system	Yes

Options Main Oven

Timer	Yes	Minimum Temperature	50 °C
End of cooking acoustic alarm	Yes	Maximum temperature	280 °C

Accessories included for Main Oven & Hob

Cast iron wok support	1	40mm deep tray	1
TOP Oven grid with back stop	1	Grill mesh	1
20mm deep tray	1		

Electrical Connection

Plug	No	Comprimento do cabo de alimentação	120 cm
Electrical connection rating	3200 W	Frequency	50/60 Hz
Current	14 A	Bloco de terminais	3 polos
Voltage	220-240 V		

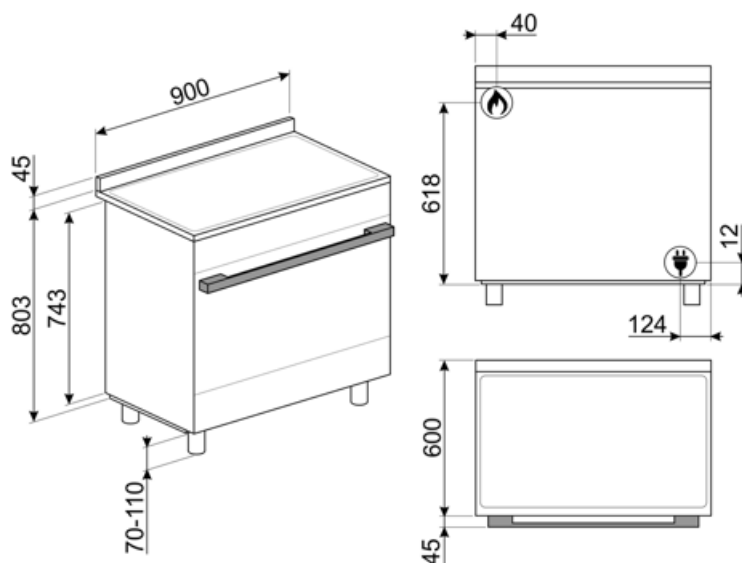

Compatible Accessories

AIRFRY9

Air fryer rack AIRFRY . Ideal for recreating traditional frying in the oven, but with fewer calories and less fat. It allows you to cook quickly and simply dishes such as French fries, fried vegetables and fish, ensuring perfect browning and crispiness.



BN920

GTP

** Guias telescópicas parcialmente extraíveis (1 nível)** Extração: 300 mm
Material: Aço inoxidável AISI 430 polido



KITC9X9-1

Painel anti-salpicos, 90x75 cm, aço inoxidável, adequado para fogões Portofino, Master e Sinfonia



KITPAX

Altura pés de extensão (950 mm), em aço inoxidável, adequado para fogões Master, Sinfonia e Concerto

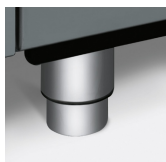

KITPD

Extensão de altura pés pretos (950 mm) para fogões



PPR9

Pedra para pizza refratária sem pegas. Pedra em forma quadrada: L64xH2,3xP37,5 cm Adequada também para fornos a gás, para ser colocada na grelha.



SMOLD

Conjunto de 7 moldes de silicone para sorvetes, gelados, pralinés, cubos de gelo ou para porção de alimentos. Utilizável de -60°C a +230°C

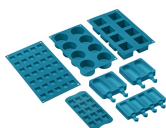

BBQ9



BN940

GTT

** Guias telescópicas totalmente extraíveis (1 nível)** Extração: 433 mm
Material: Aço inoxidável AISI 430 polido



KITH95CPF9

Kit extensão de altura (950 mm), adequado para fogões Portofino



KITPBX

Pés de redução de altura (850 mm)



PALPZ

Pá para pizza com alça dobrável largura: 315mm comprimento : 325mm



SFLK1

Bloqueio para crianças



TPKCPF9

Placa grelhadora Teppanyaki, adequada para fogões Portofino



WOKGHU

Suporte de ferro fundido para WOK



Symbols glossary



Tecnologia Triple Fan: O forno está equipado com um exclusivo sistema de três ventiladores, que, combinado com o aumento da potência dos motores, permite um excelente desempenho culinário. Os dois grandes ventiladores laterais distribuem o ar em torno do perímetro externo da cavidade, enquanto o ventilador central menor aumenta a ventilação, criando um vórtice vertical de calor. Consequentemente, a temperatura dentro da cavidade é uniforme, permitindo que os alimentos sejam cozidos uniformemente em todos os cinco níveis, como nas cozinhas profissionais.



A+: A classe de eficiência energética A+ ajuda a economizar até 10% de energia em comparação com a classe A. O desempenho máximo com consumo mínimo é garantido.



Controle dos botões



Descongelação pelo tempo: com esta função, o tempo de descongelamento dos alimentos é determinado automaticamente.



Portas envidraçadas triplas: Número de portas envidraçadas.



Circogas: Em fornos a gás, o ventilador distribui o calor de forma rápida e uniforme por toda a cavidade do forno, evitando a transferência de sabor ao cozinhar vários pratos diferentes ao mesmo tempo. Em fornos elétricos, esta combinação completa o cozimento mais rapidamente de alimentos que estão prontos na superfície, mas que exigem mais cozimento no interior, sem mais escurecimento.



Somente elementos superior e inferior: um método de cozimento tradicional mais adequado para itens individuais localizados no centro do forno. A parte superior do forno será sempre mais quente. Ideal para assados, bolos de frutas, pão, etc.



Suportes de ferro fundido para serviço pesado: para máxima estabilidade e resistência.



Instalação em coluna: Instalação em coluna



Sistema de arrefecimento a ar: para garantir temperaturas de superfície seguras.



Descongelação pelo peso: Com esta função, o tempo de descongelamento é determinado



Interior esmaltado: O interior em esmalte de todos os fornos Smeg tem um revestimento antiácido especial que ajuda a manter o interior limpo, reduzindo a quantidade de gordura de cozimento aderente a ele.



Ventilador com elementos superiores e inferiores: Os elementos combinados com o ventilador visam fornecer calor mais uniforme, um método semelhante ao cozimento convencional, de modo que o pré-aquecimento é necessário. Mais adequado para itens que exigem métodos de cozimento lento.



Apenas elemento de aquecimento inferior: Esta função é ideal para alimentos que exigem uma temperatura de base extra sem escurecimento, por exemplo, pratos de pastelaria, pizza. Também adequado para cozinhar lentamente ensopados e caçarolas.



Circulaire: A combinação do ventilador e do elemento circular em torno dele dá um método de cozimento de ar quente. Isso oferece muitos benefícios, incluindo nenhum pré-aquecimento se o tempo de cozimento for superior a 20 minutos, nenhuma transferência de sabor ao cozinhar alimentos diferentes ao mesmo tempo, menos energia e tempos de cozimento mais curtos. Bom para todos os tipos de alimentos.



Elemento de grelha O uso de grelha dá excelentes resultados ao cozinhar carne de porções médias e pequenas, especialmente quando combinada com uma rotisseria (sempre que possível). Também é ideal para cozinhar salsichas e bacon.



Circulaire com elementos superior e inferior: O uso do ventilador com ambos os elementos permite que os alimentos sejam cozinhados de forma rápida e eficaz, ideal para grandes peças que exigem cozimento completo. Oferece um resultado semelhante ao da rotisseria, movendo o calor em torno do alimento, em vez de mover o próprio alimento, permitindo que qualquer tamanho ou forma seja cozida.



O vidro interior da porta: pode ser removido com alguns movimentos rápidos para limpeza.



Abertura automática: alguns modelos têm porta de abertura automática quando o ciclo é terminado, o que é uma solução perfeita para unidades de cozinha sem alça, pois nenhuma alça é necessária. Por razões de segurança, a porta trava automaticamente quando a máquina está em uso para evitar que seja aberta inadvertidamente.



Sábado Esta função permite cozinhar alimentos durante o sábado, o feriado de descanso na religião judaica, respeitando os preceitos. O forno funciona



Fechamento suave: todos os modelos estão equipados com função avançada de fechamento suave da porta, o que permite que o dispositivo feche suave e silenciosamente.



Grelha basculante: a grelha basculante pode ser facilmente desengatada para mover o elemento de aquecimento e limpar o tejadilho do aparelho em um simples passo.



ECO: A combinação da grelha, ventilador e elemento inferior é particularmente adequada para cozinhar pequenas quantidades de alimentos.



Ventilador com elemento de grelha: O ventilador reduz o calor feroz da grelha, proporcionando um excelente método de grelhar vários alimentos, costeletas, bifes, salsichas, etc. dando o mesmo escurecimento e distribuição de calor, sem secar os alimentos. Os dois níveis superiores recomendados para uso e a parte inferior do forno podem ser usados para manter os itens quentes ao mesmo tempo, uma excelente facilidade ao cozinhar um café da manhã grelhado. Meia grelha (apenas porção central) é ideal para pequenas quantidades de alimentos.



Toda a porta interna de vidro: Toda a porta interna de vidro, uma única superfície plana que é simples de manter limpa.



Luzes laterais: Duas luzes laterais opostas aumentam a visibilidade dentro do forno.



O ar a 40°C proporciona o ambiente perfeito para levedação de misturas de massa do tipo lêveda. Simplesmente selecione a função e coloque a massa no compartimento previsto



O compartimento do forno tem 5 níveis de cozimento diferentes.



Comando eletrônico. Permite manter a temperatura no interior do forno com a precisão de 2-3 ° C. Isso permite cozinhar refeições que são muito sensíveis a mudanças de temperatura, como por ex. bolos, suflês, pudins.



Queimadores ultrarrápidos: Queimadores ultrarrápidos potentes oferecem até 5kw de potência.



Limpeza a Vapor: uma função de limpeza simples que utiliza vapor para afrouxar os depósitos no compartimento do forno.



A capacidade indica a quantidade de espaço útil no compartimento do forno em litros.



...

Benefit (TT)

Gas hob

Gas provides permanent control of the heat source and the temperature change is immediate

Equipped with a thermocouple, the gas supply is cut off if the flame is extinguished for greater safety.

Vapor Clean

By inserting water into a recess at the bottom of the cavity, steam is generated, which softens the residue and facilitates its removal

By inserting water into a recess at the bottom of the cavity, steam is generated, which softens the residue and facilitates its removal.

LCD display

Easy and intuitive user-experience and cook with a simple touch

Push-pull storage compartment

More space thanks to the lower push-pull compartment, ideal for storing accessories or cooking utensils

True-convection

The best cooking performances guaranteed by ventilated circular flow

Multiple fans and heating elements guarantee the perfect aerodynamic heat flow, allowing homogeneous and quicker cooking inside the cavity.

Multilevel cooking

Several cooking levels allow maximum flexibility of use

Multilevel halogen light

Internal halogen lighting on different levels guarantees excellent visibility

Removable inner glass

Internal door glasses are easily removable for complete cleaning

Tangential cooling

New cooling system with tangential fan and airflow from the door to the splashback

Electronic control

Electronic control for timely temperature management and heat uniformity

Isothermic Cavity

The best cooking performance at the highest energy efficiency

BBQ (optional accessory)

Barbeque cooking directly in the oven with the double-sided grill (BBQ optional accessory)

Pizza stone (optional accessory)

Baking with refractory stone for soft and crispy pizza and yeast products (STONE optional accessory)

Cold door

During any function, the external door glass is cold, avoiding any risk of burns

AirFry (AIRFRY optional accessory)

Lighter and tastier food thanks to airfry basket (optional accessory)

Adjustable height

Cooker top flushed with the working area thanks to adjustable feet

Soft close

The door is equipped with a specific system for silent closing

Triple Turbine

The oven has three fans and two circular heating elements, allowing cooking with rotating heat

Sabbath mode

Possibility of cooking food in compliance with the provisions of the Jewish religious holiday of rest, thanks to Sabbath mode