

CPF9GPBL

Rozmiar	90x60 cm
Liczba komór z etykietą energetyczną	1
Cavity heat source	Elektro
Rodzaj płyty	Gazowa
Typ głównego piekarnika	Termoobieg
Sposób czyszczenia	Pirolityczny
Kod EAN	8017709229412
Klasa efektywności energetycznej	A+



Linia wzornicza













Design	Flush fit	Kolor pokręteł	Stal nierdzewna
Wykończenie panelu sterowania	Metal emaliowany	Liczba pokręteł	8
Linia wzornicza	Portofino	Kolor nadruku	Srebrny
Logo	Assembled st/steel	Wyświetlacz	TFT
Kolor	Czarny	Drzwi	Z panelem
Położenie logo	Panel poniżej piekarnika	Rodzaj szkła piekarnika	Szary
Tylny panel	Tak	Uchwyt	Smeg Portofino
Kolor płyty kuchennej	Stal nierdzewna	Kolor uchwytu	coloured
Materiał rusztów	Żeliwo	Schówek	Push pull
Rodzaj sterowania	Pokręta	Nóżki	Czarny
Pokręta	Smeg Portofino	Cokół	Czarny

Programy / Funkcje



Liczba funkcji pieczenia	10
--------------------------	----

Funkcje pieczenia

 Grzałka górna i dolna	 Obieg powietrza	 Termoobieg
 Turbo	 ECO	 Mały grill
 Duży grill	 Grill + obieg powietrza	 Grzałka dolna
		

Grzałka dolna + obieg powietrza

Pozostałe funkcje

 Rozmrażanie przez podanie czasu	 Rozmrażanie przez podanie wagi	 Wyrastanie ciasta
--	--	---

 Szabat

Funkcje czyszczenia

 Piroliza	 Eco piroliza
---	--

Programy automatyczne 20

Charakterystyka techniczna - Płyta

UR

Liczba wszystkich stref grzejnych 6

Przedni lewy - Gaz - Ultra szybki (podwójny) - 4.20 kW

Tylny lewy - Gaz - Pomocniczy - 1.00 kW

Przedni centralny - Gaz - Pomocniczy - 1.00 kW



















Tylny centralny - Gaz - Średnio szybki - 1.80 kW

Przedni prawy - Gaz - Średnio szybki - 1.80 kW

Tylny prawy - Gaz - Szybki - 3.00 kW

Rodzaj palników gazowych	Standardowe	Zabezpieczenie przeciwwypływowe gazu	Tak
Zapalarka elektryczna zintegrowana w pokrętle	Tak	Nakładki na palniki	Emaliowane, czarny mat

Charakterystyka techniczna - Główny piekarnik

																																																																																																																																																																																																																																																																																					
--	---	---	---	---	---	---	---	---	---	---	---	--	---	---	---	---	---	---	---	---	---	---	---	---	---	---	---	---	---	---	---	---	---	---	---	---	---	---	---	---	---	---	---	---	---	---	---	---	---	---	---	---	---	---	---	---	---	---	---	---	---	---	---	---	---	---	---	---	---	---	---	---	---	---	---	---	---	---	---	---	---	---	---	---	---	---	---	---	---	---	---	---	---	---	---	---	---	---	---	---	---	---	---	---	---	---	---	---	---	---	---	---	---	---	---	---	---	---	---	---	---	---	---	---	---	---	---	---	---	---	---	---	---	---	---	---	---	---	---	--	--	--	--	--	--	--	--	--	--	--	--	--	--	--	--	--	--	--	--	--	--	--	--	--	--	--	--	--	--	--	--	--	--	--	--	--	--	--	--	--	--	--	--	--	--	--	--	--	--	--	--	--	--	--	--	--	--	--	--	--	--	--	--	--	--	--	--	--	--	--	--	--	--	--	--	--	--	--	--	--	--	--	--	--	--	--	--	--	--	--	--	--	--	--	--	--	--	--	--	--	--	--	--	--	--	--	--	--	--	--	--	--	--	--	--	--	--	--	--	--	--	--	--	--	--	--	--	--	--	--	--	--	--	--	--	--	--

Materiał wewnętrznej komory	Emalia Ever Clean	Automatyczne wyłączenie elementów grzejnych po otwarciu drzwi	Tak
Liczba poziomów pieczenia	5	System chłodzący	Statyczny
Rodzaj prowadnic	Prowadnice metalowe	Blokada drzwi podczas czyszczenia pirolitycznego	Tak
Rodzaj oświetlenia	Halogenowe	Wymiary wnętrza komory (wxsxg)	371x724x418 mm
Moc oświetlenia	40 W	Kontrola temperatury	Elektroniczny
Programator czasu gotowania	Start i Stop	Moc grzałki dolnej	1700 W
Oświetlenie przy otwartych drzwiach	Tak	Moc grzałki górnej	1200 W
Otwieranie drzwi	Do dołu	Moc grzałki grilla	1700 W
Łatwy demontaż drzwi piekarnika	Tak	Moc dużego grilla	2900 W
W pełni przeszklona wewnętrzna powierzchnia drzwi	Tak	Moc grzałki pierścieniowej	2 x 1850 W
Łatwy demontaż wewnętrznej szyby drzwi piekarnika	Tak	Rodzaj grilla	Elektryczny
		Zawiasy Soft Close	Tak

Opcje głównego piekarnika

Timer	Tak	Minimalna temperatura	50 °C
Sygnal dźwiękowy zakończenia pieczenia	Tak	Maksymalna temperatura	260 °C

Akcesoria w standardzie Główny piekarnik



Metalowe drabinki boczne	1	Ruszt do blachy	1
Blacha do pieczenia 20mm	1	Prowadnice teleskopowe z częściowym wysuwem	1
Głęboka blacha emaliowana (40 mm)	1		

Podłączenie elektryczne

Moc przyłączeniowa	4000 W	Przewód testowy	Tak, jednofazowy
Natężenie prądu (A)	18 A	Dodatkowe możliwości podłączenia	Tak, dwu- i trójfazowe
Napięcie	220-240 V	Częstotliwość	50/60 Hz
Napięcie 2 (V)	380-415 V	Puszka elektroinstalacyjna	5 biegunowy
Electric cable	Tak, jednofazowy	Wtyczka	Nie

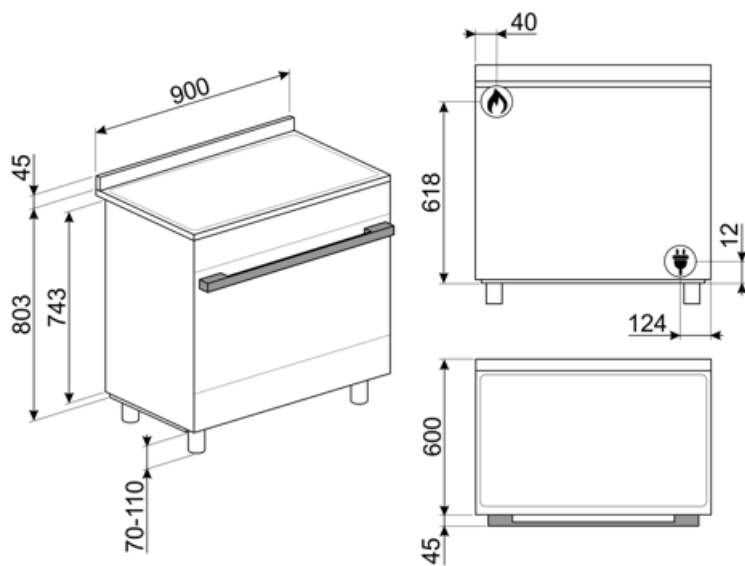

Kompatybilne Akcesoria

AIRFRY9

Ruszt AIRFRY. Idealny do stworzenia tradycyjnego smażenia w piekarniku, ale z mniejszą ilością kalorii i tłuszczu. Pozwala szybko i prosto przyrządzić takie potrawy jak frytki, smażone warzywa i ryby, zapewniając idealne zbrązowienie i chrupkość.



BN920

Enamelled tray 90cm cavity, 20mm deep



GTP

Prowadnice teleskopowe z częściowym wysuwem (1 poziom) Wysuw: 300 mm
Materiał: Stal nierdzewna AISI 304, polerowana



KIT600CPF9P

Listwa maskująca do tylnej strony płyty grzewczej, do kuchni wolnostojącej z pyrolizą 90 cm Portofino



KITPBX

Nóżki zmniejszające wysokość (84,5-85,6 cm)



KITPD

Nóżki do zwiększania wysokości (950 mm), do kuchni wolnostojącej, czarny



PALPZ

Łopata do pizzy ze składaną rączką. Wymiary (SxG): 31,5x32,5 cm. Łatwa i wygodna w użyciu i przechowywaniu. Idealna do serwowania pizzy, chleba i wyśmienitych ciast w bezpieczny i profesjonalny sposób.



BBQ9

teflon-coated aluminum grid for 90 cm cavity



BN940

Enamelled tray 90 cm, 40 mm deep



GTT

Prowadnice teleskopowe z pełnym wysuwem (1 poziom). Wysuw: 433 mm. Materiał: Stal nierdzewna AISI 304, polerowana.



KITH95CPF9

Zestaw do zwiększania wysokości (950 mm), trzy strony, czarny z nóżkami



KITPC9X9

Płyta przeciwtłuszczowa, 90 cm, do kuchni wolnostojącej z pyrolizą Portofino i Symfonia



KITSB9MB



SFLK1

Blokada bezpieczeństwa





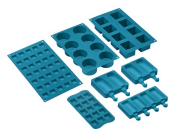































SMOLD



Zestaw 7 silikonowych foremek do lodów, lodowych lizaków, pralin, kostek lodu lub do porcjowania żywności.
Możliwość stosowania od -60°C do +230°C

Słowniczek oznaczeń

 <p>Technologia 3 wentylatorów: piekarnik został wyposażony w system 3. wentylatorów, który w połączeniu ze zwiększoną mocą pozwala na osiągnięcie doskonałych rezultatów pieczenia.</p>	 <p>Wytrzymałe żeliwne ruszty: dla maksymalnej stabilności i wytrzymałości.</p>
 <p>A+: Klasa efektywności energetycznej, mierzona od A+++ do G, w zależności od rodziny produktów.</p>	 <p>Instalacja w kolumnie</p>
 <p>Sterowanie pokrętłami</p>	 <p>Obwodowy system chłodzący</p>
 <p>Rozmrażanie przez podanie czasu: Funkcja ręcznego rozmrażania. Po zakończeniu ustawionego czasu trwania funkcja zatrzymuje się.</p>	 <p>Rozmrażanie przez podanie wagi: Automatyczna funkcja rozmrażania pozwalająca na wybranie rodzaju oraz wagi produktu. Dzięki temu piekarnik automatycznie dobiera czas trwania programu.</p>
 <p>Wyświetlacz CompactScreen</p>	 <p>Liczba szyb w drzwiach: 4 szyby</p>
 <p>Emalia Ever Clean: Emalia Ever Clean nakładana jest elektrostacyjnie, narożnik do narożnika i krawędź do krawędzi, co zapobiega powstawaniu rys i pęknięć z upływem czasu. Jest to szczególna emalia pirolityczna, oporna na działanie kwasów, która oprócz przyjemnego blasku, dzięki mniejszej porowatości, sprzyja łatwieszemu czyszczeniu ścian piekarnika. Jest ona wypalana w temperaturze ponad 850°C i powoli polimeryzowana w naukowo ustalonym tempie, aby zapewnić jednolitą głębokość i wytrzymałość Emalia Ever Clean tworzy nienaganne wykończenie zarówno wewnątrz piekarnika, jak i na blachach, sprawiając, że powierzchnie piekarnika są niezwykle łatwe w utrzymaniu przez długi czas, ponieważ ogranicza przywieranie tłuszczu podczas gotowania.</p>	 <p>Obieg powietrza + grzałka dolna</p>
 <p>Obieg powietrza + grzałka górna i dolna</p>	 <p>Grzałka górna i dolna</p>
 <p>Grzałka dolna</p>	 <p>Termoobieg</p>
 <p>Eco</p>	 <p>Grill</p>
 <p>Mały grill</p>	 <p>Grill z obiegiem powietrza: bardzo intensywne ciepło pochodzące tylko z góry z podwójnego elementu grzewczego. Wentylator jest aktywny. Umożliwia optymalne grillowanie najgrubszych mięs. Idealny do dużych kawałków mięsa.</p>
 <p>Turbo</p>	 <p>W pełni szklana wewnętrzna powierzchnia drzwi. Rozwiązanie to pozwala utrzymać wewnętrzną część drzwi piekarnika w idealnej czystości.</p>

-  Demontowalne wewnętrzne szkło drzwi: Łatwy demontaż wewnętrznego szkła drzwi znacznie ułatwia utrzymanie urządzenia w czystości.
-  Automatyczne otwieranie: niektóre modele mają automatycznie otwierane drzwi po zakończeniu cyklu, co jest doskonałym rozwiązaniem dla kuchni bez uchwytów, ponieważ nie jest potrzebny żaden uchwyt. Ze względów bezpieczeństwa drzwi blokują się automatycznie, gdy urządzenie jest w użyciu, aby uniknąć ich przypadkowego otwarcia.
-  Piroliza eco: Funkcję czyszczenia pirolitycznego Eco można wybrać w przypadku, gdy w piekarniku występuje lżejsze nagromadzenie zanieczyszczeń. Czas działania tej funkcji wynosi maksymalnie 1,5 godziny.
-  Szabat: Ta funkcja pozwala na pieczenie potraw respektując zasady żydowskiego święta szabat.
-  Soft close: wszystkie modele wyposażone są w zaawansowaną funkcję płynnego zamykania drzwi, dzięki której urządzenie zamyka się płynnie i cicho.
-  Elektroniczne sterowanie temperaturą: Funkcja pozwala na utrzymanie temperatury we wnętrzu piekarnika w granicach o tolerancji 2-3 °C. Umożliwia to przyrządzenie dań wrażliwych na zmiany temperatury np. ciast, sufletów lub puddingów.
-  Pojemność 115 l
-  Światła boczne: Dwa przeciwległe światła boczne zwiększają widoczność wewnątrz piekarnika.
-  PIROLIZA - FUNKCJA AUTOMATYCZNEGO CZYSZCZENIA: piekarnik nagrzewa się do temperatury zbliżającej się do 500°C i zwęglą tłuszcz oraz resztki jedzenia w drobny popiół, który można łatwo wytrzeć wilgotną szmatką. Przy tak wysokiej temperaturze, drzwi blokują się automatycznie dla bezpieczeństwa, podczas gdy temperatura drzwi pozostaje bezpieczna w dotyku. Funkcja regulowana przez użytkownika w oparciu o poziom zabrudzeń obecnych w piekarniku.
-  Wyrastanie ciasta: W piekarniku utrzymywana jest temperatura 40°C, która stwarza idealne warunki do wyrastania ciasta.
-  Komora piekarnika posiada pięć poziomów.
-  Prowadnice teleskopowe: Łatwe w instalacji prowadnice teleskopowe znacznie ułatwiają wyciąganie potraw z piekarnika.
-  Potężne palniki ultra rapid oferują do 5 kW mocy.