

CPF9IPOG

Categorie fornuis	90x60 cm
Aantal ovens met energielabel	1
Cavity heat source	Elektrisch
Type kookplaat	Inductie
Type primaire oven	Thermogeventileerd
Reinigingssysteem primaire oven	Pyrolyse
EAN-code	8017709240745
Energie-efficiëntieklasse	A+



Design



Design	Flush fit	Aantal bedieningsknoppen	7
Afwerking bedieningspaneel	Gekleurd plaatstaal	Kleur serigrafie	Zwart
Esthetiek	Portofino	Display	TFT
Logo	Assembled st/steel	Deur	Met kader
Kleur	Groen	Type glas	Grijs
Positie logo	Strook onder de oven	Handgreep	Smeg Portofino
Opstand	Ja	Kleur handgreep	Gekleurd
Kleur kookplaat	Roestvrij staal	Opbergruimte	Push pull
Type bediening	Bedieningsknoppen	Pootjes	Zwart
Bedieningsknoppen	Smeg Portofino	Plint	Zwart
Kleur knoppen	Roestvrij staal		

Programma's / functies

Aantal kookfuncties	10
---------------------	----

Traditionele kookfuncties

- Statisch
- Geventileerd
- Circulaire
- Turbo
- ECO
- Kleine grill
- Grote vlak-grill
- Fan grill (large)
- Base
- Fan assisted base

Overige functies

- Ontdooien op tijd
- Ontdooien op gewicht
- Rijsfunctie
- Sabbath

Schoonmaak functie

- Pyrolytic
- Pyrolytic eco

Automatische programma's 20

Technische specificaties kookplaat



Totaal aantal kookzones 5

- Linksvoor - Inductie - enkel - 1.40 kW - Booster 2.20 kW - Ø 14.5 cm
- Linksachter - Inductie - enkel - 1.85 kW - Booster 3.00 kW - Ø 18.0 cm
- Midden - Inductie - enkel - 2.60 kW - Booster 3.70 kW - Ø 27.0 cm
- Rechtsachter - Inductie - enkel - 2.30 kW - Booster 3.70 kW - Ø 21.0 cm
- Rechtsvoor - Inductie - enkel - 1.40 kW - Booster 2.20 kW - Ø 14.5 cm

Automatische stop bij oververhitting	Ja	Indicator geselecteerde zone	Ja
Automatische aanpassing panafmeting	Ja	Restwarmte indicator	Ja
Indicator minimaal te gebruiken diameter	Ja		

Technische specificaties primaire oven



Aantal lampen	2	Aantal ruiten ovendeur	4
Aantal ventilatoren	3	Aantal thermo-reflecterende ruiten	3
Netto inhoud	115 l	Veiligheidsthermostaat	Ja
Bruto inhoud 1e oven	129 l		
Materiaal ovenruimte	Ever Clean emaille		
Aantal kookniveaus	5		

Type ovenrekken	Metalen zijsteunen	Automatische uitschakeling	Ja
Soort verlichting	Halogeen	verhittingselementen bij	
Vermogen lamp	40 W	openen deur	
Instelling kooktijd	Start en stop	Koelsysteem	Mantelkoeling
Automatische inschakeling verlichting bij openen deur	Ja	Deurblokkering tijdens pyrolyse	Ja
Deur openen	naar beneden	Afmetingen bruikbare interne ovenruimte (hxbxd)	371x724x418 mm
Uitneembare ovendeur	Ja	Temperatuurregeling	Elektronisch
Volledig glazen binnendeur	Ja	Onderwarmte - vermogen	1700 W
Uitneembaar glas binnendeur	Ja	Bovenwarmte - vermogen	1200 W
		Grill - vermogen	1700 W
		Grote vlakgrill - vermogen	2900 W
		Circulatie - vermogen	2 x 1850 W
		Type grill	Elektrisch
		Soft close systeem	Ja

Opties primaire oven

Timer	Ja	Minimum temperatuur	50 °C
Akoestisch signaal einde kooktijd	Ja	Maximum temperatuur	260 °C

Meegeleverde accessoires primaire oven en kookplaat



Rek met achter- en zijstop	1	Inzetrooster	1
Bakplaat (20 mm)	1	Telescopische geleiders, gedeeltelijk uitschuifbaar	1
Bakplaat (40 mm)	1		

Elektrische aansluiting

Aansluitwaarde	11400 W	Type stroomkabel	Double and Three Phase
Stroom	50 A	Frequentie	50/60 Hz
Spanning	220-240 V	Aansluitkast	5 polig
Spanning 2 (V)	380-415 V	Stekker	Nee
Electric cable	Installed, Single phase		



Compatibele Accessoires

AIRFRY9

Air fryer rack AIRFRY . Ideal for recreating traditional frying in the oven, but with fewer calories and less fat. It allows you to cook quickly and simply dishes such as French fries, fried vegetables and fish, ensuring perfect browning and crispiness.



BN920

Enamelled tray 90cm cavity, 20mm deep



GRILLPLATE

Universal griddle for induction, gas, ceramic and electric hobs. Non-stick surface ideal for cooking meat, cheese and vegetables. Dimensions: 410 x 240 mm.



GTT

Volledig uittrekbare telescopische geleiders (1 niveau)



KITH95CPF9

Height extension kit with plinth, (950mm), three sides, black with feet, suitable for CPF9 Portofino and Sinfony C9 cookers



KITPC9X9

Splashback, 90 cm, for Sinfonia and Portofino pyrolytic cookers



PALPZ

Pizzaschep met inklapbare handgreep breedte: 315 mm lengte: 325 mm



BBQ9

teflon-coated aluminum grid for 90 cm cavity



BN940

Enamelled tray 90 cm, 40 mm deep



GTP

Gedeeltelijk uittrekbare telescopische geleiders (1 niveau)



KIT600CPF9P

Cover strip for hob back side, suitable for 90 cm Portofino cookers with piro oven



KITPBX

Height reduction feet (850mm), st/steel, for Sinfonia and Master cookers (845-856mm)



KITPD

Hoogte uitbreidingsset (max. 15cm) zwart



SCRP

Inductie- en keramische kookplaten en teppanyaki-schraper





SFLK1
Kinderslot





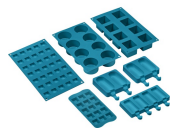











TPKPLATE
Universal plate for induction, gas, ceramic and electric hobs. Non-stick surface ideal for cooking fish, eggs and vegetables. Dimensions: 410 X 240 mm.



SMOLD
Set van 7 siliconen vormpjes voor ijsjes, ijslolly's, pralines, ijsblokjes of om etenswaren te portioneren. Bruikbaar van -60 ° C tot + 230 ° C

Symbols glossary

- | | |
|---|---|
|  <p>Triple Fan-technologie: de oven is uitgerust met een exclusief systeem met drie ventilatoren, dat in combinatie met het verhoogde vermogen van de motoren, uitstekende kookprestaties mogelijk maakt. De twee grote zijventilatoren verdelen de lucht rond de buitenomtrek van de oven, terwijl de kleinere centrale ventilator de ventilatie verhoogt door een verticale werveling van warmte te creëren. Dienovereenkomstig is de temperatuur in de oven gelijkmatig, waardoor voedsel gelijkmatig kan worden gegaard op alle vijf niveaus, zoals in professionele keukens.</p> |  <p>A +: Energie-efficiëntieklasse A + helpt om tot 10% energie te besparen in vergelijking met klasse A. Maximale prestaties bij minimaal verbruik zijn gegarandeerd.</p> |
|  <p>Installation in column: Installation in column.</p> |  <p>Knobs control</p> |
|  <p>Luchtkoelsysteem: om een veilig oppervlak te garanderen temperaturen.</p> |  <p>Ontdooien op tijd: met deze functie wordt automatisch het tijdstip van ontdooien van voedsel bepaald</p> |
|  <p>Ontdooien op gewicht: Met deze functie wordt de ontdooitijd bepaald</p> |  <p>With a simple and intuitive interface, the COMPACTscreen provides a pleasant user experience, thanks to the interaction with the knobs.</p> |
|  <p>Viervoudige beglazing: aantal glazen deuren.</p> |  <p>Geëmailleerde binnenkant: De geëmailleerde binnenkant van alle Smeg-ovens heeft een speciale antacidumvoering die helpt om de binnenkant schoon te houden door de hoeveelheid kookvet te verminderen.</p> |
|  <p>Fan assisted base: the mix of fan and lower heating element alone allows to finish cooking foods already cooked on the surface but not internally more quickly. This system is recommended to finish cooking foods that are already well cooked on the surface, but not internally, which therefore require a moderate higher heat. Ideal for any type of food.</p> |  <p>Ventilator met bovenste en onderste elementen: de elementen in combinatie met de ventilator zijn bedoeld om een meer gelijkmatige warmte te bieden, een methode die vergelijkbaar is met conventioneel koken, dus voorverwarmen is vereist. Het meest geschikt voor items die langzaam koken vereisen.</p> |
|  <p>De ovenruimte wordt tegelijk door het onder- en bovinelement verwarmt. De hitteverdeling over het gerecht is afhankelijk van het niveau waarop men dit plaatst. Geschikt voor bakken op 1 niveau. Gerechten: alle ovenschotels, vlees, gevogelte, brood, (gevulde) taarten. Speciaal: gans en eend (bevatten veel vet).</p> |  <p>De ovenruimte wordt uitsluitend verhit door het onderelement. Voor gerechten die een hoge basistemperatuur behoeven, heeft deze bakstand weinig tot geen invloed op de korst aan de bovenzijde. Geschikt voor bakken op 1 niveau, ideaal voor deeggerechten die moeten rijzen (bijv. pizza). Bij gevulde taarten zal de deegbodem beter droog blijven.</p> |



Circulaire: it is the perfect function for cooking all types of dishes in a more delicate way. The heat comes from the back of the oven and is distributed quickly and evenly. The fan is active. It is also ideal for cooking on multiple levels without mixing smells and flavors.



ECO: low energy consumption cooking: this function is particularly suitable for cooking on a single shelf with low energy consumption. It is recommended for all types of food except those that can generate a lot of moisture (for example vegetables). To achieve maximum energy savings and reduce time, it is recommended to put the food in the oven without preheating the cooking compartment.



De warmte wordt geproduceerd door het grill- en bogenelement. Verhitting over het volledige oppervlak. De thermostaat wordt, afhankelijk van het gerecht, in de regel op de maximale stand gezet. Bij een korte baktijd kan de ovendeur gesloten blijven; bij langere baktijd blijft deze gedeeltelijk geopend. Voor vleesgerechten (klein- en middelgroot), vleespennen, vis, groenten, gratineren etc.



De warmte is alleen afkomstig van het grill-element. Verhitting over een kleiner oppervlak. Te gebruiken als de grote vlak-grill, maar voor kleinere hoeveelheden



Ventilator met grillelement: De ventilator vermindert de felle hitte van de grill en biedt een uitstekende methode om verschillende soorten voedsel, karbonades, steaks, worstjes enz. Te grillen, waardoor het gelijkmatig bruin wordt en de warmte wordt verdeeld, zonder het voedsel uit te drogen. De bovenste twee niveaus die voor gebruik worden aanbevolen, en het onderste deel van de oven kunnen worden gebruikt om gerechten tegelijkertijd warm te houden, een uitstekende mogelijkheid bij het bereiden van een gegrild ontbijt. Halve grill (alleen middengedeelte) is ideaal voor kleine hoeveelheden voedsel.



Turbo: the heat comes from 3 directions: above, below and from the back of the oven. The fan is active. It allows quick cooking, even on several shelves without mixing the aromas. Ideal for large volumes or foods that require intense cooking.



Overheat protection: The safety system that automatically turns off the hob in case of overheating of the control unit.



Induction: The work of these hobs is based on the principle of electromagnetic induction. The heat is generated directly in the bottom of the pan during its contact with the hob.



All glass inner door: All glass inner door, a single flat surface which is simple to keep clean.



The inner door glass: can be removed with a few quick movements for cleaning.



verlichting



Automatic opening: some models have Automatic opening door when the cycle is finished which is a perfect solution for handle-less kitchen units as no handle is needed. For safety reasons, the door locks automatically when the machine is in use to avoid it being opened inadvertently.



Wanneer voor deze functie gekozen wordt, zal de binnenzijde van de oven zorgvuldig gereinigd worden bij een temperatuur van 500 graden Celsius. Dit programma zal minimaal 1 uur en 30 minuten duren. Bij een ernstig vervuilde oven is het mogelijk deze programmaduur per minuut aan te passen tot maximaal 3 uur. Zo kan voor iedere vervuiling een aangepast programma ingesteld worden. Tijdens de pyrolyse cyclus kan de ovendeur door het automatische vergrendelingsysteem niet meer geopend worden, wat absolute zekerheid garandeert.



Pyrolytic: The Eco pyrolytic cleaning function can be selected when the oven has a lighter build up of dirt. This function has a maximum duration of 1.5 hours.



Air at 40°C provides the perfect environment for proving yeast type dough mixes. Simply select the function and place dough in the cavity for allotted



Indication of residual heat: After the glass ceramic hob is switched off the residual heat indicator shows which of the heating zones still remains hot. When the temperature drops below 60 ° C, the indicator goes out.



SABBATH: function that allows to cook food respecting Judaism's day of rest provisions.



The oven cavity has 5 different cooking levels.



Soft close: all models are equipped with advanced function of smooth closing of the door, which allows the device to close smoothly and quietly.



Telescopic rails: allow you to pull out the dish and check it without having to remove it from the oven entirely.



Electronic control: Allows you to maintain temperature inside the oven with the precision 2-3 ° C. This enables to cook meals that are very sensitive to temperature changes, such as cakes, souffles, puddings.



The capacity indicates the amount of usable space in the oven cavity in litres.