

CPF9IPYW

Categorie fornuis	90x60 cm
N. of cavities with energy label	1
Cavity heat source	Elektriciteit
Type kookplaat	Inductie
Type primaire oven	Thermogeventileerd
Reinigingssysteem primaire oven	Pyrolyse reiniging
EAN-code	8017709240783
Energie-efficiëntieklasse	A+



Design

			
Design	Flush fit	Aantal bedieningsknoppen	7
Afwerking bedieningspaneel	Gekleurd plaatstaal	Kleur serigrafie	Zwart
Design	Portofino	Display	Touch display
Logo	Assembled st/steel	Deur	Met kader
Kleur	Geel	Type glas	Grijs
Positie logo	Strook onder de oven	Handgreep	Smeg Portofino coloured
Opstand	Ja	Kleur handgreep	Opbergvak met klep
Kleur kookplaat	Inox	Opbergruimte	Zwart
Bediening	Bedieningsknoppen	Pootjes	Zwart
Bedieningsknoppen	Smeg Portofino	Plint	Zwart
Kleur bedieningsknoppen	Inox		

Programma's / Functies

Aantal kookfuncties	10
---------------------	----

Traditionele bereidingsfuncties

Statisch	Geventileerd	Circulatie (ventilator + circulaire)
Turbo	ECO	Kleine grill
Grote grill	Ventilator + grote grill	Onderwarmte
Geventileerde onderwarmte		

Overige functies

Ontdooien op tijd	Ontdooien op gewicht	Rijzen
Sabbath		

Reinigingsfuncties

Pyrolyse	Pyrolyse ECO
----------	--------------

Automatische programma's 20

Technische specificaties kookplaat



Totaal aantal kookzones 5

Linksvoor - Inductie - enkel - 1.40 kW - Booster 2.20 kW - Ø 14.5 cm
 Linksachter - Inductie - enkel - 1.85 kW - Booster 3.00 kW - Ø 18.0 cm
 Midden - Inductie - enkel - 2.60 kW - Booster 3.70 kW - Ø 27.0 cm
 Rechtsachter - Inductie - enkel - 2.30 kW - Booster 3.70 kW - Ø 21.0 cm
 Rechtsvoor - Inductie - enkel - 1.40 kW - Booster 2.20 kW - Ø 14.5 cm

Automatisch uitschakelen i.g.v. oververhitting	Ja	Indicator geselecteerde zone	Ja
Automatische aanpassing panafmeting	Ja	Indicator (lampje) restwarmte	Ja
Indicator minimaal te gebruiken diameter	Ja		

Technische specificaties primaire oven



Aantal lampen	2	Aantal ruiten ovendeur	4
Aantal ventilatoren	3	Aantal thermo-reflecterende ruiten	3
Netto volume 1e oven	115 l	Veiligheidsthermostaat	Ja
Bruto volume, oven 1	129 l		

Materiaal ovenruimte	Ever Clean emaille	Automatische uitschakeling verhittingselementen bij openen deur	Ja
Aantal kookniveaus	5	Koelsysteem	Mantelkoeling
Type ovenrekken	Metalen zijsteunen	Deurblokkering tijdens pyrolyse	Ja
Type licht	Halogeen	Afmetingen bruikbare interne ovenruimte (hxbxd)	371x724x418 mm
Vermogen lamp	40 W	Temperatuurregeling	Elektronisch
Opties bereidingstijdprogrammering	Begin en eind	Onderwarmte - vermogen	1700 W
Automatische inschakeling verlichting bij openen deur	Ja	Bovenwarmte - vermogen	1200 W
Opening deur	Neerwaarts	Grill - vermogen	1700 W
Uitneembare ovendeur	Ja	Grote vlakgrill - vermogen	2900 W
Volledig glazen binnendeur	Ja	Circulatie - vermogen	2 x 1850 W
Uitneembaar glas binnendeur	Ja	Grill type	Elektrisch
		Soft close systeem	Ja

Opties primaire oven

Timer	Ja	Minimum temperatuur	50 °C
Geluidssignaal einde kooktijd	Ja	Maximum temperatuur	260 °C

Meegeleverde accessoires primaire oven en kookplaat



Ovenrooster met stop	1	Inzetrooster	1
Bakplaat (20 mm)	1	Telescopische geleiders, gedeeltelijk uitschuifbaar	1
Bakplaat (40 mm)	1		

Elektrische aansluiting

Nominale aansluitwaarde	11400 W	Type stroomkabel	Double and Three Phase
Stroom	50 A	Frequentie	50/60 Hz
Spanning	220-240 V	Connection box	5 polig
Spanning 2 (V)	380-415 V	Stekker	Nee
Electric cable	Installed, Single phase		



Compatible Accessories

AIRFRY9

Air fryer rack AIRFRY . Ideal for recreating traditional frying in the oven, but with fewer calories and less fat. It allows you to cook quickly and simply dishes such as French fries, fried vegetables and fish, ensuring perfect browning and crispiness.



BN920

Enamelled tray 90cm cavity, 20mm deep



GRILLPLATE

Universal griddle for induction, gas, ceramic and electric hobs. Non-stick surface ideal for cooking meat, cheese and vegetables. Dimensions: 410 x 240 mm.



GTT

Volledig uitschuifbare telescopische rails (1 niveau) voor traditionele ovens (SF-).



KITH95CPF9

Height extension kit with plinth, (950mm), three sides, black with feet, suitable for CPF9 Portofino and Sinfony C9 cookers



KITPC9X9

Splashback, 90 cm, for Sinfonia and Portofino pyrolytic cookers



PALPZ

Pizzapallet inox met plooibaar handvat, 315x325 mm



BBQ9

teflon-coated aluminum grid for 90 cm cavity



BN940

Enamelled tray 90 cm, 40 mm deep



GTP

Partially extractable telescopic guides (1 level), suitable for traditional ovens. Made in stainless steel, they guarantee stability and facilitate the smooth extraction of the trays.



KIT600CPF9P

Cover strip for hob back side, suitable for 90 cm Portofino cookers with piro oven



KITPBX

Height reduction feet (850mm), st/steel, for Sinfonia and Master cookers (845-856mm)



KITPD

Height extension black feet (950 mm), black, suitable for Master, Sinfonia and Portofino 90cm (914-968mm); Height extension black feet (900 mm), black, suitable for Concerto cookers with 850mm height (880-935mm)



SCRP

Schraper voor inductie- en vitrokeramische kookplaten





SFLK1
Child lock





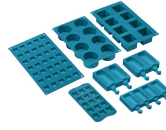











TPKPLATE
Universal plate for induction, gas, ceramic and electric hobs. Non-stick surface ideal for cooking fish, eggs and vegetables. Dimensions: 410 X 240 mm.



SMOLD
Set van 7 siliconen vormen voor ijsjes, pralines, ijsblokjes of porties. -60°C tot 230°C.

Symbols glossary

 <p>De oven is voorzien van een exclusief systeem met 3 ventilatoren, die, gecombineerd met een verhoogd vermogen van de motoren, uitstekende resultaten kan bereiken. De twee grote ventilatoren verdelen de lucht rond de buitenste perimeter van de ovenruimte terwijl de kleinere centrale ventilator de luchtverdeling verhoogt door een verticale vortex van lucht te creëren. Op die manier is de temperatuur in de ovenruimte uniform verdeeld waardoor gerechten op verschillende niveaus op dezelfde manier kunnen bereid worden, zoals in professionele keukens.</p>	 <p>A+: Energy efficiency class A+ helps to save up to 10% energy compared to class A. Maximum performance with minimum consumption is guaranteed.</p>
 <p>Installation in column: Installation in column.</p>	 <p>Knobs control</p>
 <p>Air cooling system: to ensure a safe surface temperatures.</p>	 <p>Defrost by time: Manual defrost function. At the end of the set duration, the function stops.</p>
 <p>Defrost by weight: Automatic defrost function. You choose the type of food to defrost from the available categories (MEAT - FISH - BREAD - DESSERTS). After entering the weight of the food, the oven automatically defines the time required for proper defrosting.</p>	 <p>COMPACTscreen display + bedieningsknoppen</p>
 <p>Quadruple glazed: Number of glazed doors.</p>	 <p>Ever Clean Enamel: Ever Clean enamel is applied electrostatically, corner to corner and edge to edge to prevent cracking or cracks over time. It is a particular pyrolytic enamel, resistant to acids which, in addition to being pleasantly bright, promotes greater cleaning of the oven walls, thanks to its lower porosity. It is baked at over 850 °C and slowly polymerized at a scientifically determined rate to ensure uniform depth and strength. Ever Clean enamel creates an impeccable finish both on the inside of the oven and on the trays, making the surfaces of the oven incredibly easy to maintain over time as it reduces the adhesion of fat during cooking.</p>
 <p>Circogas: In gasovens verdeelt de ventilator de warmte snel en gelijkmatig over de ovenruimte, waardoor smaakoverdracht wordt vermeden bij het tegelijkertijd bereiden van een aantal verschillende gerechten. In elektrische ovens voltooit deze combinatie het koken van voedsel dat aan de oppervlakte klaar is, maar dat van binnen meer moet worden gekookt, zonder verder bruin te worden.</p>	 <p>Ventilator met bovenste en onderste elementen: De elementen in combinatie met de ventilator zijn bedoeld om een meer gelijkmatige warmte te bieden, een methode die vergelijkbaar is met conventioneel koken, dus voorverwarmen is vereist. Het meest geschikt voor items die langzaam koken vereisen.</p>
 <p>Alleen boven- en onder element: een traditionele kookmethode die het meest geschikt is voor losse items in het midden van de oven. de bovenkant van de oven zal altijd het heetst zijn. Ideaal voor gebraden vlees, fruitcake, brood etc.</p>	 <p>Base: the heat comes only from the bottom of the cavity. The fan is not active. Ideal for sweet and savory pies, cobblers and pizzas. Designed to complete cooking and make food more crunchy. This symbol in gas ovens indicates the gas burner.</p>



Circulaire: De combinatie van de ventilator en het ronde element eromheen zorgt voor een hete lucht kookmethode. Dit biedt vele voordelen, waaronder geen voorverwarmen als de kooktijd meer dan 20 minuten bedraagt, geen smaakoverdracht bij het gelijktijdig bereiden van verschillende soorten voedsel, minder energie en kortere kooktijden. Geschikt voor alle soorten voedsel.



Grill: Very intense heat coming only from above from a double heating element. The fan is not active. Provides excellent grilling and gratinating results. Used at the end of cooking, it gives a uniform browning to dishes.



Fan grill: very intense heat coming only from above from a double heating element. The fan is active. It allows the optimal grilling of thickest meats. Ideal for large cuts of meat.



Overheat protection: The safety system that automatically turns off the hob in case of overheating of the control unit.



All glass inner door: All glass inner door, a single flat surface which is simple to keep clean.



Side lights: Two opposing side lights increase visibility inside the oven.



PYROLYSIS - AUTOMATIC CLEANING FUNCTION: the oven heats up to a temperature approaching 500 ° C and chars grease and food residues into a fine ash that can be easily wiped off with a damp cloth. At such a high temperature, the door locks automatically for safety, while the temperature of the door remains controlled so it is safe to touch User adjustable function based on the level of dirt present in the oven.



Air at 40°C provides the perfect environment for proving yeast type dough mixes. Simply select the function and place dough in the cavity for allotted



De combinatie van de grill, de ventilator en onderwarmte is interessant voor het bereiden van kleine hoeveelheden.



Half grill: For rapid cooking and browning of foods. Best results can be obtained by using the top shelf for small items, the lower shelves for larger ones, such as chops or sausages. For half grill heat is generated only at the centre of the element, so is ideal for smaller quantities.



Circulaire met bovenste en onderste elementen: door het gebruik van de ventilator met beide elementen kan voedsel snel en effectief worden gekookt, ideaal voor grote stukken vlees die grondig moeten worden gekookt. Het biedt een vergelijkbaar resultaat als rotisserie, waarbij de warmte rond het voedsel wordt verplaatst in plaats van het voedsel zelf te verplaatsen, waardoor elke maat of vorm kan worden gekookt.



Induction: The work of these hobs is based on the principle of electromagnetic induction. The heat is generated directly in the bottom of the pan during its contact with the hob.



The inner door glass: can be removed with a few quick movements for cleaning.



Automatic opening: some models have Automatic opening door when the cycle is finished which is a perfect solution for handle-less kitchen units as no handle is needed. For safety reasons, the door locks automatically when the machine is in use to avoid it being opened inadvertently.



Pyrolytic: The Eco pyrolytic cleaning function can be selected when the oven has a lighter build up of dirt. This function has a maximum duration of 1.5 hours.



Indication of residual heat: After the glass ceramic hob is switched off the residual heat indicator shows which of the heating zones still remains hot. When the temperature drops below 60 ° C, the indicator goes out.



SABBATH: function that allows to cook food respecting Judaism's day of rest provisions.



Alle modellen zijn voorzien van een soft close deursysteem waarbij de deur zacht en stil sluit.



Electronic control: Allows you to maintain temperature inside the oven with the precision 2-3 ° C. This enables to cook meals that are very sensitive to temperature changes, such as cakes, souffles, puddings.



The oven cavity has 5 different cooking levels.



Telescopic rails: allow you to pull out the dish and check it without having to remove it from the oven entirely.



The capacity indicates the amount of usable space in the oven cavity in litres.